

CODE	COURSE NAME	CATEGORY	L	T	P	CREDIT
EET402	ELECTRICAL SYSTEM DESIGN AND ESTIMATION	PCC	2	1	0	3

Preamble: Electrical System Design would provide general awareness on IS Product standards / Codes of Practice, The Electricity Act 2003, CEA Regulations and Rules, NEC etc. related to Domestic, Industrial and Commercial Installations. It will also help in the design of Main and Sub Switchboards and distribution system for a medium class domestic and industrial electrical installations. Design of lighting system and selection of luminaries. Selection of Underground cables, Standby generators, lifts and with all involved auxiliaries. Design and selection of power distribution system with power and motor loads for a medium industry. Electrical system design for High-rise buildings with rising main/ cable distribution to upper floors including fire pumps. Design of indoor and outdoor 11kV substations including selection of switching and protective devices for an HT consumer. Essential safety requirements for the electrical installations for Recreational buildings.

Prerequisite: Basics of electrical power systems, circuit analysis and fault level calculations.

Course Outcomes: After the completion of the course the student will be able to:

CO 1	Explain the rules and regulations in the design of components for medium and high voltage installations.
CO 2	Design lighting schemes for indoor and outdoor applications.
CO 3	Design low/medium voltage domestic and industrial electrical installations.
CO 4	Design, testing and commissioning of 11 kV transformer substation.
CO 5	Design electrical installations in high rise buildings.

Mapping of course outcomes with program outcomes

	PO 1	PO 2	PO 3	PO 4	PO 5	PO 6	PO 7	PO 8	PO 9	PO 10	PO 11	PO 12
CO 1	3	1	2	-	-	1	-	2	-	-	-	-
CO 2	3	2	3	-	-	1	1	1	-	-	-	1
CO 3	3	1	3	-	-	1	-	1	-	-	-	1
CO 4	3	1	3	-	-	1	-	1	-	-	1	1
CO 5	3	1	3	-	-	1	1	1	-	-	-	1

Assessment Pattern

Bloom's Category	Continuous Assessment Tests		End Semester Examination
	1	2	
Remember (K1)	10	10	20
Understand (K2)	15	15	30
Apply (K3)	25	25	50
Analyse (K4)			
Evaluate (K5)			
Create (K6)			

Mark distribution

Total Marks	CIE	ESE	ESE Duration
150	50	100	3 hours

Continuous Internal Evaluation Pattern:

Attendance	: 10 marks
Continuous Assessment Test (2 numbers)	: 25 marks
Assignment/Case study/Course project	: 15 marks

End Semester Examination Pattern: There will be two parts; Part A and Part B. Part A contains 10 questions with 2 questions from each module, having 3 marks for each question. Students should answer all questions. Part B contains 2 questions from each module of which student should answer any one. Each question can have maximum 2 sub-divisions and carry 14 marks.

Course Level Assessment Questions**Course Outcome 1 (CO1):**

1. Mention the Scope of The Electricity Act 2003 (K1, K2, PO1)
2. Precautions to be followed for electric safety against loss of life and materials (K3, PO2, PO3, PO6)
3. Mention the Scope of IS 732 (K2, PO8)

Course Outcome 2 (CO2)

1. How are the luminaries selected based on the area of application? (K2, PO3, PO3, PO6)
2. What is CRI? (K1, PO1)
3. Parameters taken into consideration while designing street lighting and flood lighting (K3, PO2, PO3, PO7, PO8, PO12)

Course Outcome 3 (CO3):

1. Characteristics of MCBs (K1, PO1, PO3)
2. Grading between MCBs (K2, PO2, PO6, PO8)
3. Electrical Schematic and physical layout drawings of switch boards, DBs, lighting fittings, fans etc.(K3, PO2, PO6, PO8, P12)

Course Outcome 4 (CO4):

1. Selection of transformer substation. (K1, K2, PO1, PO3)
2. Protective switchgear selection and design of earthing. (K3, PO2, PO6, PO8, PO11)
3. Pre-commission tests to be conducted (K3, PO6, PO12)

Course Outcome 5 (CO5):

1. Selection of different electrical components/systems for multi-storeyed buildings (K1, K2, PO1)
2. Fire protection in high rise buildings (K1, K2, PO2, PO6, PO8)
3. The energy conservation techniques (K2, K3, PO2, PO6)

4. PV solar system design (K3, PO3, PO6, PO7, PO12)
5. Functioning of AMF system (K2, PO1)

Model Question Paper

PAGES: 3

QP CODE:

Reg. No: _____

Name: _____

**APJ ABDUL KALAM TECHNOLOGICAL UNIVERSITY
EIGHTH SEMESTER B. TECH DEGREE EXAMINATION
MONTH & YEAR**

Course Code: **EET402**Course Name: **ELECTRICAL SYSTEM DESIGN AND ESTIMATION****Max. Marks: 100****Duration: 3****Hours****PART A****Answer all Questions. Each question carries 3 Marks**

- 1 Describe the scope of NEC with regard to electrical system design.
- 2 What are the 3 phase AC system voltages as per NEC and their permissible limits.
- 3 Explain the specific design considerations in the design of a good lighting scheme.
- 4 List the different types of lamps suitable for street lighting and give their merits and demerits.
- 5 What is load survey and explain its importance in electrical system design.
- 6 Explain the salient aspects considered for the selection of LV/MV cables.
- 7 Explain the working principle of MCB/MCCB and compare MCB and MCCB.
- 8 List out the pre-commissioning tests of 11kV indoor substation of an HT consumer and explain any one method.
- 9 Explain the terms Continuous, Prime and Standby power ratings as applied to a Diesel Generator set.
- 10 Explain the principle of operation of an AMF panel in an electrical system. What is its necessity in an industry?

PART B**Answer any one full question from each module. Each question carries 14 Marks****Module 1**

- 11 a What is standardization, how does NEC assist for the electrical system design. (5)
- b Explain the relevance of the following IS codes: IS 732, IS 3043. (5)
- c Briefly explain the electrical services in buildings. (4)
- 12 a Enumerate any five safety measures incorporated in system design. (5)
- b) Draw the standard graphical symbols as given in NEC for:

i) circuit breaker	ii) star-delta starter	
iii) fuse disconnecter	iv) autotransformer	v) energy meter (5)

- c Explain the scope of the Electricity Act 2003. (4)

Module 2

- 13 a) What are the requirements to be satisfied for good road lighting? How are sources selected for road lighting? (7)
- b) An office room of size 9X15m is to be illuminated by 2x18W LED luminaire. The lamps are being mounted at a height of 3m from the work plane. The average illumination required is 240 lux. Calculate the number of lamps required to be fitted, assuming a CU of 0.75 and a LLF of 0.8. Assume the ceiling height of the room as 5m. Draw the layout of the luminaire arrangement. The lumen output of 2x18W LED may be taken as 4000 lumens. (7)
- 14 a) Briefly explain the working of an LED lamp with circuit diagram. (7)
- b) Design a road way lighting scheme and determine the spacing between the poles using the given lamps. Which alternative you will choose, from the point of energy conservation?

Width of the road way = 12 m
 Illumination required = 15lux
 Mounting height of poles = 9 m
 Arm length = 2m

Types of Lamps	CU	LLF
HPSV - 150 W, 16000 lumen	0.65	0.7
LPSV - 150 W, 25500 lumen	0.5	0.9

The lamps are placed on one side of the road. Assume any missing data. (7)

Module 3

- 15 a) List the pre-commissioning tests for domestic installation and with the help of schematic diagram explain any one test in detail. (4)
- b) Determine the total connected load, number of sub circuits and type of supply for a domestic building with the following rooms: One-bedroom with attached toilet, hall and kitchen (1BHK). Draw the schematic diagram showing the ratings of MCBs and sub circuits. Design shall be based on the NEC guide lines. Assume all required data. (10)
- 16 a) Briefly explain the working of ELCB with a neat connection diagram. (4)
- b) A rest house has four air-conditioned bed rooms with attached toilets, dining hall and kitchen. Prepare the room wise list of electrical materials for the installation. Draw the schematic diagram showing the ratings of MCBs and sub circuits. Design is based on the NEC guide lines. Assume all required data. (10)

Module 4

- 17 a) Explain the criteria for the design of bus-bar system of a Motor Control Centre (MCC). (4)
- b) An industry consists of the following loads:
- 7.5 kW, 3 phase cage induction motor – 1 No.
 - 11.2 kW, 3 phase cage induction motor – 2 Nos.
 - 22.5 kW, 3 phase cage induction motor – 1 No.

- d. Power sockets – 15Nos.
- e. Lighting loads - 40 Nos of 2 x 18 W LED lamps
- f. Exhaust fans 100 W - 4 Nos.

Design the electrical system for the industry, if the industry is located in a village, and also determine:

- i. Type of industry,
 - ii. Transformer capacity required and type of substation, and
 - iii. Draw the single line schematic diagram showing the details of cable size, starters and switch gears. Use a switch board with MCCB/SFU incomer and MCCB/SFU/MCB as outgoing and MCB type distribution board for lighting. (10)
- 18 a) Explain the design procedures of the MSB of an industry with predominantly motor loads. (4)
- b) A factory has the following connected load:
- i. Large motor of 150 kW - 1 no.
 - ii. Machine shop with 7.5 kW motors - 6 nos.
 - iii. Painting booth of 22.5 kW
 - iv. 10 kVA welding transformers - 4 nos.
 - v. Water pumping station load 15 kW
 - vi. Lighting load 5 kW

Select the transformer rating and design an indoor substation including the schematic diagram showing the details of switchgear and cable sizes. Assume a diversity factor of 1.2. (10)

Module 5

- 19 a) Draw the schematic diagram of a 400 A rising main arrangement for a five-storied building also give the rating of floor wise feeders and switchgears. (6)
- b) Briefly explain the sizing of solar PV system for a domestic installation with a daily usage of 5 units. (8)
- 20 a) Draw the electric schematic diagram of a 320 kVA standby DG set with an AMF panel. Explain the essential potential and metering arrangements required in the generator control panel. (6)
- b) Briefly explain the sizing of the battery bank of an off grid solar PV system to cater 3 kWh per day for a domestic installation. (8)

Syllabus

Module 1

IS Product Standards and Codes of practice, The Electricity Act 2003 and NEC 2011 (6 hours):

General awareness of IS Codes - IS 732 - IS 3043 –IS 2026- IS 3646-part 1&2 - IS 5216 part 1&2 - Electricity supply code-2014 (Relevance of each code in electrical installation applications only).

The Electricity Act 2003- General introduction- Distribution of Electricity (Part VI)- Central Electricity Authority (Part IX)- Regulatory Commissions (Part IX).

National Electric Code (NEC 2011) - Scope – Wiring installation (Section 9)- Short circuit calculations (Section 10).

Graphical symbols and signs as per NEC for electrical installations.

Classification of voltages-standards and specifications, tolerances for voltage and frequency.

Module 2

Lighting Schemes and calculations (6 hours):

Lighting design calculations - Definitions of luminous flux, Lumen, Luminous intensity/illuminance (Lux), Illumination calculations, factors affecting Coefficients of Utilisation (CoU) - and Light Loss Factor (LLF).

Benefits of LED lamps over the yesteryear luminaires – Efficacy of present-day LED lamps- Design of illumination systems – Average lumen method - Space to mounting height ratio- Design of lighting systems for a medium area seminar hall using LED luminaires

Exterior lighting design- point to point method - road lighting and public area lighting- Space to mounting height ratio - selection of luminaires- Metal Halide- High & Low pressure Sodium– LED lamps.

Module 3

Domestic Installation (10 hours)

General aspects as per NEC and IS 732 related to the design of domestic dwellings availing single phase supply (LV) and three phase supply (MV) for a connected load less than 15kW.

Load Survey- common power ratings of domestic gadgets- connected load-diversity factor- selection of number of sub circuits (lighting and power)-selection of MCB distribution boards to provide over load, short circuit and earth leakage protection.

Principle of operation of MCB, MCB Isolator, ELCB/RCCB and RCBO. Selection of CBs for protection and grading between major and minor sections.

Selection of wiring cables, conduits as per NEC and IS 732.

Design of electrical schematic and physical layout drawings for low and medium class domestic installation. Preparation of schedule of works and bill of quantities (cost estimation excluded).

Pre-commissioning tests- Insulation resistance measurement, continuity test, polarity test, and earth resistance measurement as applicable to domestic installations.

Module 4

Industrial Power and Lighting Installations (9 hours):

Industrial installations –classifications- Design of electrical distribution systems with main switch board, sub switch boards and distribution boards with ACBs, MCCBs and MCBs as the case may be, for feeding power (mainly motors) and lighting loads of small and medium industries.

Selection of armoured power cables (AYFY, A2XFY, YWY) – calculation of ampacity, voltage drop, short circuit withstand capacity etc.

Design of MSB & SSB including Motor Control Centre (MCC) for motor controls - selection of bus bars and switchgears.

Selection of 11kV indoor and outdoor transformer substations upto 630kVA - selection of switchgears and protective devices –Preparation of schedule of works and bill of quantities (cost estimation excluded).

Short circuit calculations and earthing design for the HV and LV sides of an 11 kV substation of capacity up to 630 kVA.

Pre-commissioning tests of 11kV indoor/outdoor substation of an HT consumer.

Module 5

High Rise building, Solar PV system, Standby generators and Energy conservation (8 hours):

Electrical installations of high-rise buildings: Distribution systems – rising main, cable system - Installation of lifts, standby generators, fire pumps - electric schematic drawing.

Selection of standby Diesel Generator set (DG set) –power rating - Continuous, Prime and Standby power ratings- installation and essential protections-Introduction to Automatic Mains failure (AMF) systems.

Energy Conservation Techniques in electrical power distribution - Automatic Power Factor Correction (APFC) panel – Principle of operation and advantages.

Introduction to Solar PV Systems, off-grid and on-grid systems, Solar panel efficiencies- design of a PV system for domestic application-Selection of battery for off-grid domestic systems.

Data Book (Use for Examination Hall)

1. Data Book Published by the University

Text/Reference Books

1. National Electrical Code 2011, Bureau of Indian Standards.
2. National Lighting Code 2010, Bureau of Indian Standards.
3. National Building Code of INDIA 2016 - Bureau of Indian Standards.
4. M. K. Giridharan, Electrical Systems Design, I K International Publishers, New Delhi, 2nd edition, 2016.
5. U.A.Bakshi, V.U.Bakshi Electrical Technology, Technical publications, Pune.
6. Narang K.L., A Text Book of Electrical Engineering Drawing, Tech India Publications.
7. J. B. Gupta, A Course in Electrical Installation Estimating and Costing, S.K. Kataria & Sons; Reprint 2013 edition (2013).
8. K. B. Raina, S. K. Bhattacharya, Electrical Design Estimating Costing, NEW AGE; Reprint edition (2010).

Website

1. www.price.kerala.gov.in (Reference for module 3 and 4)

Course Contents and Lecture Schedule:

Module	Topic coverage	No. of Lectures
1	IS Codes, Ats, Rules and NEC (6 hours):	
1.1	General awareness of IS Codes - IS 732 - IS 3043 –IS 2026- IS 3646-part 1&2 - IS 5216 part 1&2 - Electricity supply code-2014 (Relevance of each code in electrical installation applications only). The Electricity Act 2003- General introduction- Distribution of Electricity (Part VI)- Central Electricity Authority (Part IX)- Regulatory Commissions (Part IX).	2
1.2	National Electric Code (NEC 2011) - Scope – Wiring installation (Section 9)- Short circuit calculations (Section 10).	2
1.3	Graphical symbols and signs as per NEC for electrical installations. Classification of voltages-standards and specifications, tolerances for voltage and frequency.	2
2	Lighting Schemes and calculations (6 hours):	
2.1	Lighting design calculations - Definitions of luminous flux, Lumen, Luminous intensity/illuminance (Lux), Illumination calculations, factors affecting Coefficients of Utilisation (CoU) - and Light Loss Factor (LLF).	2
2.2	Benefits of LED lamps over the yesteryear luminaires – Efficacy of present-	2

	day LED lamps-Design of illumination systems – Average lumen method - Space to mounting height ratio- Design of lighting systems for a medium area seminar hall using LED luminaires	
2.3	Exterior lighting design- point to point method - road lighting and public area lighting- Space to mounting height ratio - selection of luminaires- Metal Halide- High & Low pressure Sodium– LED lamps.	2
3	Domestic Installation (10 hours):	
3.1	General aspects as per NEC and IS 732 related to the design of domestic dwellings availing single phase supply (LV) and three phase supply (MV) for a connected load less than 15kW.	2
3.2	Load Survey- common power ratings of domestic gadgets- connected load-diversity factor-selection of number of sub circuits (lighting and power)-selection of MCB distribution boards to provide over load, short circuit and earth leakage protection.	2
3.3	Principle of operation of MCB, MCB Isolator, ELCB/RCCB and RCBO. Selection of CBs for protection and grading between major and minor sections. Selection of wiring cables, conduits as per NEC and IS 732.	2
3.4	Design of electrical schematic and physical layout drawings for low and medium class domestic installation. Preparation of schedule of works and bill of quantities (cost estimation excluded). Pre-commissioning tests- Insulation resistance measurement, continuity test, polarity test, and earth resistance measurement as applicable to domestic installations.	4
4	Industrial installations (9 hours):	
4.1	Industrial installations –classifications- Design of electrical distribution systems with main switch board, sub switch boards and distribution boards with ACBs, MCCBs and MCBs as the case may be, for feeding power (mainly motors) and lighting loads of small and medium industries. Selection of armoured power cables (AYFY, A2XFY, YWY) – calculation of ampacity, voltage drop, short circuit withstand capacity etc.	3
4.2	Design of MSB & SSB including Motor Control Centre (MCC) for motor controls - selection of bus bars and switchgears.	2

4.3	<p>Selection of 11kV indoor and outdoor transformer substations upto 630kVA - selection of switchgears and protective devices –Preparation of schedule of works and bill of quantities (cost estimation excluded).</p> <p>Short circuit calculations and earthing design for the HV and LV sides of an 11 kV substation of capacity up to 630 kVA.</p>	3
4.4	Pre-commissioning tests of 11kV indoor/outdoor substation of an HT consumer.	1
5	High Rise building, Solar PV system, Standby generators and Energy conservation (8 hours):	
5.1	Electrical installations of high-rise buildings: Distribution systems – rising main, cable system - Installation of lifts, standby generators, fire pumps - electric schematic drawing.	2
5.2	Selection of standby Diesel Generator set (DG set) –power rating - Continuous, Prime and Standby power ratings- installation and essential protections-Introduction to Automatic Mains failure (AMF) systems.	3
5.3	Energy Conservation Techniques in electrical power distribution - Automatic Power Factor Correction (APFC) panel – Principle of operation and advantages.	1
5.4	Introduction to Solar PV Systems, off-grid and on-grid systems, Solar panel efficiencies-design of a PV system for domestic application-Selection of battery for off-grid domestic systems.	2

Estd.



2014

Assessment Pattern

Bloom's Category	Continuous Assessment Tests		End Semester Examination
	1	2	
Remember	10	10	20
Understand	20	20	40
Apply	20	20	40
Analyse			
Evaluate			
Create			

Mark distribution

Total Marks	CIE	ESE	ESE Duration
150	50	100	3 hours

Continuous Internal Evaluation Pattern:

Attendance : 10 marks

Continuous Assessment Test (2 numbers) : 25 marks

Assignment/Quiz/Course project : 15 marks

End Semester Examination Pattern: There will be two parts; Part A and Part B. Part A contain 10 questions with 2 questions from each module, having 3 marks for each question. Students should answer all questions. Part B contains 2 questions from each module of which student should answer any one. Each question can have a maximum 2 subdivisions and carry 14 marks.

Course Level Assessment Questions**Course Outcome 1 (CO1):**

1. Explain the anatomy of a robot which is used for pick and place tasks. (K2, PO1, PO12)
2. What are the specifications of a typical spray painting robot? (DOF, specialties, control method etc.) (K1, PO2, PO12)

- ELECTRICAL AND ELECTRONICS
3. Which control method is used for a spot welding robot? (Continuous path control or point to point control) (K2, PO2, PO12)

Course Outcome 2 (CO2):

1. Choose a sensor as per robotic application.(K2, PO1, PO12)
2. Describe the functional differences of stepper motors and ac motors.(K1, PO1, PO12)
3. Pneumatic actuators are not suitable for heavy loads under precise control. Justify it.(K2, PO1, PO2, PO12)

Course Outcome 3 (CO3):

1. Explain the features of SCARA, PUMA Robots?(K1, PO1, PO12)
2. What are the different classification of robots based on motion control methods and drive technologies? Explain(K1, PO1, PO2, PO12)
3. What are the factors affecting the selection of grippers?(K1, PO1, PO3, PO12)

Course Outcome 4 (CO4):

1. What do you mean by forward kinematics?(K1, PO1, PO2, PO12)
2. Explain the inverse kinematics of robots.(K1, PO1, PO3, PO12)
3. What are the different coordinate systems used by industrial robots?(K1, PO1, PO3, PO12)

Course Outcome 5 (CO5):

1. Explain about planning the trajectory in Cartesian space and Joint space for robotic manipulators.(K1, PO1, PO2, PO12)
2. Explain about the third order polynomial trajectory planning in Joint space.(K1, PO1, PO2, PO12)
3. A two-degree-of-freedom planar robot is to follow a straight line in Cartesian space between the start (2,6) and the end (12,3) points of the motion segment. Find the joint variables for the robot if the path is divided into 10 segments. Each link is 9 inches long.(K2, PO1, PO3, PO12)

Course Outcome 6 (CO6):

1. Obtain the dynamic model of 1 DOF robot.(K2, PO1, PO2, PO12)
2. Explain the steps to design a PID controller for a single link manipulator.(K2, PO1, PO3, PO12)
3. Write short note on computed torque control.(K1, PO1, PO2, PO12)

Model Question Paper**APJ ABDUL KALAM TECHNOLOGICAL UNIVERSITY
EIGHTH SEMESTER B.TECH. DEGREE EXAMINATION****Course Code: EET414****Course Name: ROBOTICS**

Max. Marks: 100

Duration: 3 Hours

PART A*Answer all questions, each carries 3 marks.*

Marks

- | | | |
|----|--|-----|
| 1 | Define reach and stroke of a robotic manipulator. | (3) |
| 2 | What are the characteristics of a spot welding robot? | (3) |
| 3 | A strain gauge of gauge factor 2 and resistance of the unreformed wire 100Ω is used to measure the acceleration of an object of mass 3kg. If the strain is 10^{-6} , cross sectional area= 10mm^2 and Young's modulus = $6.9 \times 10^{10} \text{N/m}^2$, compute the acceleration of the object. | (3) |
| 4 | Compare hydraulic and pneumatic actuators. | (3) |
| 5 | Explain the features of a SCARA robot. | (3) |
| 6 | What are the advantages and disadvantages of a pneumatic gripper? | (3) |
| 7 | If a point $P = [3 \ 0 \ -1 \ 1]^T$, find the new location of the point P, if it is rotated by π about the z-axis of the fixed frame and then translated by 3 units along the y-axis. | (3) |
| 8 | How will you compute the end effector position and orientation of a robotic arm? | (3) |
| 9 | What is the necessity of dynamic modelling of robotic manipulators? | (3) |
| 10 | Is a robotic system linear or nonlinear? Justify your answer. | (3) |

PART B*Answer any one full question from each module, each carries 14 marks.***MODULE1**

- | | | |
|----|---|------|
| 11 | a) Explain in detail the specifications of a robotic manipulator. | (10) |
|----|---|------|

- b) What is the typical anatomy of a robotic manipulator? (8)
- 12 a) Explain in detail any two industrial applications of Robots. (10)
- b) Compare point to point control and continuous path control. (4)

MODULE II

- 13 a) How will you choose an appropriate sensor for a robotic application? (8)
- b) Mention the applications of vision sensor (6)
- 14 a) Outline the method of varying position using servo motor and stepper motor. (8)
- b) Explain the working of a typical hydraulic actuator. (6)

MODULE III

- 15 a) Explain in detail all robotic configurations. (14)
- 16 a) Describe the types of end effector & gripper mechanisms with simple sketches (14)

MODULE IV

- 17 a) Obtain the forward kinematic model of the following robot (14)

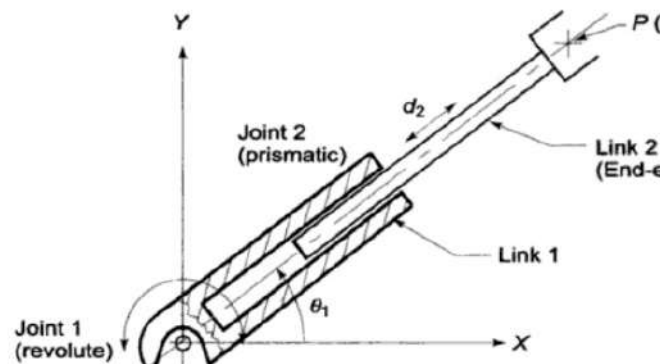

- 18 a) The second joint of a SCARA robot has to move from 15° to 45° in 3 sec. Find the coefficients of the cubic polynomial to interpolate a smooth trajectory. Also obtain the position, velocity and acceleration profiles (8)
- b) How will you plan a straight line trajectory in Cartesian space? (6)

MODULE V

- 19 a) Obtain the dynamic model of 1 DOF robot operated by electric motor. (8)

- b) How will you build a servo controlled robotic arm? (6)
- 20 a) Describe the schematic of PID controlled robotic manipulator and derive the closed loop transfer function. Explain how gains are computed for the PID controller? (10)
- b) Comment on the stability of the above controller (4)

SYLLABUS

Module 1

Definitions- Robots, Robotics; Types of Robots- Manipulators, Mobile Robots-wheeled & Legged Robots, Aerial Robots; Anatomy of a robotic manipulator-links, joints, actuators, sensors, controller; open kinematic vs closed kinematic chain; degrees of freedom; Robot considerations for an application- number of axes, work volume, capacity & speed, stroke & reach, Repeatability, Precision and Accuracy, Operating environment, point to point control or continuous path control.

Robot Applications- medical, mining, space, defence, security, domestic, entertainment, Industrial Applications-Material handling, welding, Spray painting, Machining.

Case study- anatomy and specifications of a typical material handling robot

Module 2

Sensors and Actuators

Sensor classification- Touch, force, proximity, vision sensors.

Internal sensors-Position sensors, velocity sensors, acceleration sensors, Force sensors; External sensors-contact type, non-contact type; Vision - Elements of vision sensor, image acquisition, image processing; Selection of sensors.

Actuators for robots- classification-Electric, Hydraulic, Pneumatic actuators; their advantages and disadvantages; Electric actuators- Stepper motors, DC motors, DC servo motors and their drivers, AC motors, Linear actuators, selection of motors; Hydraulic actuators- Components and typical circuit, advantages and disadvantages; Pneumatic Actuators- Components and typical circuit, advantages and disadvantages.

Case study- sensors and actuators needed for a differential drive robot which is capable of autonomous navigation, study of sensors and actuators for an autonomous pick and place robot

Module 3

Robotic configurations and end effectors

Robot configurations-PPP, RPP, RRP, RRR; features of SCARA, PUMA Robots; Classification of robots based on motion control methods and drive technologies; 3R concurrent wrist;

Classification of End effectors - mechanical grippers, special tools, Magnetic grippers, Vacuum grippers, adhesive grippers, Active and passive grippers, factors affecting selection of grippers.

Case study- typical robotic configuration for a pick and place robot capable picking objects from a moving conveyor

Module 4

Kinematics and Motion Planning

Robot Coordinate Systems- Fundamental and composite rotations, homogeneous coordinates and transformations, Kinematic parameters, D-H representation, Direct Kinematics. The Arm equation- forward and inverse Kinematics of typical robots upto 3 DOF.

Motion Planning- joint space trajectory planning-cubic polynomial, linear trajectory with parabolic blends; Cartesian space planning, Point to point vs continuous path planning.

Case study- Obtain the joint profiles of a 2 DOF planar manipulator, if the end effector is moving through an arc.

Module 5

Dynamics and Control of Robots

Dynamics- Dynamic model of a robot using Lagrange's equation, dynamic modelling of 1 DOF robot.

Control Techniques- Transfer function and state space representation, Performance and stability of feedback control, PID control of a single link manipulator, selection of PID controller gains; nonlinear nature of manipulators, and need for nonlinear control techniques, Computed torque control.

Case study: Closed loop PID control a typical 2 DOF planar robotic manipulator

Case Studies/Assignments: Any of the three case studies can be given as assignments.

Text Books

1. Introduction to Robotics by S K Saha, Mc Graw Hill Education
2. Robert. J. Schilling, “Fundamentals of robotics – Analysis and control”, Prentice Hall of India 1996.
3. R K Mittal and I J Nagrath, “Robotics and Control”, Tata McGraw Hill, New Delhi, 2003.
4. Introduction to Robotics (Mechanics and control), John. J. Craig, Pearson Education Asia 2002.
5. Ashitava Ghosal, “Robotics-Fundamental concepts and analysis”, Oxford University press.
6. Robotics Technology and Flexible Automation, Second Edition, S. R. Deb.
7. Introduction to Robotics, Saeed B. Nikku, Pearson Education, 2001.
8. Rachid Manseur, ‘Robot Modeling and Kinematics’, Lakshmi publications, 2009.

Reference Books

1. D Roy Choudhury and shaail B. jain, ‘Linear Integrated circuits’, New age international Pvt.Ltd 2003
2. Boltans w. ”Mechatronics” Pearson Education , 2009

Course Contents and Lecture Schedule

No	Topic	No. of Lectures
1	Introduction	
1.1	Definitions- Robots, Robotics; Types of Robots- Manipulators, Mobile Robots-wheeled & Legged Robots, Aerial Robots;	1
1.2	Anatomy of a robotic manipulator-links, joints, actuators, sensors, controller; open kinematic vs closed kinematic chain; degrees of freedom;	1
1.3	Robot considerations for an application- number of axes, work volume, capacity & speed, stroke & reach, Repeatability, Precision and Accuracy, Operating environment, point to point control or continuous path control.	1
1.4	Robot Applications- medical, mining, space, defence, security, domestic, entertainment	1
1.5	Industrial Applications-Material handling, welding, Spray painting, Machining.	1

2	Sensors and Actuators	
2.1	Sensor classification- touch, force, proximity, vision sensors	1
2.2	Internal sensors-Position sensors, velocity sensors, acceleration sensors, Force sensors;	1
2.3	External sensors-contact type, non-contact type;	1
2.4	Vision-Elements of vision sensor, image acquisition, image processing; Selection of sensors.	1
2.5	Actuators for robots- classification-Electric, Hydraulic, Pneumatic actuators; their advantages and disadvantages; Electric actuators- Stepper motors, DC motors, DC servo motors and their drivers, AC motors, Linear actuators, selection of motors;	2
2.6	Hydraulic actuators- Components and typical circuit, advantages and disadvantages; Pneumatic Actuators- Components and typical circuit, advantages and disadvantages.	2
3	Robotic configurations and end effectors	
3.1	Robot configurations-PPP, RPP, RRP, RRR; features of SCARA, PUMA Robots	2
3.2	Classification of robots based on motion control methods and drive technologies; 3R concurrent wrist;	2
3.3	Classification of End effectors - mechanical grippers, special tools, Magnetic grippers, Vacuum grippers, adhesive grippers, Active and passive grippers, factors affecting selection of grippers.	3
4	Kinematics and Motion Planning	
4.1	Robot Coordinate Systems- Fundamental and composite rotations, homogeneous coordinates and transformations.	2
4.2	Kinematic parameters, D-H representation, Direct Kinematics. The Arm equation- forward Kinematic analysis of a typical robots up to 3 DOF.	4
4.3	Motion Planning- joint space trajectory planning-cubic polynomial, linear trajectory with parabolic blends; Cartesian space planning, Point to point vs continuous path planning.	2

5	Dynamics and Control of Robots	
5.1	Dynamics- Dynamic model of a robot using Lagrange's equation, dynamic modelling of 1 DOF robot	2
5.2	Control Techniques- Transfer function and state space representation, Performance and stability of feedback control.	3
5.3	PID control of a single link manipulator, selection of PID controller gains; nonlinear nature of manipulators, and need for nonlinear control techniques, Computed torque control.	2

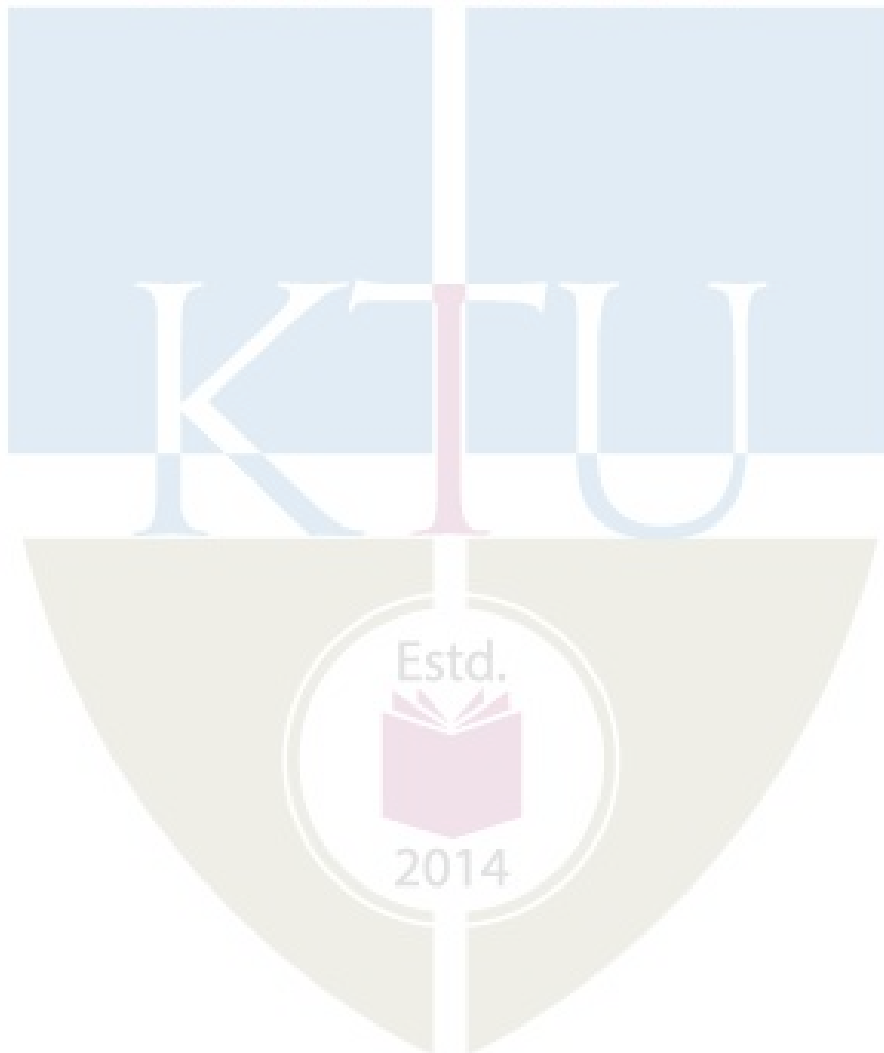

CODE	COURSE NAME	CATEGORY	L	T	P	CREDIT
EET424	ENERGY MANAGEMENT	PEC	2	1	0	3

Preamble: This course introduces basic knowledge about energy management and audit. Energy management opportunities in electrical and mechanical systems are discussed. Demand side management and ancillary services are explained. Economic analysis of energy conservation measures are also described.

Prerequisite: Nil

Course Outcomes: After the completion of the course the student will be able to

CO 1	Analyse the significance of energy management and auditing.
CO 2	Discuss the energy efficiency and management of electrical loads.
CO 3	Apply demand side management techniques.
CO 4	Explain the energy management opportunities in industries.
CO 5	Compute the economic feasibility of the energy conservation measures.

Mapping of course outcomes with program outcomes

	PO 1	PO 2	PO 3	PO 4	PO 5	PO 6	PO7	PO8	PO 9	PO 10	PO 11	PO 12
CO 1	2					1	1		1			
CO 2	2		1	1		1	1					
CO 3	2		1	1		1	1					
CO 4	2		1	1		1	1					
CO 5	2										2	

Assessment Pattern

Bloom's Category	Continuous Assessment Tests		End Semester Examination
	1	2	
Remember (K1)	15	15	30
Understand (K2)	20	20	40
Apply (K3)	15	15	30
Analyse (K4)			
Evaluate (K5)			
Create (K6)			

Mark distribution

Total Marks	CIE	ESE	ESE Duration
150	50	100	3 hours

Continuous Internal Evaluation Pattern:

Attendance : 10 marks

Continuous Assessment Test (2 numbers) : 25 marks

Assignment/Quiz/Course project : 15 marks

End Semester Examination Pattern: There will be two parts; Part A and Part B. Part A contains 10 questions with 2 questions from each module, having 3 marks for each question. Students should answer all questions. Part B contains 2 questions from each module of which student should answer any one. Each question can have a maximum 2 subdivisions and carry 14 marks.

Course Level Assessment Questions**Course Outcome 1 (CO1):**

1. Define energy management. (K1, PO1, PO6, PO7)
2. List the different phases involved in energy management planning. (K1, PO1, PO6, PO7)
3. State the need for energy audit. (K2, PO1, PO6, PO7, PO9)

Course Outcome 2 (CO2)

1. State the different methods which can be adopted to reduce energy consumption in lighting. (K2, PO1, PO3, PO4)
2. Describe how energy consumption can be reduced by energy efficient motors. (K2, PO1, PO3, PO4, PO6, PO7)
3. Discuss the maximum efficiency standards for distribution transformers. (K1, PO1, PO3, PO4, PO6, PO7)

Course Outcome 3 (CO3):

1. Discuss the different techniques of DSM. (K2, PO1, PO3, PO4)
2. Illustrate the different techniques used for peak load management. (K2, PO1, PO3, PO4, PO6, PO7)
3. Explain the different types of ancillary services. (K2, PO1, PO3, PO4)

Course Outcome 4 (CO4):

1. Define Coefficient of performance. (K1, PO1)
2. Demonstrate how waste heat recovery can be done. (K2, PO1, PO3, PO4, PO6, PO7)
3. Describe how energy consumption can be reduced by cogeneration. (K3, PO1, PO3, PO4, PO6, PO7)

Course Outcome 5 (CO5):

1. State the need for economic analysis of energy projects. (K2, PO1, PO11)
2. Define pay back period. (K2, PO1, PO11)
3. Demonstrate how life cycle costing approach can be used for comparing energy projects. (K3, PO1, PO11)

Model Question Paper**QP CODE:**

PAGES: 3

Reg. No: _____

Name: _____

**APJ ABDUL KALAM TECHNOLOGICAL UNIVERSITY EIGHTH SEMESTER
B.TECH DEGREE EXAMINATION,
MONTH & YEAR
Course Code: EET424**

Course Name: ENERGY MANAGEMENT

Max. Marks: 100

Duration: 3 Hours

PART A (3 x 10 = 30 Marks)**Answer all questions. Each question carries 3 Marks**

1. Explain what you mean by power quality audit.
2. Write notes on building management systems.
3. Compare the efficacy of different light sources.
4. Write notes on design measures for increasing efficiency in transformers.
5. Discuss the benefits of demand side management.
6. Explain the benefits of power factor improvement.

7. Discuss any two opportunities for energy savings in steam distribution.
8. Explain the working of a waste heat recovery system.
9. What are the advantages and disadvantages of the payback period method?
10. Write notes on computer aided energy management systems.

PART B (14 x 5 = 70 Marks)

Answer any one full question from each module. Each question carries 14 marks

Module 1

- | | | |
|--------|---|---|
| 11. a. | With the help of case studies, explain any four energy management principles. | 8 |
| | b. Explain the different phases of energy management planning. | 6 |
| 12. a. | Explain the different steps involved in a detailed energy audit. | 7 |
| | b. Discuss the different instruments used for energy audit. | 7 |

Module 2

- | | | |
|--------|---|---|
| 13. a. | With the help of case studies, explain any four methods to reduce energy consumption in lighting. | 8 |
| | b. Explain how energy efficient motors help in reducing energy consumption. | 6 |
| 14. a. | With the help of case studies, explain any four methods to reduce energy consumption in motors. | 8 |
| | b. Define cascade efficiency of an electrical system. How it can be calculated? | 6 |

Module 3

- | | | |
|--------|---|---|
| 15. a. | Explain the different techniques of demand side management. | 6 |
| | b. The load on an installation is 800 kW, 0.8 lagging p.f. which works for 3000 hours per annum. The tariff is Rs 100 per kVA plus 20 paise per kWh. If the power factor is improved to 0.9 lagging by means of loss-free capacitors costing Rs 60 per kVAR, calculate the annual saving effected. Allow 10% per annum for interest and depreciation on capacitors. | 8 |
| 16. a. | Discuss the importance of peak demand control. Explain the different methods used for that. | 8 |

- b. Explain the different types of ancillary services. 6

Module 4

17. a. Explain any four energy conservation opportunities in furnaces 7
 b. Explain the working of different types of cogeneration systems. 7
18. a. Discuss the different energy conservation opportunities in boiler. 7
 b. Explain any five energy saving opportunities in heating, ventilating and air conditioning systems. 7

Module 5

19. a. Calculate the energy saving and payback period which can be achieved by replacing a 11 kW, existing motor with an EEM. The capital investment required for EEM is Rs. 40,000/-. Cost of energy/kWh is Rs. 5. The loading is 70% of the rated value for both motors. Efficiency of the existing motor is 81% and that of EEM is 84.7%. 8
 b. Compare internal rate of return method with present value method for the selection of energy projects. 6
20. a. Explain how the life cycle costing approach can be used for the selection of energy projects. 6
 b. The cash flow of an energy saving project with a capital investment cost of Rs. 20,000/- is given in the table below. Find the NPV of the project at a discount rate of 10%. Also find the Internal Rate of Return of the project. 8

Year	Cash flow
1	7000
2	7000
3	7000
4	7000
5	7000
6	7000

Syllabus

Module 1 (7 hours)

Energy Management - General Principles and Planning:

General principles of energy management and energy management planning

Energy Audit: Definition, need, types and methodologies. Instruments for energy audit, Energy audit report - Power quality audit

Energy conservation in buildings: ECBC code (basic aspects), Building Management System (BMS).

Module 2 (9 hours)

Energy Efficiency in Electricity Utilization:

Electricity transmission and distribution system, cascade efficiency.

Lighting: Modern energy efficient light sources, life and efficacy comparison with older light sources, energy conservation in lighting, use of sensors and lighting automation.

Motors: Development of energy efficient motors and the present status, techniques for improving energy efficiency, necessity for load matching and selection of motors for constant and variable loads.

Transformers: Present maximum efficiency standards for power and distribution transformers, design measures for increasing efficiency in electrical system components.

Module 3 (8 hours)

Demand side Management: Introduction to DSM, benefits of DSM, different techniques of DSM –time of day pricing, multi-utility power exchange model, time of day models for planning. Load management, load priority technique, peak clipping, peak shifting, valley filling, strategic conservation, energy efficient equipment.

Power factor improvement, numerical examples.

DSM and Environment.

Ancillary services: Introduction of ancillary services – Types of Ancillary services

Module 4 (6 hours)

Energy Management in Industries and Commercial Establishments:

Boilers: working principle - blow down, energy conservation opportunities in boiler.

Steam: properties of steam, distribution losses, steam trapping. Identifying opportunities for energy savings in steam distribution.

Furnace: General fuel economy measures, energy conservation opportunities in furnaces.

HVAC system: Performance and saving opportunities in Refrigeration and Air conditioning systems.

Heat Recovery Systems:

Waste heat recovery system - Energy saving opportunities.

Cogeneration: Types and schemes, optimal operation of cogeneration plants, combined cycle electricity generation.

Module 5 (6 hours)**Energy Economics:**

Economic analysis: methods, cash flow model, time value of money, evaluation of proposals, pay-back period, average rate of return method, internal rate of return method, present value method, life cycle costing approach. Computer aided Energy Management Systems (EMS).

Text/Reference Books

1. Energy Conservation Act – 2001 and Related Rules and Standards.
2. Publications of Bureau of Energy Efficiency (BEE).
3. Albert Thumann, William J. Younger, Handbook of Energy Audits, CRC Press, 2003.
4. IEEE recommended practice for energy management in industrial and commercial facilities
5. D. Yogi Goswami, Frank Kreith, Energy Management and Conservation Handbook, CRC Press, 2007
6. Operation of restructured power systems Kankar Bhattacharya, Jaap E. Daadler, Math H.J Bollen, Kluwer Academic Pub., 2001.
7. Wayne C. Turner, Energy management Hand Book - the Fairmount Press, Inc., 1997
8. Charles M. Gottschalk, Industrial energy conservation, John Wiley & Sons, 1996.

No	Topic	No. of Lectures
1	Energy Management - General Principles and Planning; Energy audit (7 hours)	
1.1	Energy management; General principles of energy management	2
1.2	Energy management planning	1
1.3	Energy audit: Definition, need, types and methodologies.	2
1.4	Instruments for energy audit, Energy audit report. Power quality audit	1
1.5	ECBC code (basic aspects), Building Management System (BMS).	1
2	Energy management in Electricity Utilization (8 hours)	
2.1	Electricity transmission and distribution system, cascade efficiency.	1
2.2	Energy management opportunities in Lighting: Modern energy efficient light sources, life and efficacy comparison with older light sources, energy conservation in lighting, use of sensors and lighting automation.	2
2.3	Energy management opportunities in Motors: Development of energy efficient motors and the present status, techniques for improving energy efficiency, necessity for load matching and selection of motors for constant and variable loads.	2
2.4	Transformers: Present maximum efficiency standards for power and distribution transformers, design measures for increasing efficiency in electrical system components.	3
3	Demand side Management and Ancillary service management:(8 hours)	
3.1	Introduction to DSM, benefits of DSM, different techniques of DSM, DSM and Environment.	2
3.2	Time of day pricing, multi-utility power exchange model, time of day models for planning.	2

3.3	Load management, load priority technique, peak clipping, peak shifting, valley filling, strategic conservation, energy efficient equipment.	2
3.4	Power factor improvement, simple problems.	1
3.5	Introduction of ancillary services – Types of Ancillary services	1
4	Energy Management in Industries and Commercial Establishments (6 hours):	
4.1	Boilers: working principle - blow down, energy conservation opportunities in boiler.	1
4.2	Steam: properties of steam, distribution losses, steam trapping. identifying opportunities for energy savings in steam distribution.	1
4.3	Furnace: General fuel economy measures, energy conservation opportunities in furnaces.	1
4.4	Performance and saving opportunities in Refrigeration and Air conditioning systems.	2
4.5	Waste heat recovery system - Energy saving opportunities. Cogeneration: types and schemes, optimal operation of cogeneration plants, combined cycle electricity generation.	1
5	Energy Economics (6 hours)	
5.1	Economic analysis methods	1
5.2	Cash flow model, time value of money, evaluation of proposals	1
5.3	Pay-back method, average rate of return method, internal rate of return method	2
5.4	Present value method, life cycle costing approach.	1
5.4	Computer aided Energy Management Systems (EMS).	1



CODE	COURSE NAME	CATEGORY	L	T	P	CREDIT
EET434	SMART GRID TECHNOLOGIES	PEC	2	1	0	3

Preamble: This course introduces various advancements in the area of smart grid. It also introduces distributed energy resources and micro-grid. In addition, cloud computing, cyber security and power quality issues in smart grids are also introduced.

Prerequisite: Nil

Course Outcomes: After the completion of the course the student will be able to

CO 1	Explain the basic concept of distributed energy resources, micro-grid and smart grid
CO 2	Choose appropriate Information and Communication Technology (ICT) in smart grid
CO 3	Select infrastructure and technologies for consumer domain of smart grid
CO 4	Select infrastructure and technologies for smart substation and distribution automation
CO 5	Formulate cloud computing infrastructure for smart grid considering cyber security
CO 6	Categorize power quality issues and appraise it in smart grid context

Mapping of course outcomes with program outcomes

	PO 1	PO 2	PO 3	PO 4	PO 5	PO 6	PO 7	PO 8	PO 9	PO 10	PO 11	PO 12
CO 1	3	2										
CO 2	3	3	3	3	2							
CO 3	3	3	3	3	2							
CO 4	3	3	3	3								
CO 5	3	3	3	3	3							
CO 6	3	3	3	3	3							

Assessment Pattern

Bloom's Category	Continuous Assessment Tests		End Semester Examination
	1	2	
Remember (K1)	10	10	20
Understand (K2)	30	30	60
Apply (K3)	10	10	20
Analyse (K4)			
Evaluate (K5)			
Create (K6)			

Mark distribution

Total Marks	CIE	ESE	ESE Duration
150	50	100	3 hours

Continuous Internal Evaluation Pattern:

Attendance	: 10 marks
Continuous Assessment Test (2 numbers)	: 25 marks
Assignment/Quiz/Course project	: 15 marks

End Semester Examination Pattern: There will be two parts; Part A and Part B. Part A contain 10 questions with 2 questions from each module, having 3 marks for each question. Students should answer all questions. Part B contains 2 questions from each module of which student should answer any one. Each question can have a maximum of 2 subdivisions and carry 14 marks.

Course Level Assessment Questions**Course Outcome 1 (CO1)**

1. Explain the drivers, functions, opportunities, barriers, challenges, technologies and standards of smart grid (K2, PO1)
2. Explain the basic concept of distributed energy resources and their grid integration. (K2, PO1, PO2)
3. Explain the basic concept of microgrid. (K1, PO1)

Course Outcome 2 (CO2)

1. Choose appropriate communication technology for smart grid. (K3, PO1, PO2, PO3, PO4, PO5)

2. Explain the communication protocols and standards in Smart grid. (K2, PO1)

Course Outcome 3 (CO3)

1. Explain the features and merits of Smart Meters, for smart grid implementation. (K2, PO1, PO2, PO3)
2. Explain the role of real time pricing in smart grid. (K3, PO1, PO2, PO3)
3. Describe the concept and role of AMR and AMI in smart grid. (K2, PO1, PO2)
4. Choose various end use devices and explain their role in Home & Building Automation. (K3, PO1, PO2, PO3, PO4, PO5)
5. Explain the various methods for energy management and role of technology for its implementation. (K3, PO1, PO2, PO3, PO4, PO5)

Course Outcome 4 (CO4)

1. Explain the concept of smart substation. (K1, PO1)
2. Describe the functionalities and applications of IED in substation and distribution automation. (K2, PO1, PO2, PO3, PO4)
3. Explain the architecture components and applications of Wide Area Monitoring Systems. (K3, PO1, PO2, PO3)
4. Explain the role of PMU in WAMS. (K2, PO1, PO2,)
5. Explain the role of various application modules in distribution automation. (K2, PO1, PO2, PO3)

Course Outcome 5 (CO5)

1. Classify cloud computing based on its deployment and services. (K2, PO1)
2. Design cloud architecture of smart grid. (K3, PO1, PO2, PO3, PO4, PO5)
3. Explain the challenges and solutions related to cyber security in smart grid. (K2, PO1, PO2, PO3, PO4, PO5)

Course Outcome 6 (CO6)

1. Explain the power quality issues in smart grid. (K2, PO1, PO2)
2. Choose technologies for the mitigation of power quality issues in the smart grid. (K3, PO1, PO2, PO3, PO4, PO5)

Model Question Paper

QP CODE:

Pages:

Reg No.: _____

Name: _____

APJ ABDUL KALAM TECHNOLOGICAL UNIVERSITY EIGHTH SEMESTER

B.TECH DEGREE EXAMINATION,

MONTH & YEAR

Course code: EET 434**Course Name: SMART GRID TECHNOLOGIES (E)****Max. Marks: 100****Duration: 3hrs****PART A**

(Answer all questions. Each question carries 3 marks)

1. Define smart grid concept and explain its necessity.
2. Explain the concept of resilient and self-healing grid.
3. Write a note on ZIGBEE.
4. Discuss 61850 standard and its benefits.
5. Explain how automatic meter reading can make the system smarter.
6. What is meant by real time pricing?
7. Describe substation automation.
8. Explain outage management system.
9. Explain the necessity of cyber security in smart grid
10. Write a note on power quality conditioners in smart grid.

PART B

11. (a) With the help of block diagram explain the architecture of smart grid (7)
- (b) What are the challenges of smart grid technology? (7)

OR

12. (a) Explain smart grid drivers (6)
- (b) What are the functions of smart grid components (8)

13. (a) Explain the various communication protocols used in smart grid. (7)
(b) Write a note on Wi-Max based communication in smart grid. (7)

OR

14. (a) Write a note on various mobile communication technologies used in smart grid. (7)
(b) Explain the role of HAN in smart grid. (7)
15. (a) Explain plug in electric vehicles (7)
(b) Explain the role of phasor measurement unit in smart grid (7)

OR

16. (a) What are the advantages of smart meters? (5)
(b) What are IEDs? What are their application in monitoring and protection (9)
17. (a) With the help of block diagram explain the main features of smart substation (10)
(b) Explain GIS (4)

OR

18. (a) Explain demand side ancillary services. (7)
(b) Write a note on smart inverters. (7)
19. (a) Describe cloud architecture of smart grid. (7)
(b) Explain the role of EMC in the smart grid. (7)

OR

20. (a) Why is cyber security of prime importance in smart grid and how can it be achieved? (7)
(b) Describe the power quality issues of grid connected renewable energy source (7)

Syllabus

Module 1 Introduction to Smart Grid: Evolution of electric grid, Definitions, Need for smart grid, Smart grid drivers, Functions of smart grid, Opportunities and barriers of smart grid, Difference between conventional grid and smart grid, Concept of resilient and self-healing grid.

Components and architecture, Inter-operability, Impacts of smart grid on system reliability, Present development and international policies in smart grid, Smart grid standards.

Module 2 Information and Communication Technology in Smart Grid: Wired and wireless communication -radio mesh, ZIGBEE, 3G, 4G and 5G. Digital PLC, DSL, Wi-Max, LAN, NAN, HAN, Wi-Fi, Bluetooth, Bluetooth Low Energy (BLE), Li-Fi. Communication Protocols in Smart grid, Introduction to IEC 61850 standard and benefits, IEC Generic Object-Oriented Substation Event - GOOSE, Substation model.

Module 3 Smart grid Technologies Part I: Introduction to smart meters, Electricity tariff, Real Time Pricing- Automatic Meter Reading (AMR) - System, Services and Functions, Components of AMR Systems, Advanced Metering Infrastructure (AMI).

Plug in Hybrid Electric Vehicles (PHEV), Vehicle to Grid (V2G), Grid to Vehicle (G2V), Smart Sensors, Smart energy efficient end use devices, Home & Building Automation.

Intelligent Electronic Devices (IED) and their application for monitoring & protection: Digital Fault Recorder (DFR), Digital Protective Relay (DPR), Circuit Breaker Monitor (CBM), Phasor Measurement Unit (PMU), Standards for PMU. Time synchronization techniques, Wide Area Monitoring System (WAMS), control and protection systems (Architecture, components of WAMS, and applications: Voltage stability assessment, frequency stability assessment, power oscillation assessment, communication needs of WAMS, remedial action scheme).

Module 4 Smart grid Technologies Part II: Smart substations, Substation automation, Feeder automation, Fault detection, Isolation, and Service Restoration (FDIR), Geographic Information System (GIS), Outage Management System (OMS).

Introduction to Smart distributed energy resources and their grid integration, Smart inverters, Concepts of microgrid, Need and application of microgrid – Energy Management- Role of technology in demand response- Demand side management, Demand side Ancillary Services, Dynamic line rating.

Module 5 Cloud computing in smart grid: Private, Public and hybrid cloud. Types of cloud computing services- Software as a Service (SaaS), Platform as a service (PaaS), Infrastructure as a service (IaaS), Data as a service (DaaS), Cloud architecture for smart grid.

Cyber Security - Cyber security challenges and solutions in smart grid, Cyber security risk assessment, Security index computation.

Power Quality Management in Smart Grid- Fundamentals, Power Quality (PQ) & Electromagnetic Compatibility (EMC) in smart grid, Power quality conditioners for smart grid. Case study of smart grid.

Text/Reference Books

1. **Stuart Borlase** “Smart Grid Infrastructure Technology and Solutions”, CRC Press; 2nd edition.
2. **James Momoh**, “Smart Grid: Fundamentals of Design and Analysis”, Wiley, 2012.
3. **S. Chowdhury**, “Microgrids and Active Distribution Networks.” Institution of Engineering and Technology, 2009.
4. **Janaka Ekanayake, Kythira Liyanage, Jianzhong Wu, Akihiko Yokohama, Nick Jenkins-** “Smart Grids Technology and Applications”, Wiley, 2012.
5. **Clark W.Gellings**, “The Smart Grid: Enabling Energy Efficiency and Demand Response”, CRC Press.
6. **Jean Claude Sabonnadière, Nouredine Hadjsaïd**, “Smart Grids”, Wiley Blackwell.
7. **James Larminie, John Lowry**, Electric Vehicle Technology Explained, Wiley, 2003.
8. **Chris Mi, M. AbulMasrur, David WenzhongGao**, “Hybrid Electric Vehicles: Principles and Applications with Practical Perspectives”, 2011, Wiley publication.
9. **Danda B. Rawat; Chandra Bajracharya**, Cyber security for smart grid systems: Status, challenges and perspectives IEEE SoutheastCon 2015, DOI: 10.1109/SECON.2015.7132891.
10. **Pillitteri, V. and Brewer, T. (2014)**, Guidelines for Smart Grid Cybersecurity, NIST Interagency/Internal Report (NISTIR), National Institute of Standards and Technology, Gaithersburg, MD, [online], <https://doi.org/10.6028/NIST.IR.7628r1>.
11. **Barker, Preston, Price, Rudy F.**, “Cybersecurity for the Electric Smart Grid: Elements and Considerations”, Nova Science Publishers Inc, 2012.
12. **Eric D. Knapp, Raj Samani**, “Applied Cyber Security and the Smart Grid: Implementing Security Controls into the Modern Power Infrastructure”, Syngress; 1st edition (26 February 2013).
13. **Richard J. Campbell**, “The Smart Grid and Cybersecurity: Regulatory Policy and Issues”, Congressional Research Service, 2011.
14. **Dariusz Kloza, Vagelis Papakonstantinou, Sanjay Goel, Yuan Hong**, “Smart grid security”, Springer.
15. **Roger C. Dugan**, “Electrical Power Systems Quality”, McGraw-Hill Publication, 3/e.
16. **G.T.Heydt**, “Electric Power Quality”, Stars in a Circle Publications, 2/e.

Course Contents and Lecture Schedule

No	Topic	No. of Lectures
1	Introduction to Smart Grid:	(7)
1.1	Evolution of electric grid, definitions need for smart grid, smart grid drivers, functions of smart grid, opportunities and barriers of smart grid, difference between conventional grid and smart grid, concept of resilient and self- healing grid	3
1.2	Components and architecture, inter-operability, impacts of Smart Grid on system reliability	2
1.3	Present development and international policies in smart grid.	2

	smart grid standards.	
2	Information and Communication Technology in Smart Grid:	(8)
2.1	Wired and wireless communication -radio mesh, ZIGBEE, 3G, 4G and 5G, digital PLC, DSL, Wi-Max, LAN, NAN, HAN, Wi-Fi, bluetooth, Bluetooth Low Energy (BLE), Light-Fi, substation event - GOOSE, IEC 61850 substation model	4
2.2	Communication protocols in smart grid, introduction to IEC 61850 standard and benefits, IEC Generic Object-Oriented Substation Event - GOOSE.	2
2.3	IEC 61850 ,Substation model	2
3	Smart grid Technologies Part I	(7)
3.1	Introduction to smart meters, electricity tariff, real time pricing-Automatic Meter Reading (AMR) System, services and functions, components of AMR systems, Advanced Metering Infrastructure (AMI)	2
3.2	Plug in Hybrid Electric Vehicles (PHEV), Vehicle to Grid, Grid to Vehicle.	1
3.3	Smart sensors, smart energy efficient end use devices, home & building automation, Intelligent Electronic Devices (IED) and their application for monitoring & protection, DFRA, DPRA, CBMA	1
3.4	Phasor Measurement Unit (PMU), standard for PMU. time synchronization techniques, Wide Area Monitoring, control and protection systems - architecture, components of WAMS, and applications: voltage stability assessment, frequency stability assessment, power oscillation assessment, communication needs of WAMS, remedial action scheme.	3
4.	Smart grid Technologies Part II	(7)
4.1	Smart substations, substation automation, feeder automation, fault detection, isolation, and service restoration, Geographic Information System (GIS), Outage Management System (OMS).	2
4.2	Introduction to smart distributed energy resources and their grid integration, smart inverters.	2
4.3	Concepts of micro grid, need & application of micro grid – Energy Management-Role of technology in demand response-Demand Side Management, Demand Side Ancillary Services, Dynamic Line rating.	3
5	Cloud computing in smart grid:	(8)
5.1	Public and hybrid cloud, cloud architecture of smart grid, types of cloud computing services- IaaS, SaaS, PaaS, DaaS.	2
5.2	Cyber Security - Cyber security challenges and solutions in	2

	smart grid, cyber security risk assessment, security index computation .	
5.3	Power Quality Management in Smart Grid- Fundamentals, power quality & EMC in Smart Grid.	2
5.4	Power quality conditioners for smart grid -case study of smart grid	2

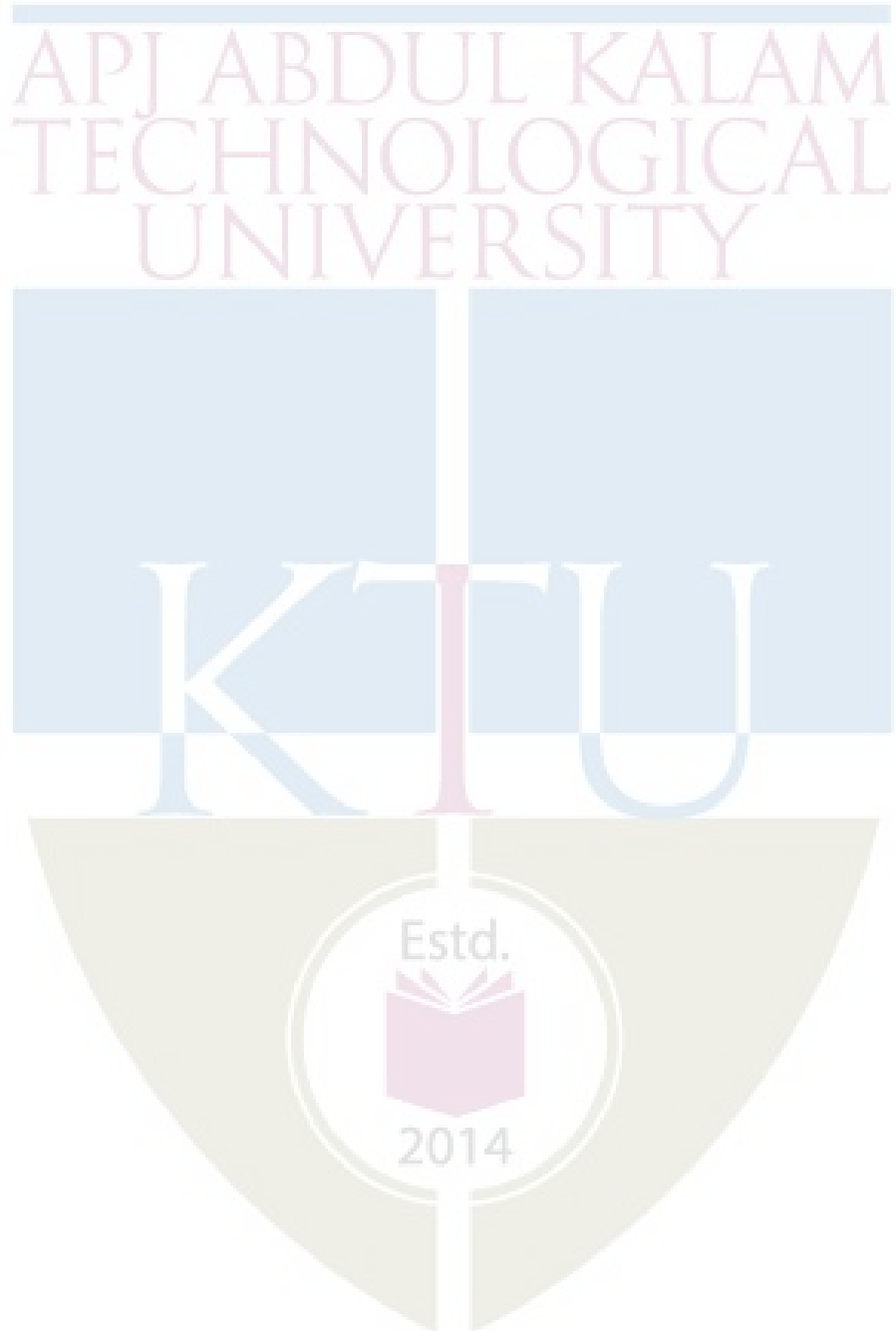

CODE	COURSE NAME	CATEGORY	L	T	P	CREDIT
EET444	ELECTRICAL MACHINE DESIGN	PEC	2	1	0	3

Preamble: This course provides an introduction to the design of DC and AC machines and gives a general idea to the computer aided design of electrical machines.

Prerequisite: 1. EET202 DC Machines and Transformers

2. EET307 Synchronous and Induction Machines

Course Outcomes: After the completion of the course the student will be able to:

CO1	Identify the general design considerations of electrical machines.
CO2	Design armature and field system of DC machines.
CO3	Design core, yoke, windings and cooling systems of transformers.
CO4	Design stator and rotor of induction machines.
CO5	Design stator and rotor of synchronous machines.
CO6	Apply software tools in electrical machine design.

Mapping of course outcomes with program outcomes

	PO1	PO2	PO3	PO4	PO5	PO6	PO7	PO8	PO9	PO10	PO11	PO12
CO1	2	1	-	-	-	-	-	-	-	-	-	-
CO2	3	2	2	-	-	-	-	-	-	-	-	-
CO3	3	2	2	-	-	-	-	-	-	-	-	-
CO4	3	2	2	-	-	-	-	-	-	-	-	-
CO5	3	2	2	-	-	-	-	-	-	-	-	-
CO6	3	2	1	1	1	-	-	-	-	-	-	-

Assessment Pattern

Bloom's Category	Continuous Assessment Tests		End Semester Examination
	1	2	
Remember (K1)	10	10	20
Understand(K2)	10	10	20
Apply (K3)	30	30	60
Analyse (K4)			
Evaluate(K5)			
Create(K6)			

Mark distribution

Total Marks	CIE	ESE	ESE Duration
150	50	100	3 hours

Continuous Internal Evaluation Pattern:

Attendance	: 10 marks
Continuous Assessment Test (2 numbers)	: 25 marks
Assignment/Quiz/Course project	: 15 marks

End Semester Examination Pattern: There will be two parts; Part A and Part B. Part A contain 10 questions with 2 questions from each module, having 3 marks for each question. Students should answer all questions. Part B contains 2 questions from each module of which student should answer any one. Each question can have maximum 2 sub-divisions and carry 14 marks.

Part A: 10 Questions x 3 marks=30 marks; **Part B:** 5 Questions x 14 marks =70 marks.

Course Level Assessment Questions**Course Outcome 1 (CO1)**

1. List five types of enclosures used in electrical machines. (K1,PO2)
2. Explain the various insulation classes and the modern insulating materials. (K1,PO1)
3. Problems based on temperature rise calculations. (K2,PO2)

Course Outcome 2 (CO2)

1. Derive the output equation of a DC machine. (K2, PO1)
2. Discuss the factors that influence the choice of number of poles in a DC machine. (K1,PO2)
3. Problems based on the design of main dimensions and armature of a DC machine. (K3,PO3)
4. Problems based on the design of field system of a DC machine. (K3,PO3)

Course Outcome 3 (CO3)

1. Define window space factor in transformer design. (K1,PO2)
2. Derive output equation of transformers. (K2,PO1)
3. Problems based on the dimensions of transformers. (K3,PO3)

Course Outcome 4 (CO4)

1. Derive the expression for end ring current of a squirrel cage induction motor. (K2,PO1)
2. Write a short note on selection of current density in an induction motor in consideration to the insulation system. (K2,PO2)
3. Problems based on the design of an induction motor. (K3,PO3)

Course Outcome 5 (CO5)

1. Briefly explain the factors affecting the choice of specific electric and magnetic loadings in a synchronous machine. (K2,PO2)

2. Problems based on the design of synchronous machines. (K3,PO3)
3. Briefly explain the features of a brushless alternator. (K1,PO1)

Course Outcome 6 (CO6)

1. Explain how the finite element method is used for the analysis of electrical machines. (K2,PO1)
2. Explain various methods for the computer aided design of electrical machines. (K1,PO2)
3. Explain the analysis method with flow chart for computer aided design of electrical machines. (K1,PO2)

*Note: Design, simulation and optimization using electromagnetic field simulation software can be achieved **through assignments**. (PO3, PO4 and PO5)*

Model Question Paper

QP CODE:

PAGES: 3

Reg. No: _____

Name : _____

**APJ ABDUL KALAM TECHNOLOGICAL UNIVERSITY
EIGHTH SEMESTER B.TECH DEGREE EXAMINATION,
MONTH & YEAR
Course Code: EET444
Course Name: ELECTRICAL MACHINE DESIGN**

Max. Marks: 100

Duration: 3 Hours

PART A (3 x 10 = 30 Marks)

Answer all questions. Each question carries 3 marks

1. List any four types of enclosures used in electrical machines.
2. Derive the gap contraction factor for slots.
3. Derive the output equation of a DC machine.
4. Explain the importance of proper pole proportions while separating the values of D and L in a DC machine.
5. Derive the output equation of a single phase transformer.
6. Briefly explain the cast resin transformer.
7. Discuss the choice of specific magnetic loading and specific electric loading in induction machines.
8. Derive the expression for end ring current in a squirrel cage induction motor.
9. Explain the synthesis method for computer aided design with a flow chart.
10. Briefly explain the features of a brushless alternator.

PART B (14 x 5 = 70 Marks)

Answer any one full question from each module. Each question carries 14 marks.

Module 1

11. a) Discuss the thermal and dielectric properties of the following insulating materials used in electrical machines. i) Nomex and ii) Polyamide films. (4 marks)
- b) The temperature rise of a transformer is 25°C after one hour and 37.5°C after 2 hours starting from cold conditions. Calculate its final steady temperature rise and the heating time constant. If its temperature falls from the final steady value to 40°C in 2.5 hours when disconnected, calculate its cooling time constant. The ambient temperature is 30°C . (10 marks)
12. a) What is Carter's coefficient and how does it help in the estimation of mmf of a machine with slotted armature? (6 marks)
- b) Derive the expression for the temperature rise in a machine. Is heating time constant greater than cooling time constant? Justify your answer. (8 marks)

Module 2

13. a) Discuss the factors that influence the choice of number of poles in DC machines. (4 marks)
- b) Find out the main dimensions of a 50kW, 4 pole, 600rpm DC shunt generator to give a square pole face. The full load terminal voltage being 220 V. The maximum gap density is 0.83Wb/m^2 and the ampere conductors per meter is 30000. Assume that full load armature voltage drop is 3 percent of rated terminal voltage and that the field current is 1 percent of rated full load current. Ratio of pole arc to pole pitch is 0.67. (10 marks)
14. a) Explain the design procedure of brushes and commutators for a DC machine. (4 marks)
- b) The following particulars refer to the shunt field coil for a 440V, 6pole, DC generator: mmf per pole = 7000A; depth of winding = 50mm; length of inner turn = 1.1m; length of outer turn = 1.4m; loss radiated from outer surface excluding ends = 1400 W/m^2 ; space factor = 0.62; resistivity = $0.02\ \Omega/\text{m}$ and mm^2 . Calculate a) the diameter of wire b) length of coil c) no. of turns and d) exciting current. Assume a voltage drop of 20% of terminal voltage across the field regulator. (10 marks)

Module 3

15. a) Compare distribution and power transformers. (4 marks)
- b) Determine the dimensions of core and window of a 5kVA, 50 Hz, single phase core type transformer. A rectangular core is used with long side twice as long as short side. The window height is 3 times the width. Voltage per turn is 1.8 V, space factor is 0.2, current density is 1.8A/mm^2 and flux density is 1Wb/m^2 . (10 marks)

16. a) Define window space factor in transformer design. (4 marks)
 b) A 300kVA, 11000/400V, 3 phase, core type transformer has a total loss of 5000W at full load. The transformer tank is 1.25m in height and 1m x 0.75 m in plan. Design a suitable design for tubes if average temperature rise is to be limited to 360C. The diameter of the tube is 50mm and is placed 75mm apart. Average height of tubes is 1.05m, specific heat dissipation due to radiation = $6\text{W/m}^2 \text{ }^\circ\text{C}$ and specific heat dissipation due to convection = $6.5\text{W/m}^2 \text{ }^\circ\text{C}$. Assume that convection is improved by 35 percent due to provision of tubes. (10 marks)

Module 4

17. Find the main dimensions, number of radial ducts, number of stator slots and number of turns per phase of a 3.7kW, 4 pole, 50 Hz, squirrel cage induction motor to be started by star-delta starter. Work out the winding details. The average flux density in the air gap = 0.45 T, ampere conductors per meter = 23000, efficiency = 0.85, power factor = 0.84. Choose main dimensions to achieve cheap design. Winding factor = 0.955, Iron stacking factor = 0.9. (14 marks)
18. a) What is cogging in an induction motor? (4 marks)
 b) Determine approximate values for the stator bore and the effective core length of a 55kW, 415V, 3-phase, star connected, 50Hz, four pole induction motor, Efficiency = 90%, power factor= 0.91, winding factor = 0.955, Assume suitable data wherever necessary with proper justification. (10 marks)

Module 5

19. a) What is short circuit ratio? How does the value of SCR affect the design of a synchronous generator? (4 marks)
 b) Determine the main dimensions of a 2500 kVA, 187.5rpm, 50Hz, 3 phase, 3 kV, salient pole alternator. The generator is to be a vertical, water wheel type. The specific magnetic loading is 0.6Wb/m^2 and the specific electric loading is 34000A/m. Use circular poles with ratio of core length to pole pitch= 0.65. Specify the type of pole construction used if the run-away speed is about 2 times the normal speed. (10 marks)
20. a) Explain the design procedure for a synchronous generator using finite element software technique. (4 marks)
 b) Determine the diameter, core length, size, no. of conductors and no. of slots for stator of a 15MVA, 11kV, 50Hz, 2 pole, star connected turbo-alternator with 60° phase spread. Assume specific magnetic loading = 0.55 Tesla, specific electric loading = 36,000, current density = 5A/mm^2 , peripheral speed = 160m/s. The winding should be arranged to eliminate 5th harmonic. (10 marks)

Syllabus

Module 1 (7 hours)

Principles of electrical machine design: General design considerations, types of enclosures - types of ventilation. Heating - cooling and temperature rise calculation – numerical problems. Continuous, short time and intermittent ratings. Insulation classes – Introduction to modern insulating materials, such as Nomex, Polyamide films and Silicone. Types of cooling in transformers and rotating electrical machines.

Magnetic system - Carter's coefficient – real and apparent flux density. Unbalanced magnetic pull and its practical aspects.

Module 2 (7 hours)

DC Machines: Output equation - main dimensions - choice of specific electric and magnetic loadings corresponding to the insulating materials, magnetic material and type of cooling considered - choice of speed and number of poles - design of armature conductors, slots and winding - design problems. Design of air-gap - design of field system – design problems. Fundamental design aspects of interpoles, compensating winding, commutator and brushes.

Module 3 (7 hours)

Transformers: Design of transformers - single phase and three phase transformers - distribution and power transformers - output equation - core design with due consideration to percentage impedance required - window area - window space factor - overall dimensions of core – design problems. Windings - no. of turns - current density in consideration to the insulation scheme - conductor section. Design of cooling tank with tubes – design problems. Essential design features of cast resin dry type transformers. Fundamentals of K-factor rated transformer, ECBC standards for transformers, BEE Star rating of transformers.

Module 4 (7 hours)

Induction machines: Output equation - main dimensions - choice of specific electric and magnetic loadings corresponding to the insulating materials, magnetic material and type of cooling considered - design of stator and rotor windings - round conductor or rectangular conductor - design of stator and rotor slots, air-gap of slip ring and squirrel cage motors - calculation of rotor bar and end ring currents in cage rotor - design of slip ring rotor winding - design problems. Design aspects of induction motor for drive applications (basic principles only).

Module 5 (8 hours)

Synchronous Machines: Output equation - salient pole and turbo alternators - main dimensions - choice of specific electric and magnetic loadings corresponding to the insulating materials, magnetic material and type of cooling considered - significance of short circuit ratio - choice of speed and number of poles - design of armature conductors, slots and winding - round conductor or rectangular conductor - design of air-gap - design problems.

Fundamental design aspects of the field system and damper winding. Features of brushless alternators.

Introduction to computer aided design: Analysis and synthesis methods - hybrid techniques. Introduction to machine design softwares using Finite Element Method.

Design, simulation and optimization using electromagnetic field simulation software (Assignment only).

Text Books

1. Sawhney A K, A Course in Electrical Machine Design, Dhanpat Rai & Co., 2016.
2. Say M G, The Performance and Design of AC Machines, CBS Publishers, New Delhi, 3rd edition, 2002.
3. Clayton A E & Hancock N N, Performance and Design of DC Machines, ELBS, 1971.

References

1. IS 1180 (Part 1):2014, Bureau of Indian Standards. <https://bis.gov.in>
2. S.O. No. 4062 (E) for Distribution Transformer dated 16th December, 2016, Bureau of Energy Efficiency, Govt. of India, Ministry of Power. <https://www.beestarlabel.com>
3. M. V. Deshpande, "Design and Testing of Electrical Machines", Wheeler Publishing.
4. R. K. Agarwal, "Principles of Electrical Machine Design", Essakay Publications, Delhi.
5. Ramamoorthy M, "Computer Aided Design of Electrical Equipment", East-West Press.
6. M. N. O. Sadiku, "Numerical techniques in Electromagnetics", CRC Press Edition-2001.

Course Contents and Lecture Schedule

No.	Topic	No. of Lectures
1	Principles of electrical machine design (7 hours)	
1.1	General design considerations, types of enclosures - types of ventilation.	1
1.2	Heating - cooling and temperature rise calculation – numerical problems.	1
1.3	Continuous, short time and intermittent ratings.	1
1.4	Insulation classes – Introduction to modern insulating materials,	1

	such as Nomex, Polyamide films and Silicone.	
1.5	Types of cooling in transformers and rotating electrical machines.	1
1.6	Magnetic system - Carter's coefficient – real and apparent flux density.	1
1.7	Unbalanced magnetic pull and its practical aspects.	1
2	Design of DC Machines (7 hours)	
2.1	Output equation - main dimensions	1
2.2	Choice of specific electric and magnetic loadings corresponding to the insulating materials, magnetic material and type of cooling considered	1
2.3	Choice of speed and number of poles	1
2.4	Design of armature conductors, slots and winding	1
2.5	Design problems and design of air-gap	1
2.6	Design of field system – design problems.	1
2.7	Fundamental design aspects of interpoles, compensating winding, commutator and brushes	1
3	Design of Transformers (7 hours)	
3.1	Single phase and three phase transformers - distribution and power transformers - output equation	1
3.2	Core design with due consideration to percentage impedance required	1
3.3	Window area - window space factor - overall dimensions of core – design problems.	1
3.4	Windings - no. of turns - current density in consideration to the insulation scheme - conductor section.	1
3.5	Design of cooling tank with tubes – design problems.	1
3.6	Essential design features of cast resin dry type transformers.	1
3.7	Fundamentals of K-factor rated transformer, ECBC standards for transformers, BEE Star rating of transformers.	1
4	Design of Induction machines (7 hours)	
4.1	Output equation - main dimensions	1
4.2	Choice of specific electric and magnetic loadings corresponding to the insulating materials, magnetic material and type of cooling considered	1
4.3	Design of stator and rotor windings - round conductor or rectangular conductor	1
4.4	Design of stator and rotor slots, air-gap of slip ring and squirrel cage motors - calculation of rotor bar and end ring currents in cage rotor	1
4.5	Design of slip ring rotor winding	1
4.6	Design problems	1
4.7	Design aspects of induction motor for drive applications (basic principles only).	1

5	Design of Synchronous Machines and Introduction to computer aided design (8 hours)	
5.1	Output equation - salient pole and turbo alternators - main dimensions	1
5.2	Choice of specific electric and magnetic loadings corresponding to the insulating materials, magnetic material and type of cooling considered	1
5.3	Significance of short circuit ratio - choice of speed and number of poles	1
5.4	Design of armature conductors, slots and winding - round conductor or rectangular conductor - design of air-gap	1
5.5	Design problems	1
5.6	Fundamental design aspects of field system and damper winding. Features of brushless alternators.	1
5.7	Analysis and synthesis methods - hybrid techniques.	1
5.8	Introduction to machine design softwares using Finite Element Method. Design, simulation and optimization using electromagnetic field simulation software (Assignment only).	1

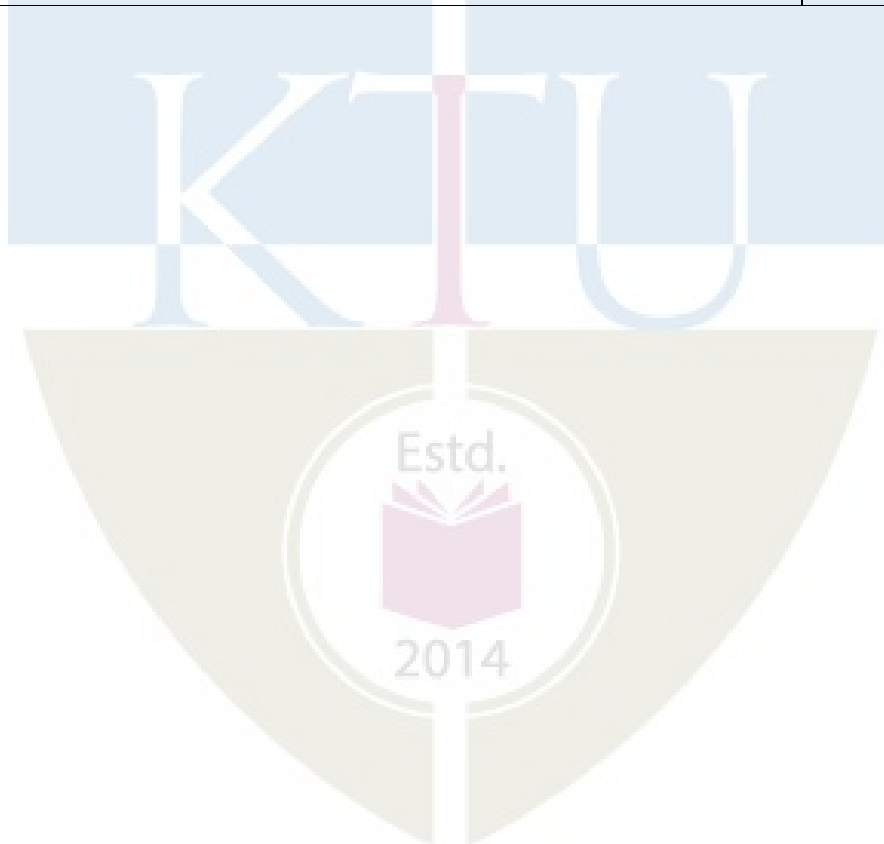

CODE	COURSE NAME	CATEGORY	L	T	P	CREDIT
EET454	SWITCHED MODE POWER CONVERTERS	PEC	2	1	0	3

Preamble: This course builds upon the course EET 306: Power Electronics, to give the students a detailed exposure to switched-mode power converter analysis and design. The objectives of this course are:

1. To give a comprehensive exposure to the power converter topologies widely used in the industry for power supply applications.
2. To equip the students with necessary theoretical knowledge to develop practical power converter designs.

Prerequisite: EET306 POWER ELECTRONICS

Course Outcomes: After the completion of the course the student will be able to

CO 1	Develop the basic design for non-isolated DC-DC converter topologies.
CO 2	Analyse isolated DC-DC converter topologies.
CO 3	Describe the operation of Switched mode inverters and rectifiers.
CO 4	Distinguish between inverter modulation strategies.
CO 5	Describe the operation of Soft switching resonant converters.

Mapping of course outcomes with program outcomes

	PO 1	PO 2	PO 3	PO 4	PO 5	PO 6	PO 7	PO 8	PO 9	PO 10	PO 11	PO 12
CO 1	3	2	1	1								2
CO 2	3	2	1	1								2
CO 3	3	1	1									2
CO 4	3	1	1									2
CO 5	3	1	1									2

Assessment Pattern

Bloom's Category	Continuous Assessment Tests		End Semester Examination
	1	2	
Remember	10	10	20
Understand	10	10	50
Apply	20	20	30
Analyse	10	10	
Evaluate			
Create			

Mark distribution

Total Marks	CIE	ESE	ESE Duration
150	50	100	3 hours

Continuous Internal Evaluation Pattern:

Attendance	: 10 marks
Continuous Assessment Test (2 numbers)	: 25 marks
Assignment/Quiz/Course project	: 15 marks

End Semester Examination Pattern: There will be two parts; Part A and Part B. Part A contain 10 questions with 2 questions from each module, having 3 marks for each question. Students should answer all questions. Part B contains 2 questions from each module of which student should answer any one. Each question can have maximum 2 sub-divisions and carry 14 marks.

Course Level Assessment Questions**Course Outcome 1 (CO1):**

1. Design the power circuits of basic dc-dc converters (K2, K3 and K4 level, PO1, PO2, PO3, PO4)
2. Analyse and determine the mode of operation of the given circuit. (K2, K3, K4, PO1, PO2)
3. Design dc-dc non-isolated converters to operate under given conditions/specifications. (K2, K3, K4, PO1, PO2, PO3, PO4)
4. What is the primary difference between switched mode power conversion and linear power conversion? (K1, PO1)

Course Outcome 2 (CO2)

1. Analyse circuits of isolated dc-dc topologies. give relevant waveforms. (K2, K3, K4 levels, PO1, PO2).
2. Explain unidirectional and bidirectional magnetic core excitation.(K1, PO1)
3. Explain double ended forward converter with neat diagram. (K1, PO1)
4. Describe the operation of the push-pull dc-dc converter. Also derive the expression of output voltage. (K1, PO1, PO2)

Course Outcome 3(CO3):

1. Describe the operation of three-phase/single-phase rectifiers (K2, K3, PO1)

2. Explain active wave shaping of input line current through PFC boost converter. (K1, PO1)
3. With a neat circuit diagram, explain the working of the switched mode rectifier. (K1, PO1)
4. Find the Switch utilization factor for single phase full bridge dc-dc converter.(K1, PO1, PO2)

Course Outcome 4 (CO4):

1. Compare PWM schemes and select an appropriate method for given application (K2, K3, K4, PO1)
2. Explain switching times and space vector sequence of space vector modulation. (K1, PO1)
3. With waveform explain hysteresis current control . (K1, PO1)
4. With waveform explain programmed harmonic elimination of single phase inverter. (K1, PO1)

Course Outcome 5 (CO5):

1. Distinguish between hard-switching and soft-switching methods. (K2, PO1)
2. Explain with a neat diagram, series resonant and parallel resonant circuit . Also draw the frequency characteristics . (K1, PO1)
3. Explain significance of Zero voltage and Zero current switching in dc –dc converters. (K1, PO1)
4. Illustrate how switching losses are reduced in ZVS configuration. (K1, PO1, PO2)

Estd.



2014

Model Question Paper**QP CODE:****Pages:****Reg No.:** _____**Name:** _____**APJ ABDUL KALAM TECHNOLOGICAL UNIVERSITY EIGHTH SEMESTER****B.TECH DEGREE EXAMINATION,
MONTH & YEAR****Course Code: EET454****Course Name: SWITCHED MODE POWER CONVERTERS****Max. Marks: 100****Duration: 3 hours****PART A****Answer all questions; each question carries 3 marks.**

1. What is the primary difference between switched mode power conversion linear power conversion?
2. Draw the circuit diagram of a dc-dc converter that, when operated in continuous conduction mode yields continuous currents in both input and output terminals, and inverted output voltage.
3. Draw the circuit diagram of a two-switch flyback converter and explain why it cannot operate with duty ratios beyond 50%.
4. What are the advantages of a current-fed isolated dc-dc converter?
5. In a single-phase full-bridge PWM inverter operating with Sine PWM and in linear modulation range, what would be the maximum possible rms value of the fundamental voltage that can be obtained at the output if the dc voltage is fixed at 500V?
6. Draw the circuit diagram of the single-phase boost power factor correction rectifier topology. Which signals need to be sensed in order to control this converter?

7. How many space vectors can be produced by a three-phase bridge inverter? Represent them in a table in the given format below:

Sl. No.	Switch states	Space vector magnitude	Location (angle)

8. Differentiate between current controlled voltage source inverter and hysteresis current controlled inverter.
9. Differentiate between PWM hard-switching and Soft-switching.
10. Draw the ZCS switch configuration and explain how the position of the resonant components aid in zero-current switching.

PART B

Answer any one complete question from each section; each question carries 14 mark

- 11 (a) Derive an expression for the peak-to-peak current ripple in the inductor in a buck converter operating in continuous conduction mode, in terms of the output voltage, operating duty ratio and the value of the inductor. Draw the relevant waveforms used in the derivation. (4)
- (b) A photovoltaic panel is rated for an output voltage range between 15 V to 18 V, 36 W peak output power. This panel is to be connected to a dc load that demands a fixed dc voltage of 12 V, with ripple less than 1% of the rated output voltage. Assume the converter is to be operated in discontinuous conduction mode when the load is less than 50% of the rated output power. Select a converter topology suitable for this application, and design it to meet the given specifications. Evaluate the duty ratio D when the input voltage is 18 V and the load is 30% of the rated output power, (10) with the component values selected for the design.

OR

- 12 (a) A Ćuk converter is supplied with an input voltage that varies between 5V and 10V. The output is required to be regulated at 15V. Find the duty ratio range. Assume the converter is working with continuous conduction mode for the entire range. If the load power is 50W, evaluate the input currents for the minimum and maximum input voltages, assuming an (5) ideal converter.

- (b) Develop the voltage transfer ratio of a buck converter operating in Discontinuous Conduction Mode. (9)

- 13 (a) Compare the features of single-switch and two-switch flyback converter topologies. (4)

- (b) It is required to design a power converter with the following features:
 (i). Electrical isolation is required.
 (ii). Gate drives should be referenced to the same electrical potential.
 (iii). The input voltage is 200 V, and the output voltage is 12 V; Power is 250 W.
 A junior technician came up with the options: Two-switch Flyback converter, Two-switch forward converter, Push-pull converter, Full-bridge isolated converter and Half-bridge isolated converter. As a design engineer, which out of these options will you choose that can meet the requirements? Develop a basic design of the inductor and capacitor, by assuming a current ripple of 20% of output current and 1% of nominal output voltage as voltage ripple. Evaluate the duty ratio and choose an appropriate turns ratio for the transformer. (10)

OR

- 14 (a) A flyback converter with 15V input voltage is operating with a duty ratio of 0.4. If the turns ratio of the coupled inductor is 1:0.5, evaluate the output voltage. Assume continuous conduction mode. What is the peak voltage appearing across the switch? Draw the waveforms of the input current, output diode current and voltage across the switch under the given operating conditions and mark the salient features. (6)

- (b) For a forward converter with $V_d=48V\pm 10\%$; $V_o= 5V$ (regulated); $f_s=100kHz$; $P_{load}=15-50W$. If the flux reset winding $N_3=N_1$, calculate the turns ratio N_2/N_1 if this turns ratio is desired to be as small as possible. (8)

- 15 (a) What are the dominant harmonics in the output line-to-line voltage of a three-phase bridge inverter operating in square-wave mode? Show the line voltage waveform and the harmonic spectrum upto the first 7 dominant harmonics (not upto the 7th). (5)

- (b) Describe a single-phase power factor corrected rectification scheme utilising boost converter and its control. Explain how the input current is actively shaped for reduced THD. (9)

OR

- 16 (a) In a single phase full bridge sine PWM inverter, the input dc voltage varies in a range of 295-325 V. Because of the low distortion required in the output, the inverter is operated in the linear modulation range. What is the highest output fundamental rms voltage that can be obtained from this inverter? If the inverter is to be rated at 2 kVA, calculate the combined switch utilisation ratio of the inverter when it is supplying rated VA. (6)
Assume the load current is sinusoidal.
- (b) Explain how a single-phase full-bridge topology can be used as a utility interfaced high-power factor rectifier. (8)
- 17 (a) For a Space Vector PWM based inverter, the dc voltage is 600 V. The switching frequency is 20 kHz. The reference voltage vector is $200\angle 30^\circ$ Vrms, at a particular sampling interval.
- (i). Identify the active vectors to be used during the given sampling interval. Indicate the corresponding switch states.
- (ii). The dwell-times of the active vectors and the zero vector during the interval.
- (iii). Evaluate the dwell times when the reference vector is at 180° out-of phase with the original location. (8)
- (b) What is Selective Harmonic Elimination? Explain with respect to a single-phase inverter. (6)

OR

- 18 (a) Explain the working of a current controlled voltage source inverter with fixed switching frequency. (6)
- (b) Explain how the number of switchings per sampling period are minimised by proper sequencing of the active and zero vectors in Space Vector Modulation. (8)
- 19 (a) Differentiate between ZCS and ZVS topologies. What are the parasitic elements which are usefully employed in these topologies? (6)
- (b) With circuit diagram and relevant waveforms, describe the operation of a series loaded resonant converter operating in discontinuous conduction mode. (8)

OR

- 20 (a) The ZCS and ZVS resonant switches are dual implementations. Explain (6)
why.
- (b) Which of the load resonant converters is a voltage-boosting converter?
Explain with relevant diagrams/graphs. (8)

Syllabus

Module 1

Switched Mode non-isolated DC-to-DC Converters:

Linear Vs Switching Power Electronics.

Buck, Boost, Buck-boost and Ćuk converters: Principles of steady-state analysis - Inductor volt-seconds balance and capacitor amp-seconds balance – Operation in Continuous Conduction Mode (CCM)- Voltage Gain – design of filter inductance & capacitance - boundary between continuous and discontinuous conduction – critical values of inductance/load resistance - Examples for buck and boost converters.

Discontinuous Conduction Mode (DCM) of buck converter with constant output voltage – Output voltage ripple in DCM. Voltage Gain in DCM for buck converters.

Module 2

DC-DC converters with electrical isolation:

High-frequency transformers for DC-DC converters: unidirectional magnetic core excitation & bidirectional core excitation.

Fly back converter: Operation and waveforms in continuous & discontinuous conduction modes – Voltage gain.

CCM operation of double ended fly-back converter.

Forward converter in CCM: Basic forward converter with ideal transformer – practical forward converter with core reset – double ended forward converter

Push-Pull, Half-Bridge and Full-Bridge converters: Operation in Continuous Conduction Mode (CCM) – Flux-walking in isolated converters.

Current-source DC-DC converter.

Module 3

Switched Mode DC to AC converters:

Review of single-phase bridge inverters - 3-phase Sine-PWM inverter: – Linear Modulation, RMS fundamental line to line voltage & RMS fundamental line-to-line voltage – Overmodulation - Square wave operation in three-phase inverters - Switch utilisation ratio of 1-phase & 3-phase full-bridge inverters.

PWM Rectifiers: Generation of current harmonics in diode bridge rectifiers - Power factor - Improved single-phase utility interface - Active shaping of input line current through PFC boost converter - Single phase Switched mode rectifier.

Module 4

Modulation Schemes:

Space Vector Modulation: Concept of space vector – space vector modulation – reference vector & switching (dwell) times – space vector sequence – comparison of sine PWM & space vector PWM.

Programmed (selective) harmonic elimination switching in single phase inverters (Formulation example with elimination of two harmonics at a time) – current controlled voltage source inverter -

Hysteresis current control.

Module 5

Softswitching and resonant converters:

Hard-switched Vs Soft-switched converters -

Resonant Converters - Basic resonant circuit concepts – series resonant circuit – parallel resonant circuit – series-loaded and parallel loaded resonant converters (Operation in discontinuous conduction mode with $\omega_s < 0.5 \omega_r$).

Resonant Switch (Quasi-resonant) Converters: ZCS buck converter - L type - ZVS buck converter – comparison of ZCS & ZVS Resonant Converters.

Note: Assignments may be given to develop simulations of the converter topologies in open-loop and/or closed-loop using appropriate simulation tools. Assignments may also be given to develop design automation scripts/tools using Python, MATLAB, C, Spreadsheets etc.

Text Books

1. Ned Mohan, Tore M. Undeland and William P. Robbins, “Power Electronics: Converters, Applications and Design,” Third Edition, John Wiley and Sons, 2003.

Reference Books

1. Joseph Vithayathil, “Power Electronics: Principles and Applications,” Tata McGrawhill edition.
2. Robert W. Erickson and Dragan Maksimovic, “Fundamentals of Power Electronics,” Second Edition, Springer International Edition (Indian reprint).
3. L. Umanand, “Power Electronics: Elements and Applications,” Wiley India, 2009.

Course Contents and Lecture Schedule

No	Topic	No. of Lectures
1	Non-isolated DC-DC converters:	7 Hours
1.1	Introduction: Linear Vs Switching Power Electronics. Buck and Boost Converters: Topology, principles of low-ripple approximation and inductor volt-sec/capacitor amp-sec balance., Application in developing the voltage transformation ratio in CCM. Evaluation of Inductances and Capacitance for specified current/voltage ripple.	2
1.2	Buck-boost and Cuk Converters: Topology, Application of inductor volt-sec balance/Capacitor amp-sec balance in developing the voltage transformation ratio in CCM. Evaluation of Inductances and Capacitor for specified current/voltage ripple.	2
1.3	Boundary between continuous and discontinuous conduction modes– critical values of inductance/load resistance - Examples for buck and boost converters.	1
1.4	Discontinuous Conduction Mode (DCM) of buck converter with constant output voltage – Output voltage ripple in DCM. Voltage Gain in DCM for buck converters.	2
2	DC-DC converters with electrical isolation:	8 Hours
2.1	High-frequency transformers for DC-DC converters: unidirectional magnetic core excitation & bidirectional core excitation.	1
2.2	Fly back converter: Operation and waveforms in continuous & discontinuous conduction modes – Voltage gain; CCM operation of double ended fly-back converter.	2

2.3	Forward converter in CCM: Basic forward converter with ideal transformer – practical forward converter with core reset – double ended forward converter.	2
2.4	Push-Pull, Half-Bridge and Full-Bridge converters: Operation in Continuous Conduction Mode (CCM) – Flux-walking in isolated converters.	2
2.5	Current-source DC-DC converter	1
3	Switched Mode Inverters and Rectifiers	6 hours
3.1	Review of single-phase bridge inverters - 3-phase voltage source inverter: 3-phase Sine-PWM inverter – RMS line to line voltage & RMS fundamental line-to-line voltage – square wave operation - Switch utilisation ratio of 1-phase & 3-phase full-bridge inverters.	2
3.2	PWM Rectifiers: (Ch. 8 of Ref. 1): Generation of current harmonics in diode bridge rectifiers - Power factor - Improved single-phase utility interface - Active shaping of input line current through PFC boost converter -Single phase Switched mode rectifier operation and control.	4
4	Modulation Schemes:	7 Hours
4.1	Concept of space vector; Origin of flux space phasor representation.	1
4.2	Space vector modulation – reference vector & switching times – space vector sequence	2
4.3	Comparison of sine PWM & space vector PWM.	1
4.4	Programmed (selective) harmonic elimination switching in single phase inverters (example with elimination of third and fifth harmonics)	2
4.5	Current controlled voltage source inverter - Hysteresis current control.	1
5	Softswitching and Resonant Converters:	8 hours
5.1	Softswitching and resonant converters: Hard-switched Vs Soft-switched converters - Switching losses and transition of voltage and current during switching in Hard Switched converters.	1
5.2	Resonant Converters - Basic resonant circuit concepts – series resonant circuit – parallel resonant circuit	2

5.3	Series-loaded (Operation in discontinuous conduction mode with $\omega_{sw} < 0.5 \omega_r$; ω_{sw} : Switching frequency and ω_r : Resonant frequency)	1
5.4	Parallel loaded resonant converters (Operation in discontinuous conduction mode with $\omega_{sw} < 0.5 \omega_r$; ω_{sw} : Switching frequency and ω_r : Resonant frequency).	1
5.5	Resonant Switch (Quasi-resonant) Converters: ZCS buck converter - L type.	2
5.6	ZVS buck converter – Comparison of ZCS & ZVS Resonant Converters.	1

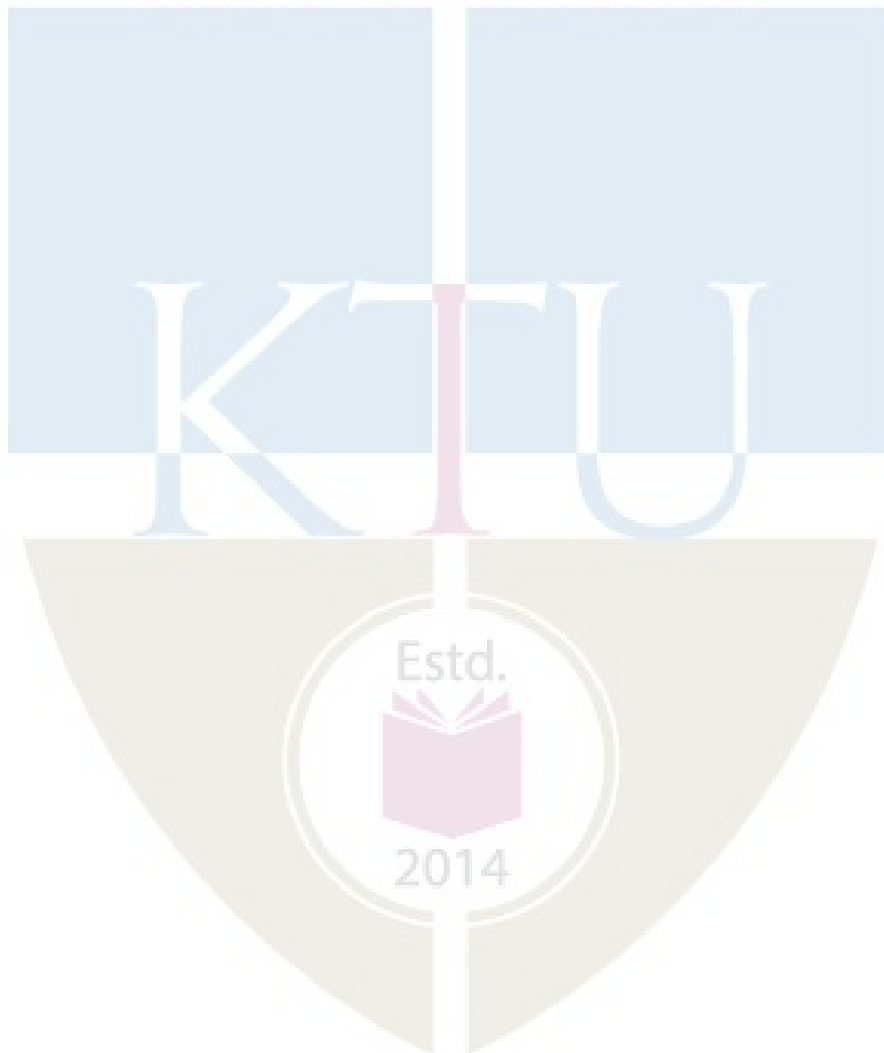

CODE	COURSE NAME	CATEGORY	L	T	P	CREDIT
EET464	COMPUTER AIDED POWER SYSTEM ANALYSIS	PEC	2	1	0	3

Preamble: The basic objective of this course is to familiarize the efficient computational techniques applied in analyzing the power system.

Prerequisite: Circuits and Networks, Power Systems I, Power Systems II

Course Outcomes: After the completion of the course the student will be able to

CO1	Develop the model of power system networks
CO2	Solve linear systems using computationally efficient methods
CO3	Solve load flow problem to analyse the state of power systems
CO4	Formulate optimal power flow problem in power system networks
CO5	Analyse power system under short circuit conditions and infer the results to design a protective system

Mapping of course outcomes with program outcomes

	PO 1	PO 2	PO 3	PO 4	PO 5	PO 6	PO 7	PO 8	PO 9	PO 10	PO 11	PO 12
CO1	3	1	1	-	1	-	-	-	-	-	-	-
CO2	3	2	1	-	1	-	-	-	-	-	-	-
CO3	3	2	2	-	2	-	-	-	-	-	-	-
CO4	3	2	2	-	2	-	-	-	-	-	-	-
CO5	3	3	3	-	2	-	-	-	-	-	-	-

Assessment Pattern

Bloom's Category	Continuous Assessment Tests		End Semester Examination
	1	2	
Remember (K1)	10	10	20
Understand (K2)	10	10	20
Apply (K3)	20	20	40
Analyse (K4)	10	10	20
Evaluate (K5)	-	-	-
Create (K6)	-	-	-

Mark distribution

Total Marks	CIE	ESE	ESE Duration
150	50	100	3 hours

Continuous Internal Evaluation Pattern:

Attendance : 10 marks
 Continuous Assessment Test (2 numbers) : 25 marks
 Assignment/Quiz/Course project : 15 marks

End Semester Examination Pattern:

There will be two parts; Part A and Part B. Part A contain 10 questions with 2 questions from each module, having 3 marks for each question. Students should answer all questions. Part B contains 2 questions from each module of which student should answer any one. Each question can have a maximum 2 sub-divisions and carry 14 marks.

Course Level Assessment Questions**Course Outcome 1 (CO1):**

1. For the network shown in Fig. obtain the bus incidence matrix A. (K3)(PO1,PO2,PO3,PO5)

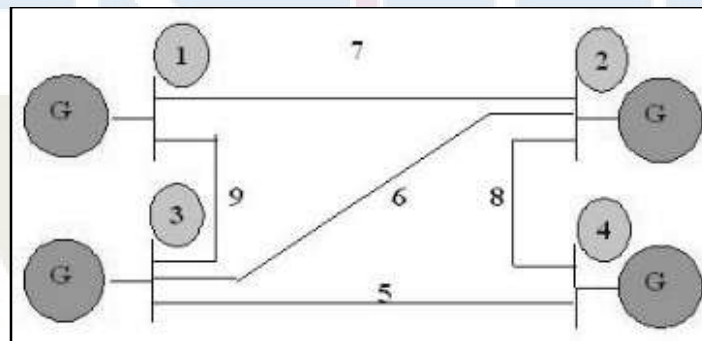

2. For the network in Fig, form the primitive matrices $[z]$ & $[y]$ and obtain the bus admittance matrix by singular transformation. (K2, K3)(PO1,PO2,PO3,PO5)

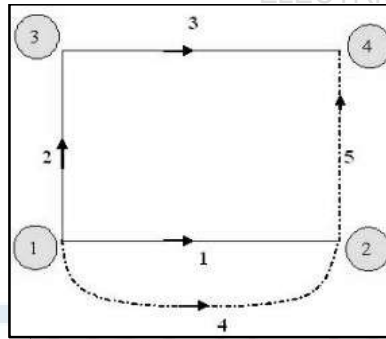

Course Outcome 2 (CO2):

1. Solve $Ax=b$ using Gaussian elimination, $A = \begin{bmatrix} 5 & -2 & -3 \\ -3 & 7 & -2 \\ -3 & -3 & 8 \end{bmatrix}$, $b = \begin{bmatrix} 4 \\ -10 \\ 6 \end{bmatrix}$ given (K2)(PO1,PO2,PO3,PO5)
2. Enumerate Tinney's optimal ordering schemes. (K2)(PO1,PO2,PO3,PO5)

Course Outcome 3 (CO3):

1. Exhibit the structure of fast decoupled load flow equations and DC load flow equations with numerical values for the 3 bus power system shown in the figure. (K3)(PO1,PO2,PO3,PO5)

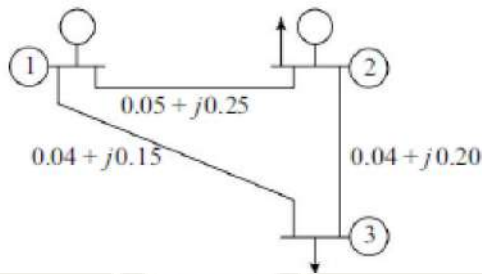

Load/Gen. Data				
Bus	Gen.		Load	
	MW	MVAR	MW	MVAR
1	0	0	0	0
2	100	50	50	25
3	0	0	75	30
4	0	0	100	50

2. Considering Bus 1 as slack bus, use DC load flow to obtain one iteration of load flow solution for the system shown below. (K2, K3)(PO1,PO2,PO3,PO5)

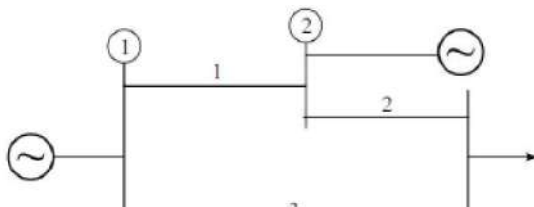

Line data (all are in p.u)

<i>Line number</i>	<i>Between buses</i>	<i>Line impedance</i>
1	1-2	$0 + j0.1$
2	2-3	$0 + j0.2$
3	1-3	$0 + j0.3$

Bus data (all are in p.u)

<i>Bus no.</i>	<i>Type</i>	<i>Generator</i>		<i>Load</i>		<i>Voltage magnitude</i>	<i>Reactive power limits</i>	
		<i>P</i>	<i>Q</i>	<i>P</i>	<i>Q</i>	<i>VI</i>	<i>Q_{min}</i>	<i>Q_{max}</i>
1	Slack	-	-	-	-	1.0	-	-8
2	P-V	5.3217	-	-	-	1.0	0	5.3217
3	P-Q	-	-	3.6392	0.5339	-	-	-

Course Outcome 4 (CO4):

1. Formulate the optimal power flow problem with equality constraints. (K2,K3)(PO1,PO2,PO3,PO5)
2. Discuss the equality and inequality constraints in optimal power flow. (K1)(PO1,PO2,PO3,PO5)
3. Incremental fuel costs in Rs/ mega watt-hour for a plant consisting of two units are given by

$$\lambda_1 = \frac{df_1}{dP_1} = 0.008P_1 + 8 \quad \lambda_2 = \frac{df_2}{dP_2} = 0.0096P_2 + 6.4$$

Assume that both units are operating at all times, determine the saving in fuel cost in Rs/hr for the economic distribution of total load of 900 MW between the two units of the plant compared with equal distribution of the same total load. (K3)(PO1,PO2,PO3,PO5)

Course Outcome 5 (CO5):

1. All lines in the network shown in figure have a positive sequence impedance of $j0.2$ p.u. Generators with transient reactances $j0.05$ p.u. are connected at buses 1 and 2. Assuming pre-fault voltage as $1 \angle 0^\circ$, for a three-phase to ground fault bus 3, find fault current, fault voltages at buses and currents in all the lines. Determine the fault level at bus 3. (K3, K4)(PO1,PO2,PO3,PO5)

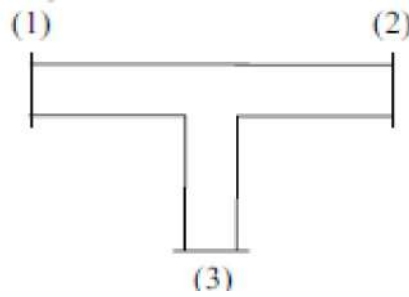

2. A 50-Hz turbo generator is rated 500 MVA, 22 kV. It is Y- connected and solidly grounded and is operating at rated voltage at no load. It is disconnected from the rest of the system. Its reactances are $X_d'' = X_1 = X_2 = 0.15$ and $X_0 = 0.05$ per unit. Determine the ratio of the subtransient line current for a single line to ground fault to the subtransient line current for a symmetrical fault. (K3)(PO1,PO2,PO3,PO5)

Model Question Paper

QP CODE:

PAGES:4

Reg.No: _____

Name: _____

**APJ ABDUL KALAM TECHNOLOGICAL UNIVERSITY EIGHT SEMESTER
B. TECH. DEGREE EXAMINATION,
MONTH & YEAR
Course Code: EET464**

Course Name: COMPUTER AIDED POWER SYSTEM ANALYSIS

Max. Marks: 100

Duration: 3 Hours

PART A

Answer all Questions. Each question carry 3 marks

1. Define tree, co-tree, link and branch of a graph.
2. How will the ZBUS matrix be modified, if any line is removed from the previous existing network, or the impedance value of the existing line gets modified.
3. Write short notes on Tinney's optimal ordering.
4. Discuss about triangular factorization of system matrices.
5. Compare NR load flow, decoupled load flow and fast decoupled load flow.
6. What is the principle underlying the decoupled approach in load flow solutions? Narrate its typical solution strategy.
7. Explain the constraints considered in formulating Optimal Power Flow.
8. Explain the concept of economic dispatch problem in the power system.
9. What is the need of performing short circuit analysis in a power system?

10. The Thevenin impedance and voltage at a fault point is $0.576\angle 84^\circ$ p.u. and $1\angle 0^\circ$ p.u. respectively. Determine the short circuit MVA for a base of 30MVA, 11kV.

PART B

Answer any one full question from each module. Each full question carry 14 marks

Module-1

11. a) Prove $Y_{\text{Bus}} = A^T y A$ where A is bus incidence matrix, y is primitive admittance matrix and Y_{Bus} is bus admittance matrix. (7)
 b) For the network shown in figure below, obtain Y_{Bus} by singular transformation. All line impedances are in p.u. (7)

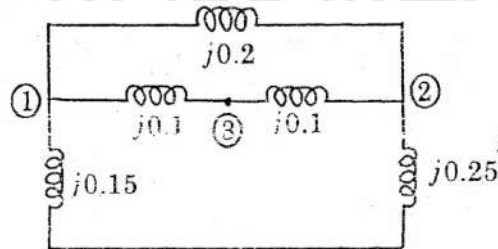

12. For the reactance network shown in figure find Z bus by direct determination (14)

Module-2

13. Find the L and U triangular factors of the symmetric matrix. (14)

$$\mathbf{M} = \begin{bmatrix} 2 & 1 & 3 \\ 1 & 5 & 4 \\ 3 & 4 & 7 \end{bmatrix}$$

14. Using the Gaussian elimination find the triangular factors of Y bus for the circuit given (14)

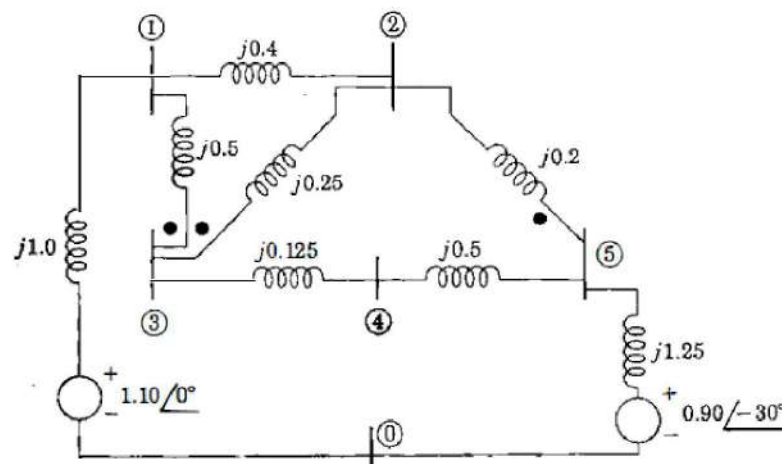

Module-3

15. For the three bus power system shown in figure, carry out one iteration of load flow solution by FDLF method. Line reactances are given in pu. (14)
16. a) Discuss the Newton Raphson algorithm of Load Flow (8)
 b) Stating the assumptions, discuss DC Load Flow (6)

Module-4

17. Explain the Optimal Power Flow problem and its solution by gradient method (with equality constraints only) (14)
18. a) Explain the formulation of optimal power flow problem and its solution by Newton method (8)
 b) Explain security constrained optimal power flow (6)

Module-5

19. For the system shown in figure a three phase fault occurs in bus 1. Using Z_{Bus} method, find the short circuit current in the fault, currents in line 1-2 and 1-3 and bus voltages. Prefault system is on no load with 1pu voltage and prefault currents are zero. (14)
20. Obtain the sequence network for a LL fault through impedance at the terminals of an unloaded synchronous generator. (14)

Syllabus**Module I (7 hours)**

Overview of graph theory - tree, co-tree and bus incidence matrix, development of network matrices Z_{bus} and Y_{bus} from graph theoretic approach (singular transformation only), building algorithm for bus impedance matrix for elements without mutual coupling.

Module II (8 hours)

Review of solution of linear system of equations by Gauss-Jordan method, Gauss elimination, and LDU factorization. Inversion of Y_{bus} for large systems using LDU factors, Tinney's Optimal ordering.

Module III (7 hours)

Review of Load Flow analysis, Newton-Raphson method(only qualitative analysis), Fast Decoupled Load Flow and DC Load Flow (numerical problems upto two iterations).

Module IV (7 hours)

Review of economic load dispatch, formulation of optimal power flow with active power cost minimization, Solution of OPF using Gradient and Newton's methods (Qualitative analysis only), Security Constrained Optimal Power Flow (concept only).

Module V (7 hours)

Network fault calculations using Z_{bus} , algorithm for calculating system conditions after fault – three phase to ground fault.

Text Books:

1. Stagg and El Abiad, "Computer Methods in Power System Analysis", McGraw Hill, 1968.
2. G. L. Kusic, Computer Aided Power System Analysis, PHI, 1989
3. John J. Grainger, William D. Stevenson, Jr., Power System Analysis, Tata McGraw-Hill Series in Electrical and Computer Engineering.

References:

1. I. J. Nagrath and D. P. Kothari, "Modern Power System Analysis", Tata McGraw Hill, 1980.
2. J. Arriliga and N.R. Watson, Computer Modelling of Electrical Power Systems, 2/e, John Wiley, 2001.
3. L. P. Singh, "Advanced Power System Analysis and Dynamics", 3/e, New Age Intl, 1996.
4. M. A. Pai, Computer Techniques in Power Systems Analysis, Tata McGraw-Hill, Second edition 2005.
5. Arthur R. Bergen, Vijay Vittal, Power Systems Analysis (English) 2nd Edition, Pearson Higher Education
6. Wood, Allen J., Bruce F. Wollenberg, and Gerald B. Sheblé. Power generation, operation, and control. John Wiley & Sons, 2013

Course Content and Lecture Schedule:

Sl. No.	Topic	No. of Lecture Hrs
1	Module I (7 Hrs)	
1.1	Introduction, Network Equation, Concept of Linear Graph – tree, cotree	1
1.2	Bus Incidence matrix, A	1
1.3	Formation of Y_{bus} and Z_{bus} by singular transformation, Numerical problem	2
1.4	Z_{bus} building algorithm without mutual coupling(derivation not required), Numerical example	3
2	Module II (8 Hrs)	
2.1	Solution of linear system of equations by Gauss Jordan method and Gauss elimination method, Numerical problems	3

2.2	Triangular factorization –LDU factors, Numerical problems	2
2.3	Inversion of the Y_{BUS} matrix for large systems, Numerical problems	2
2.4	Tinney's Optimally Ordering	1
3	Module III (7 Hrs)	
3.1	Review of Load Flow	1
3.2	Newton-Raphson method (Qualitative analysis only)	2
3.3	Fast Decoupled Load Flow (Numerical problems up to 2 iterations)	2
3.4	DC Load Flow (Numerical problems up to 2 iterations)	2
4	Module IV (7 Hrs)	
4.1	Review of Economic Load Dispatch - Economic dispatch of generation without and with transmission line losses	2
4.2	Concept of optimal power flow – formulation with equality and inequality constraints (with active power cost minimization)	2
4.3	Solution of OPF using Gradient and Newton method (Qualitative analysis only)	2
4.4	Security Constrained Optimal Power Flow (concept only).	1
5	Module V (7 Hrs)	
5.1	Symmetrical and Unsymmetrical fault calculations using Z_{BUS} – Numerical Problems (Symmetrical faults up to 3 bus systems)	4
5.2	Algorithm for SC calculations for balanced 3 phase network – three phase to ground fault only –Numerical problem	3
		36 hrs

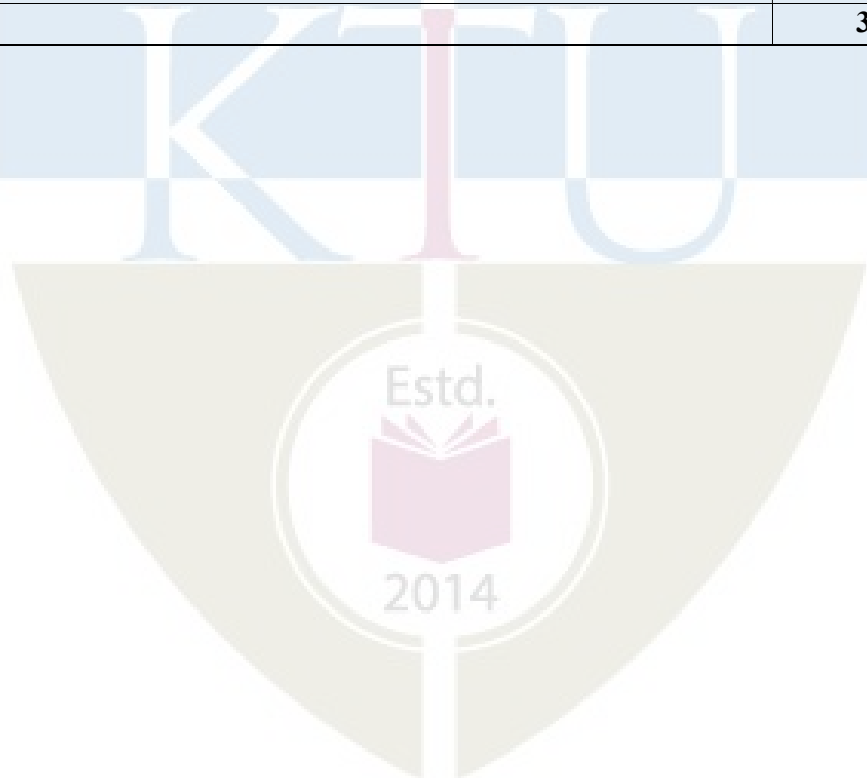

CODE	COURSE NAME	CATEGORY	L	T	P	CREDIT
EET474	MACHINE LEARNING	PEC	2	1	0	3

Preamble: This course will enable students to:

- 1) Develop an appreciation for what is involved in learning models from data.
- 2) Understand a wide variety of learning algorithms.
- 3) Understand how to evaluate models generated from data.
- 4) Apply the algorithms to a real-world problem, optimize the models learned and report on the expected accuracy that can be achieved by applying the models.

Prerequisite: Nil

Course Outcomes: After the completion of the course the student will be able to:

CO1	Understand various basic learning techniques
CO2	Perform dimensionality reduction for multivariate problems
CO3	Implement machine learning solutions to classification, regression, and clustering problems
CO4	Use Perceptron modelling based learning techniques and Support Vector Machines to design solutions
CO5	Design and analyse machine learning experiments for real-life problems

Mapping of course outcomes with program outcomes

	PO 1	PO 2	PO 3	PO 4	PO 5	PO 6	PO 7	PO 8	PO 9	PO 10	PO 11	PO 12
CO 1	3	3	-	-	-	-	-	-	-	-	-	3
CO 2	3	3	2	-	-	-	-	-	-	-	-	3
CO 3	3	3	3	-	-	-	-	-	-	-	-	3
CO 4	3	3	-	-	-	-	-	-	-	-	-	3
CO 5	3	3	2	-	-	-	-	-	-	-	-	3

Assessment Pattern:

Bloom's Category	Continuous Assessment Tests		End Semester Examination
	1	2	
Remember (K1)	10	10	20
Understand (K2)	10	10	20
Apply (K3)	20	20	50
Analyse (K4)	10	10	10
Evaluate (K5)			
Create (K6)			

Total Marks	CIE marks	ESE marks	ESE Duration
150	50	100	03 Hrs

End Semester Examination Pattern: There will be two parts; Part A and Part B.

Part A contains 10 questions with 2 questions from each module, having 3 marks for each question. Students should answer all questions.

Part B contains 2 questions from each module of which student should answer any one. Each question carries 14 marks and can have maximum 2 sub-divisions.

Course Level Assessment Questions

Course Outcome 1 (CO1):

1. Distinguish between overfitting and underfitting. How it can affect model generalization?
2. Explain bias- variance dilemma.
3. Distinguish between classification and regression with an example.

Course Outcome 2 (CO2)

1. Define VC dimension. Show that an axis aligned rectangle can shatter 4 points in 2 dimensions.
2. Compare Simple Regression, Multiple Regression and Multivariate Regression.
3. Describe any two techniques used for Ensemble Learning.

Course Outcome 3(CO3):

1. Given a linearly separable dataset with one group containing 5 instances and a second group containing 20 instances, is k-means clustering with $k=2$ guaranteed to find these two clusters? Explain why or why not.
2. Explain Basic decision tree learning algorithm for classification problems
3. Draw the decision tree structure for $X_1 \text{ XOR } X_2$

Course Outcome 4 (CO4):

1. What is kernel trick? Why does the kernel trick allow us to solve SVMs with high dimensional feature spaces, without significantly increasing the running time?
2. Can you represent the following Boolean function with a single binary perceptron? If yes, show the weights. If not, explain why not in 1-2 sentences.

A	B	$f(A,B)$
1	1	0
0	0	0
1	0	1
0	1	0

3. Formulate the SVM regression problem using insensitive loss.

Course Outcome 5 (CO5):

- 1) Suppose that the datamining task is to cluster the following seven points (with (x,y) representing location) into two clusters A1(1,1), A2(1.5,2), A3(3,4), A4(5,7), A5(3.5,5), A6(4.5,5), A7(3.5,4.5) The distance function is City block distance. Suppose initially we assign A1,A5 as the centre for each cluster respectively. Using the K-means algorithm to find the three clusters and their centres after two round of execution.
- 2) Explain the concept of Reinforcement Learning with a practical example.
- 3) Draw the structure of CNN, and explain the classification process with an example.

Model Question Paper

PAGES: 3

QP CODE:

Reg.No: _____

Name: _____

**APJ ABDULKALAM TECHNOLOGICAL UNIVERSITY
EIGHTH SEMESTER B.TECH DEGREE
EXAMINATION MONTH & YEAR**

Course Code: **EET474**

Course Name: **MACHINE LEARNING**

Max. Marks: 100

Duration: 3 Hours

PART A

Answer all Questions. Each question carries 3 Marks

- 1 Explain false negative, false positive, true negative and true positive with a simple example.
- 2 While using all features of a data set, if we achieve 100% accuracy on my training set, but ~70% on validation set, discuss whether we might see an underfitting, overfitting or perfect model? Please justify.
- 3 Differentiate a Perceptron and Logistic Regression?
- 4 Explain the difference between L1 and L2 regularization.
- 5 Can we design a neural network without an activation function? Justify your answer.
- 6 Is Occam's Razor an inductive bias scenario? State reasons with examples.
- 7 What are the standard use cases for Bayesian belief networks? What is its basic difference with respect to Hidden Markov Models?
- 8 We have designed an RBF kernel in SVM with high Gamma value. What does this signify?
- 9 In a binary classification problem, there are 3 models each with 70% accuracy. If we want to ensemble these models using majority voting method, what will be the maximum accuracy we can get?
- 10 What are the basic elements of reinforcement learning?

PART B

Answer any one full question from each module. Each question carries 14 Marks

Module 1

- 11 a) Discuss the influence of model complexity on underfitting and overfitting? (7 Marks)
- b) How do we measure the power of a classifier? What is the VC dimension for a linear classifier? (7 Marks)
- 12 a) List out the critical assumptions for applying linear regression, with emphasis to Heteroscedasticity. How can we improve the accuracy of a linear regression model? (9 Marks)
- b) Discuss L1 and L2 regularization? (5 Marks)

Module 2

- 13 a) Explain Naïve Bayes Classifier (10 Marks)
- b) Discuss the inconsistencies in Bayesian inference (4 Marks)
- 14 a) What are the various multivariate learning techniques? Discuss with use cases and applications (7 Marks)
- b) Suppose we have 3 cards identical in form except that both sides of the first card are colored red, both sides of the second card are colored black, and one side of the third card is colored red and the other side is colored black. The 3 cards are mixed up in a hat, and 1 card is randomly selected and put down on the ground. If the upper side of the chosen card is colored red, what is the probability that the other side is colored black? (7 Marks)

Module 3

- 15 a) Consider the following data where x and y are the 2 input variables and Class is the dependent variable. (10 Marks)

x	y	Class
-1	1	-
0	1	+
0	2	-
1	-1	-
1	0	+
1	2	+
2	2	-
2	3	+

Draw the scatter plot for this dataset in a two dimensional space. Assuming a Euclidian distance of in 3-NN, to which class will the new point of $x=1$ and $y=1$ belong to?

- b) Write four termination conditions for k-means clustering algorithm (4 Marks)
- 16 a) Describe the expectation-maximization algorithm? (9 Marks)
- b) Write short note on Random Forest Decision tree (5 Marks)

Module 4

- 17 a) Write the pseudo code for back propagation algorithm and explain? (10 Marks)
- b) Differentiate CNN from RNN with respect to its use cases. (4 Marks)
- 18 a) Discuss the geometric intuition behind SVMs.

Discuss soft margin and hard margin SVMs (10 Marks)

b) When do you apply “Kernel Trick”? (4 Marks)

Module 5

19 a) In an election, N candidates are competing against each other and people are voting for either of the candidates. Voters don't communicate with each other while casting their votes. Which ensemble method works similar to above-discussed election procedure? (11 Marks)

b) Illustrate K-Arm bandit algorithm with an example (3 Marks)

20 a) Discuss problem characteristics in the Reinforcement Learning method (5 Marks)

b) With an example, demonstrate the Q-Function and Q-Learning algorithm, assuming deterministic reward and action. (9 Marks)

Syllabus

Module – 1

Introduction: What Is Machine Learning? Examples of Machine Learning Applications, Learning Associations, Classification, Regression, Unsupervised Learning, Reinforcement Learning

Supervised Learning: Learning a Class from Examples, Vapnik-Chervonenkis (VC) Dimension, Noise, Learning Multiple Classes, Regression, Model Selection and Generalization

Parametric Methods: Maximum Likelihood Estimation, Evaluating an Estimator: Bias and Variance, Parametric Classification, Regression, Tuning Model Complexity and Model Validation: Bias/Variance Dilemma

Module – 2

Bayesian Learning: Introduction to conditional probability and conditional expectations, Bayes theorem, Bayes theorem and concept learning, ML and LS error hypothesis, ML for predicting probabilities, Naive Bayes classifier, Bayesian belief networks,

Multivariate Data, Multivariate Classification, Multivariate Regression

Module – 3

Clustering: Introduction, Mixture Densities, k-Means Clustering, Expectation-Maximization Algorithm, Other methods of clustering.

Nonparametric Methods: Nonparametric Density Estimation, Histogram Estimator, Kernel Estimator, k-Nearest Neighbor Estimator

Decision Tree Based Learning: Decision tree representation, Appropriate problems for decision tree learning, Basic decision tree learning algorithm, hypothesis space search in decision tree learning, Inductive bias in decision tree learning, Issues in decision tree learning

Module – 4

Neural Networks: Neural Networks as a Paradigm for Parallel Processing, Feed Forward Networks, Backpropagation Algorithm, Fundamentals of Deep Learning, Basic Deep Learning Architectures

Local Models: Competitive Learning, Radial Basis Functions, Incorporating Rule-Based Knowledge

Kernel Machines: SVM Formulations, Optimal Separating Hyperplane, The Nonseparable Case: Soft Margin Hyperplane, ν -SVM, Kernel Types, Kernel Machines for Regression

Module – 5

Combining Multiple Learners: Rationale, Generating Diverse Learners, Model Combination Schemes, Voting, Error-Correcting Output Codes, Bagging, Boosting

Reinforcement Learning: The State Space Theory, K-Armed Bandit, Elements of Reinforcement Learning, Q Learning

Text Books:

- Pattern Recognition and Machine Learning. Christopher Bishop. Springer. 2006. [CB-2006]
- Machine Learning. Tom Mitchell, McGraw-hill, 1997

Reference Books:

- Understanding Machine Learning. Shai Shalev-Shwartz and Shai Ben-David. Cambridge University Press. 2017. [SS-2017]
- Haykin, Simon. Neural networks and learning machines, 3/E. Pearson Education India, 2010.
- The Elements of Statistical Learning. Trevor Hastie, Robert Tibshirani and Jerome Friedman. Second Edition. 2009. [TH-2009]
- Foundations of Data Science. Avrim Blum, John Hopcroft and Ravindran Kannan. January 2017. [AB-2017]

Estd.



2014

Course Contents and Lecture Schedule:

No	Topic	No. of Lectures
1	Module 1	(7 hours)
1.1	What Is Machine Learning? Examples of Machine Learning Applications, Learning Associations, Classification, Regression, Unsupervised Learning, Reinforcement Learning	2
1.2	Supervised Learning: Learning a Class from Examples, Vapnik-Chervonenkis (VC) Dimension, Noise, Learning Multiple Classes, Regression, Model Selection and Generalization	2
1.3	Parametric Methods: Maximum Likelihood Estimation, Evaluating an Estimator: Bias and Variance, Parametric Classification, Regression, Tuning Model Complexity and Model Validation: Bias/Variance Dilemma	3
2	Module 2	(7 hours)
2.1	Bayesian Learning: Introduction to conditional probability and conditional expectations, Bayes theorem, Bayes theorem and concept learning, ML and LS error hypothesis,	3
2.2	ML for predicting probabilities, Naive Bayes classifier, Bayesian belief networks,	2
2.3	Multivariate Data, Multivariate Classification, Multivariate Regression	2
3	Module 3	(7 hours)
3.1	Clustering: Introduction, Mixture Densities, k-Means Clustering, Expectation-Maximization Algorithm, Other methods of clustering.	2
3.2	Nonparametric Methods: Nonparametric Density Estimation, Histogram Estimator, Kernel Estimator, k-Nearest Neighbor Estimator	2
3.3	Decision Tree Based Learning: Decision tree representation, Appropriate problems for decision tree learning, Basic decision tree learning algorithm, hypothesis space search in decision tree learning, Inductive bias in decision tree learning, Issues in decision tree learning	3
4	Module 4	(7 hours)
4.1	Neural Networks: Neural Networks as a Paradigm for Parallel Processing, Feed Forward Networks, Backpropagation Algorithm, Fundamentals of Deep Learning, Basic Deep Learning Architectures	2
4.2	Local Models: Competitive Learning, Radial Basis Functions, Incorporating Rule-Based Knowledge	2
4.3	Kernel Machines: SVM Formulations, Optimal Separating Hyperplane, The Nonseparable Case: Soft Margin Hyperplane, ν -SVM, Kernel Types, Kernel Machines for Regression	3
5	Module 5	(7 hours)
5.1	Combining Multiple Learners: Rationale, Generating Diverse Learners	2
5.2	Model Combination Schemes, Voting, Error-Correcting Output Codes, Bagging, Boosting	2
5.3	Reinforcement Learning: The State Space Theory, K-Armed Bandit, Elements of Reinforcement Learning, Q Learning	3

Assessment Pattern:

Total Marks	CIE marks	ESE marks	ESE Duration
150	50	100	03 Hrs

Bloom's Category	Continuous Assessment Tests		End Semester Examination
	1	2	
Remember (K1)	10	10	20
Understand (K2)	15	15	30
Apply (K3)	25	25	50
Analyse (K4)			
Evaluate (K5)			
Create (K6)			

End Semester Examination Pattern: There will be two parts; Part A and Part B. **Part A** contains 10 questions with 2 questions from each module having 3 marks for each question. Students should answer all questions.

Part B contains 2 questions from each module of which student should answer anyone. Each question carries 14 marks and can have sub-divisions.

Course Level Assessment Questions:**Course Outcome 1 (CO1)**

1. Discuss the characteristics of non-linear systems? (K1, PO1)
2. Model a given nonlinear system. (K2, PO1, PO12)
3. Identify and classify the equilibrium solutions of nonlinear systems. (K2, PO1)
4. Analyse the qualitative behaviour of a given system about its equilibrium points and plot a rough sketch of the phase portrait. (K3, PO2, PO12)
5. What are bifurcations? (K1, PO1)
6. Problems to identify the type of bifurcation. (Saddle-node and Pitchfork only) (K2, PO1)

Course Outcome 2 (CO2):

1. Identify the existence of limit cycles using the Poincare Bendixson theorem. (K3, PO2, PO12)
2. Identify the non-existence of limit cycles using Bendixson's theorem. (K3, PO2, PO12)
3. Problems to check the existence and uniqueness of initial value problems. (K2, PO2)

Course Outcome 3 (CO3):

1. Explain the concept of stability (local and global), instability in the sense of Lyapunov. (K2, PO1)
2. Apply Lyapunov direct/indirect methods to analyze the stability of nonlinear systems. (K3, PO2, PO12)
3. Analyze the stability using LaSalle's invariance theorem. (K3, PO2, PO12)
4. Construct Lyapunov functions using Variable gradient and Krasovskii's method. (K3, PO2)
5. Explain memoryless systems and passivity. (K1, PO1)
6. Examine whether a given system transfer function is positive real or not. (K2, PO1)
7. Explain sector nonlinearity and absolute stability. (K1, PO1)
8. Define KYP Lemma (without proof). (K1, PO1)
9. Examine the stability of the sector nonlinearity using Circle criterion. (K3, PO2)
10. Explain Popov criterion for stability. (K1, PO1)

Course Outcome 4 (CO5):

1. Define feedback control problem - state feedback and output feedback. (K1, PO1)
2. Use state feedback control law for stabilizing a given system. (K2, PO1)
3. Explain the concept of input-state and input-output linearization. (K1, PO1)
4. Examine whether a given system is input-output linearizable. (K3, PO2, PO12)
5. Explain stabilization via integral control. (K1, PO1)



Model Question Paper		PAGES: 2	
QP CODE:			
Reg.No: _____			
Name: _____			
APJ ABDUL KALAM TECHNOLOGICAL UNIVERSITY EIGHTH SEMESTER B.TECH DEGREE EXAMINATION MONTH & YEAR			
Course Code: EET416 Course Name: NONLINEAR SYSTEMS			
Max. Marks: 100		Duration: 3 Hours	
PART A Answer all questions Each question carries 3 marks			
1	Qualitatively analyse the following nonlinear system about the equilibrium point $\dot{y} + 0.5 \dot{y} + 2y + y^2 = 0$	3	
2	What are limit cycles? Give significance and classify them based on stability.	3	
3	Define Poincare Index theorem. Check whether there exist periodic orbits for the system defined below using Poincare index theorem. $\dot{y} - y + y^3 = 0$	3	
4	State the conditions for uniqueness and existence of solutions.	3	
5	Check the stability of the nonlinear system using Lyapunov direct method. $(x_1)' = x_2$ $(x_2)' = [-x_1 - 3x_2]$	3	
6	What is meant by domain of attraction of a given system?	3	
7	What are positive real transfer functions? Check whether $G(s) = [s + 2] / [s + 3]$	3	

		is a positive real transfer function.	
8		Define absolute stability.	3
9		Find the relative degree for the controlled Van der Pol equation with output $y = x_1$ $(x_1)' = x_2$ $(x_2)' = -x_1 + \epsilon (1 - [x_1]^2) [x_2] + u, \epsilon > 0$	3
10		What is the concept of gain scheduling?	3
PART B (Answer any one full question from each module)			
Module 1			
11	a)	Find the equilibrium points of the system defined by the system given below and determine the type of each isolated equilibrium point. Also, plot a rough sketch of the qualitative behaviour near the equilibrium points. $(x_1)' = 5x_1 - x_1 x_2$ $(x_2)' = 3x_2 + x_1 x_2 - 3 [x_2]^2$	7
	b)	The nonlinear dynamic equation for a pendulum is given by $ml((\theta))'' = -mgsin(\theta) - kl((\theta))'$ where ' $l=l$ ' is the length of the pendulum, ' m ' is the mass of the bob, and θ is the angle subtended by the rod and the vertical axis through the pivot point. ' g ' is the gravitational constant. Choose ' $k/m=l$ '. Find all the equilibria of the system and determine if the equilibria are stable or not.	7
12	a	What is saddle-node and Pitch fork bifurcation?	6
	b	Obtain the linearized representation of the following system around the origin and check the stability of the linearised system about the origin. $(x_1)' = [x_2]^2 + x_1 \cos x_2$ $(x_2)' = x_2 + (x_1 + 1)x_1 + x_1 \sin x_2$	8

Module 2			
13	a	Define a) Bendixson theorem b) Poincare - Bendixson theorem	6
	c	Check whether the following functions are locally Lipschitz. Give reasons for your claim. (i) $f(x,y) = 2xy^{1/3}$ for $(x,y) = [0,0]$ (ii) $f(t,x) = 2tx^2$ for $(x,y) = [0,3]$	8
14	a)	Obtain the Lipschitz constant for (i) $f(t,y) = -3y + 2$ (ii) $f(t,y) = 2ty^2$	7
	b	Check whether the system given below has a stable or unstable limit cycle. $\begin{aligned} (\dot{x}_1) &= x_2 - x_1 ([x_1]^2 + [x_2]^2 - 1) \\ (\dot{x}_2) &= -x_1 - x_2 ([x_1]^2 + [x_2]^2 - 1) \end{aligned}$	7
Module 3			
15		Explain the concept of the domain of attraction using an example.	5
	c)	Use variable gradient method to find a suitable Lyapunov function for the system given below $\begin{aligned} (\dot{x}_1) &= -2x_1 \\ (\dot{x}_2) &= -2x_2 + 2x_1 [x_2]^2 \end{aligned}$	9
16	a	Define stability in the sense of Lyapunov. What is the difference between asymptotic and exponential stability?	6
	b	State LaSalle's invariance principle. Show that the origin is locally asymptotically stable for the following system using LaSalle's principle. $\begin{aligned} (\dot{x}_1) &= x_2 \\ (\dot{x}_2) &= -3x_2 - [x_1]^3 \end{aligned}$	8

Module 4			
17	a)	What is KYP Lemma?	4
	b	State circle criterion. Determine a stability sector from the Nyquist plot of the system using circle criterion. $G(s) = 4/((s - 1)(s/3 + 1)(s/5 + 1))$	10
18	a)	Using circle criterion, find a sector [a,b] for which the following system is absolutely stable. $G(s) = 1/((s + 1)(s + 2)(s + 3))$	8
	b	Describe Popov stability criterion.	6
Module 5			
19	a)	Define the following terms (i) Diffeomorphism (ii) Lie derivative	6
	b	Check whether the given system can be input-output linearized for output $y = x_1$ $(x_1)' = x_1$ $(x_2)' = x_2 + u$	8
20	a)	What is input-output linearization?	6
	b	With a suitable feedback control law, linearize the following system $(x_1)' = a \sin x_2$ $(x_2)' = - [x_1]^2 + u$	8

Syllabus

Module 1

Introduction and background (7 hours)

Non-linear system characteristics and mathematical modelling of a non-linear system, Classification of equilibrium points, Stability of a nonlinear system based on equilibrium points, Bifurcation (construction not included), Phase plane analysis of nonlinear systems.

Module 2

Nonlinear characteristics (8 hours)

Periodic solution of nonlinear systems and existence of limit cycle, Open sets, closed sets, connected sets, Invariant set theorem, Bendixson's theorem and Poincare-Bendixson criteria, Existence and uniqueness of solutions to nonlinear differential equations (Proofs not required), Lipschitz condition.

Module 3

Stability Analysis (7 hours)

Lyapunov stability theorems (Proofs not required)- local stability - local linearization and stability in the small- region of attraction, the direct method of Lyapunov, Construction of Lyapunov functions - Variable gradient and Krasovskii's methods, La Salles's invariance principle.

Module 4

Analysis of feedback systems (8 hours)

Passivity and loop transformations, KYP Lemma (Proof not required), Absolute stability, Circle Criterion, Popov Criterion.

Module 5

Nonlinear control systems design (8 hours)

Feedback linearization, Input state linearization method, Input-output linearization method, Stabilization - regulation via integral control- gain scheduling.

Text Book:

1. Khalil H. K., "Nonlinear Systems", 3/e, Pearson, 2002
2. Gibson J. E., "Nonlinear Automatic Control", Mc Graw Hill, 1963
3. Slotine J. E. and Weiping Li, "Applied Nonlinear Control", Prentice-Hall, 1991

References:

1. Alberto Isidori, "Nonlinear Control Systems: An Introduction", Springer-Verlag, 1985.
2. M. Vidyasagar, "Nonlinear Systems Analysis", Prentice-Hall, India, 1991.
3. Shankar Sastry, "Nonlinear System Analysis, Stability and Control", Springer, 1999.

Course Contents and Lecture Schedule

No	Topic	No. of Lectures
1	Introduction and background (7 hours)	
1.1	Non-linear system characteristics and mathematical modelling of a non-linear system.	2
1.2	Classification of equilibrium points, Stability of a nonlinear system based on equilibrium points.	2
1.3	Bifurcation (construction not included), Phase plane analysis of nonlinear systems.	3
2	Nonlinear characteristics (8 hours)	
2.1	Periodic solution of nonlinear systems and existence of limit cycles	2
2.2	Open sets, closed sets, connected sets, Invariant set theorem, Bendixson's theorem and Poincare-Bendixson criteria	4
2.3	Existence and uniqueness of solutions to nonlinear differential equations (Proofs not required), Lipschitz condition.	2
3	Stability Analysis (7 hours)	
3.1	Lyapunov stability theorems (Proofs not required)- local stability - local linearization and stability in the small- region of attraction	2
3.2	The direct method of Lyapunov	2
3.3	Construction of Lyapunov functions, La Salles's invariance principle.	3
4	Analysis of feedback systems (8 hours)	

4.1	Passivity and loop transformations	2
4.2	KYP Lemma (Proof not required), Absolute stability	2
4.3	Circle Criterion	2
4.4	Popov Criterion	2
5	Nonlinear control systems design (8 hours)	
5.1	Feedback linearization	2
5.2	Input state linearization method	2
5.3	Input-output linearization method	2
5.4	Stabilization - regulation via integral control- gain scheduling	2

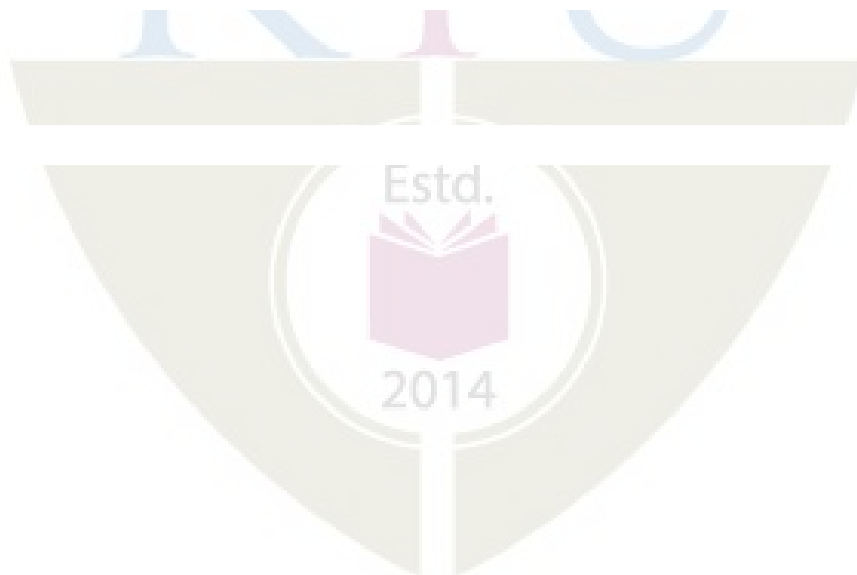

CODE	COURSE NAME	CATEGORY	L	T	P	CREDIT
EET426	SPECIAL ELECTRIC MACHINES	PEC	2	1	0	3

Preamble: This course gives an overview of special electrical machines for control and industrial applications.

Prerequisite: EET202 DC Machines and Transformers

EET307 Synchronous and Induction Machines

Course Outcomes: After the completion of the course, the student will be able to:

CO 1	Analyse the performance of different types of permanent magnet motors.
CO 2	Analyse the performance of a stepper motor.
CO 3	Analyse the performance of different types of reluctance motors.
CO 4	Explain the construction and principle of operation of servo motors, single phase motors and linear motors.
CO 5	Analyse the performance of linear induction motors.

Mapping of course outcomes with program outcomes

	PO1	PO2	PO3	PO4	PO5	PO6	PO7	PO8	PO9	PO10	PO11	PO12
CO 1	3	2	-	-	-	2	-	-	-	-	-	2
CO 2	3	2	-	-	-	2	-	-	-	-	-	2
CO 3	3	2	-	-	-	2	-	-	-	-	-	2
CO 4	3	2	-	-	-	2	-	-	-	-	-	2
CO 5	3	2	-	-	-	2	-	-	-	-	-	2

Assessment Pattern

Bloom's Category	Continuous Assessment Tests		End Semester Examination
	1	2	
Remember	15	15	30
Understand	25	25	50
Apply	10	10	20
Analyse			
Evaluate			
Create			

Mark distribution

Total Marks	CIE	ESE	ESE Duration
150	50	100	3 hours

Continuous Internal Evaluation Pattern:

Attendance	: 10 marks
Continuous Assessment Test (2 numbers)	: 25 marks
Assignment/Quiz/Course project	: 15 marks

End Semester Examination Pattern: There will be two parts; Part A and Part B. Part A contains 10 questions (each carrying 3 marks) with 2 questions from each module. Students should answer all questions. Part B contains 2 questions from each module, out of which students should answer any one. Each question can have maximum 2 sub-divisions and carries 14 marks.

Part A: 10 Questions x 3 marks=30 marks, **Part B:** 5 Questions x 14 marks =70 marks

Course Level Assessment Questions**Course Outcome 1 (CO1):**

1. Explain the principle of operation of any motor. [K1, PO1]
2. List the permanent magnets used in motors and explain their magnetization characteristics. [K1, PO1]
3. Problems based on emf and torque of PMBLDC motor and PMSM. [K2, PO2]

Course Outcome 2 (CO2):

1. Explain the working of any type of stepper motor with a neat diagram. [K1, PO1]
2. Explain the different configurations for switching the phases of a stepper motor. [K2, PO1]
3. Numerical problems from stepper motors. [K2, PO2]

Course Outcome 3(CO3):

1. Derive the torque equation of any motor. [K2, PO1]
2. Draw the phasor diagram of a synchronous reluctance motor. [K1, PO1]
3. Explain any two power converter circuits used for the control of SRM. [K1, PO1]

Course Outcome 4 (CO4):

1. Explain the constructional details of any servo motor. [K1, PO1]
2. Discuss the role of servo motors in automation systems. [K2, PO12]
5. Explain the constructional details and working principle of any motor. [K1, PO1]

Course Outcome 5 (CO5):

1. Explain the principle of operation of a LIM. [K1, PO1]
2. What are the different types of Linear motors?. [K1, PO1]
3. Derive the thrust equation of a LIM. [K2, PO1]

Model Question Paper

QP CODE:

PAGES:

Reg. No: _____

Name: _____

**APJ ABDUL KALAM TECHNOLOGICAL UNIVERSITY EIGHTH SEMESTER
B.TECH DEGREE EXAMINATION, MONTH & YEAR**

Course Code: EET426

Course Name: SPECIAL ELECTRIC MACHINES

Max. Marks: 100

Duration: 3 Hours

PART A (3 x 10 = 30 Marks)

Answer all Questions. Each question carries 3 Marks

1. Explain the constructional details of PMBLDC Motor.
2. Explain the sensor less control of PMSM.
3. Define the following terms as applied to stepper motors (i) Holding Torque (ii) Step accuracy (iii) Detent position.
4. What is meant by micro stepping in stepper motors? What are its advantages?
5. Draw the torque -slip characteristics of a Reluctance motor and explain its shape.
6. Explain the drawbacks of a Switched Reluctance motor.
7. What are the applications of servo motors?
8. Draw and explain the performance characteristics of an ac servo motor.
9. Explain the working principle of a hysteresis motor.
10. Derive the expression for linear force in LIM.

PART B (14 x 5 = 70 Marks)

Answer any one full question from each module. Each question carries 14 Marks

Module 1

11. (a) Explain the principle of operation of the PMBLDC motor with a neat circuit diagram showing the complete drive circuit. (10 marks)
- (b) Differentiate trapezoidal and sinusoidal back emf permanent magnet motors. (4 marks)
12. (a) Explain the demagnetisation characteristics and choice of permanent magnets in a Brushless DC motor. (10 marks)
- (b) Explain the constructional details and working principle of the permanent magnet dc motor. (4 marks)

Module 2

13. (a) With neat sketches, explain the constructional details and working principle of the variable reluctance stepper motor. (10 marks)
 (b) List any four applications of stepper motors. (4 marks)
14. (a) A permanent magnet stepper motor is driven by a series of pulses of duration 20ms. It has 4 stator poles and 6 rotor poles. How long will it take for the motor to make a complete rotation? (4 marks)
 (b) Compare variable reluctance, permanent magnet and hybrid stepper motors. (6 marks)
 (c) Explain monofilar and bifilar windings. (4 marks)

Module 3

15. (a) With neat sketches explain the construction and operation of 8/6 SRM. (10 marks)
 (b) Draw and explain $n+1$ switches and diode configuration power converter for the SRM. (4 marks)
16. (a) Derive the torque equation of a synchronous reluctance motor. (8 marks)
 (b) Explain the basic principle of operation of a synchronous reluctance motor. (6 marks)

Module 4

17. (a) With the help of a schematic diagram, explain the working of the field controlled d.c servomotor. (8 marks)
 (b) Explain the working and applications of split field servomotors. (6 marks)
18. (a) Explain the constructional features and working principle of AC Servomotors. (10 marks)
 (b) Explain the characteristic difference between AC and DC servomotors. (4 marks)

Module 5

19. (a) Describe the properties of the materials used for the rotor construction of hysteresis motors. (5 marks)
 (b) Why is compensating winding used in AC series motors? Draw a series motor with different types of compensating windings. (5 marks)
 (c) What are the modifications to be made in the DC series motor to operate it in an AC supply? (4 marks)
20. (a) Develop the equivalent circuit of a LIM and describe the main factors affecting its performance. (10 marks)
 (b) Explain the transverse edge effect in LIM. (4 marks)

Syllabus

Module 1 (8 hours)

Permanent Magnet DC Motors – construction – principle of operation.

PM Brushless DC motor- Brushless DC motor-construction - permanent magnets – different types- demagnetization characteristics – arrangement of permanent magnets – magnetization of permanent magnets – axial and parallel magnetizations- principle of operation – Control of BLDC motor - applications.

Permanent Magnet Synchronous Motors-construction - principle of operation –Control of PMSM - Self control - Sensor less Control– applications - Comparison with BLDC motors.

Module 2 (7 hours)

Stepper motors - Basic principle - different types - variable reluctance, permanent magnet, hybrid type - principle of operation – comparison. Monofilar and bifilar windings - modes of excitation- static and dynamic characteristics- open loop and closed loop control of Stepper Motor-applications.

Module 3 (7 hours)

Synchronous Reluctance Motor - Construction, principle of operation- phasor diagram - torque equation - applications.

Switched reluctance motors - principle of operation - torque equation – characteristics - power converter circuits - control of SRM - rotor position sensors- torque pulsations – sources of noise- noise mitigation techniques - applications.

Module 4 (6 hours)

DC Servo motors – DC servo motors – construction– principle of operation - transfer function of field and armature controlled dc servo motors -permanent magnet armature controlled dc servo motor- series split field dc servo motor- applications.

AC Servo motors -Construction – principle of operation- performance characteristics - damped ac servo motors - Drag cup servo motors- applications.

Module 5 (8 hours)

Single Phase Special Electrical Machines- AC series Motor, Repulsion Motor, Hysteresis Motor, Universal Motor- Construction - principle of operation - applications.

Linear Electric Machines: Linear motors – different types – linear reluctance motor- linear synchronous motors – construction – comparison.

Linear Induction Motor – Construction- Thrust Equation, Transverse edge and end effects- Equivalent Circuit, Thrust-Speed characteristics, Applications.

Text Book:

1. E. G. Janardhanan, '*Special Electrical Machines*' PHI Learning Private Limited.

References:

1. R. Krishnan, '*Permanent magnet synchronous and Brushless DC motor Drives*', CRC Press.
2. T. J. E. Miller, '*Brushless PM and Reluctance Motor Drives*', C. Larendon Press, Oxford.
3. Theodore Wildi, '*Electric Machines, Drives and Power Systems*', Prentice Hall India Ltd.
4. Veinott & Martin, '*Fractional & Sub-fractional hp Electric Motors*', McGraw Hill International Edn.
5. R. Krishnan, '*Switched Reluctance Motor Drives*', CRC Press.
6. K. Venkataratnam, '*Special Electrical Machines*', Universities Press.

Course Contents and Lecture Schedule

No.	Topic	No. of Lectures
1	Permanent Magnet DC Motors (8 hours)	
1.1	Permanent Magnet DC Motors – construction – principle of operation.	1
1.2	Brushless DC motor-construction - permanent magnets – different types-demagnetization characteristics	1
1.3	Arrangement of permanent magnets – magnetization of permanent magnets – axial and parallel magnetizations- principle of operation	2
1.4	Control of BLDC motor- applications.	1
1.6	Permanent Magnet Synchronous Motors-construction- principle of operation	1
1.7	Control methods of PMSM-Self control- Sensorless Control -applications- Comparison with BLDC	2
2	Stepper motors (7 hours)	
2.1	Stepper motors – construction and principle of operation	1
2.2	different types - variable reluctance , permanent magnet, hybrid type - principle of operation – comparison	2
2.3	Windings - Monofilar and bifilar windings- modes of excitation- Full step on mode, two phase ON mode, Half step mode.	2
2.4	Static and dynamic characteristics	1
2.5	Open loop and closed loop control of Stepper Motor-applications.	1
3	Reluctance motors (7 Hours)	
3.1	Synchronous Reluctance Motor - Construction, principle of operation	1
3.2	Phasor diagram - torque equation- torque-slip characteristics- applications	2
3.3	Switched reluctance motors - principle of operation - torque equation-characteristics - power converter circuits .	2
3.4	Control of SRM - rotor position sensors-	1
3.5	Torque pulsations – sources of noise- mitigation techniques -	1

	applications.	
4	Servo motors (6 Hours)	
4.1	DC servo motors – construction– principle of operation - transfer function of field and armature controlled DC servomotors	2
4.2	Permanent magnet armature controlled - series split field DC servo motor- applications	2
4.3	AC Servomotors -Construction – principle of operation- performance characteristics	1
4.4	Damped AC servo motors - Drag cup servo motors- applications.	1
5	Single Phase Special Electrical Machines- (8 Hours)	
5.1	AC series Motor, Repulsion Motor, Hysteresis Motor, Universal Motor- Construction -principle of operation - applications.	3
5.2	Linear Electric Machines: Linear motors – different types	1
5.3	Linear reluctance motor , linear synchronous motors – construction – comparison.	1
5.4	Linear Induction Motor – Construction- Thrust Equation, Transverse edge and end effects	2
5.5	Equivalent Circuit, Thrust-Speed characteristics, Applications.	1

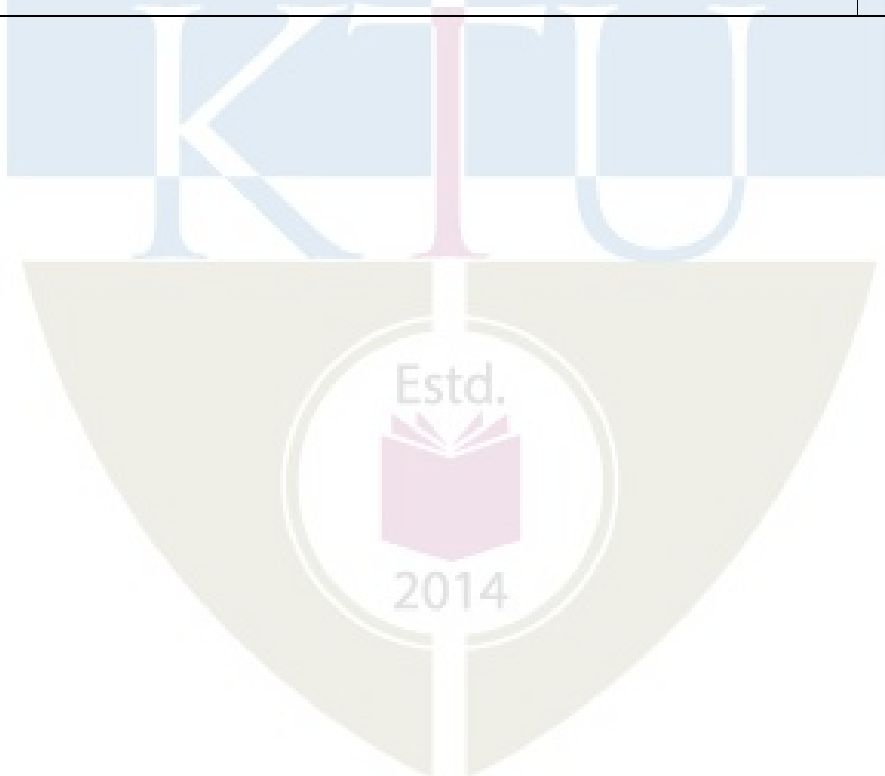

CODE	COURSE NAME	CATEGORY	L	T	P	CREDIT
EET436	POWER QUALITY	PEC	2	1	0	3

Preamble: The objective of this course is to introduce the fundamental concepts of power quality. This course covers different power quality issues and its mitigation methods.

Prerequisite: Nil

Course Outcomes: After the completion of the course the student will be able to

CO 1	Identify the sources and effects of power quality problems.
CO 2	Apply Fourier concepts for harmonic analysis.
CO 3	Explain the important aspects of power quality monitoring.
CO 4	Examine power quality mitigation techniques.
CO 5	Discuss power quality issues in grid connected renewable energy systems.

Mapping of course outcomes with program outcomes

	PO 1	PO 2	PO 3	PO 4	PO 5	PO 6	PO 7	PO 8	PO 9	PO 10	PO 11	PO 12
CO 1	3	2	-	-	-	2	-	1	-	-	-	2
CO 2	3	3	-	-	-	-	-	-	-	-	-	2
CO 3	3	3	-	-	3	-	-	-	-	-	-	2
CO 4	3	3	2	-	-	-	-	1	-	-	-	2
CO 5	3	2	-	-	-	-	-	-	-	-	-	2

Assessment Pattern

Bloom's Category	Continuous Assessment Tests		End Semester Examination
	1	2	
Remember	20	20	40
Understand	20	20	40
Apply	10	10	20
Analyse			
Evaluate			
Create			

Mark distribution

Total Marks	CIE	ESE	ESE Duration
150	50	100	3 hours

Continuous Internal Evaluation Pattern:

Attendance : 10 marks

Continuous Assessment Test (2 numbers) : 25 marks

Assignment/Quiz/Course project : 15 marks

End Semester Examination Pattern: There will be two parts; Part A and Part B. Part A contain 10 questions with 2 questions from each module, having 3 marks for each question. Students should answer all questions. Part B contains 2 questions from each module of which student should answer any one. Each question can have maximum 2 sub-divisions and carry 14 marks.

Course Level Assessment Questions**Course Outcome 1 (CO1):**

1. What is meant by Power Quality? (K2, PO1, PO2, PO8)
2. Explain the sources and effects of different power quality problems. (K1, PO1, PO2, PO6, PO12)
3. Discuss the different types of power quality disturbances. (K1, PO1, PO2, PO12)

Course Outcome 2 (CO2)

1. Discuss the important sources of harmonics in the power network. (K1, PO1, PO2, PO12)
2. What are the effects of harmonics in the power system and other networks? (K2, PO1, PO2, PO12)
3. Conduct harmonic analysis using suitable methods. (K3, PO1, PO2)

Course Outcome 3(CO3):

1. Explain the important indices used to quantify harmonics in a power network? (K2, PO1, PO2)
2. Describe the key aspects of different power quality standards. (K2, PO1, PO2, PO12)
3. Discuss the objectives, features and measurement issues of different monitoring instruments. (K2, PO1, PO2, PO5, PO12)

Course Outcome 4 (CO4):

1. Design passive filters for mitigating harmonic distortion. (K3, PO1, PO2, PO3, PO8, PO12)

2. Discuss the important active filters used for harmonic suppression and sag/swell correction. (K2, PO1, PO2, PO12)
3. Explain the operation of a single phase active power factor converter. (K2, PO1, PO2)

Course Outcome 5 (CO5):

1. Discuss the configuration and working of shunt and series-shunt power quality conditioners. (K2, PO1, PO2)
2. Identify the important power quality issues associated with grid connected renewable energy systems. (K2, PO1, PO2, PO12)
3. Explain the operating conflicts in connection with grid connected renewable energy system. (K2, PO1, PO2, PO12)
4. Discuss the problems and its solutions associated with wiring and grounding. (K2, PO1, PO2, PO12)

Model Question Paper

QP CODE:

PAGES:2

Reg.No: _____

Name: _____

**APJ ABDUL KALAM TECHNOLOGICAL UNIVERSITY
EIGHTH SEMESTER B.TECH DEGREE EXAMINATION,
MONTH & YEAR**

Course Code: EET436

Course Name: POWER QUALITY

Max. Marks: 100

Duration: 3 Hrs

PART A

Answer all questions. Each Question Carries 3 marks

1. 'Power Quality is voltage quality'. Comment.
2. Differentiate between impulsive and oscillatory transients.
3. What do you mean by triplen harmonics and what are its effects in the power system?
4. Explain the generation of harmonics in the presence of non-linear loads.
5. Write short note on IEEE 519 standard.
6. Discuss the objectives of power quality monitoring.
7. List the merits and demerits of passive filters to reduce harmonic distortion.
8. Define Telephone Interference Factor.
9. What is meant by islanding? List the problems caused by it.
10. Describe the term Ground Loops. List solutions for mitigating this problem.

PART B

Answer any one full question from each module. Each question carries 14 marks.

Module 1

11. a) Explain the sources of voltage sag in a power network. (6)
 b) Discuss any four effects of power quality problems. (8)
12. What is meant by waveform distortions? Using neat diagrams, explain the five primary types of waveform distortion. (14)

Module 2

13. Explain the effects of power system harmonics on different components of power systems. (14)
14. For a quasi-square wave of (120° pulse width) of current with an amplitude I of 100A (shown in Fig), calculate (a) crest factor (CF), (b) distortion factor (DF), and (c) total harmonic distortion. (14)

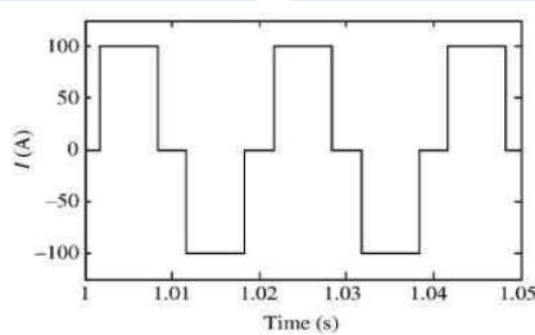
**Module 3**

15. a) Define total harmonic distortion, distortion factor, total demand distortion and telephone influence factor. (8)
 b) Derive the relationship between total power factor, distortion factor and displacement factor. (6)
16. a) How is RMS value computed by a power quality monitoring instrument? (7)
 b) Describe the functionalities offered by a power quality analyzer. (7)

Module 4

17. a) Explain the working principle of DVR for sag and swell correction. (6)
 b) A single-phase fully controlled bridge converter is fed from a supply of 230V at 50 Hz at a thyristor firing angle of 60° . Consider continuous load current of 200 A. Design a shunt passive filter with third, fifth, seventh and a ninth passive tuned filters. (8)
18. Draw the configuration of a unified power quality conditioner and show that it offers a single solution for mitigating multiple power quality problems. (14)

Module 5

19. Explain the operation of a PWM power factor correction circuit. Using a block diagram, explain the control logic of the same. (14)
20. Discuss the important solutions to wiring and grounding problems. (14)

Syllabus**Module 1 (6 hours)**

Power quality phenomenon - Sources and effects of power quality problems, Need for concern of Power quality, types of power quality disturbances – Transients – classification and origin, Short duration voltage variation – interruption, sag, swell, Long duration voltage variation, voltage unbalance, waveform distortion - notching, harmonics and voltage flicker

Module 2 (8 hours)

Harmonics - mechanism of harmonic generation, Triplen harmonics, Harmonic sources – switching devices, arcing devices and saturable devices, Effects of harmonics on power system equipment and loads – transformers, capacitor banks, motors and telecommunication systems, Effect of triplen harmonics on neutral current, line and phase voltages.

Harmonic analysis using Fourier series and Fourier transforms – simple numerical problems

Module 3 (6 hours)

Harmonic indices (CF, DF, THD, TDD, TIF, DIN, C – message weights), Displacement and total power factor

Overview of power quality standards: IEEE 519, IEEE 1433 and IEC 61000

Power quality Monitoring: Objectives and measurement issues, different monitoring instruments – Power quality analyzer, harmonic spectrum analyzer, flicker meters

Module 4 (6 hours)

Mitigation of Power quality problems - Harmonic elimination - Design simple problems and analysis of passive filters to reduce harmonic distortion – demerits of passive filters – description of active filters - shunt, series, hybrid filters, sag and swell correction using DVR

Power quality conditioners - DSTATCOM and UPQC - Configuration and working

Module 5**(6 hours)**

Power factor correction – Single phase active power factor converter – circuit schematic and control block diagram

Power Quality issues of Grid connected Renewable Energy Systems – operating conflicts

Grounding and wiring– reasons for grounding – wiring and grounding problems - solutions to these problems

Note: It is encouraged to conduct assignments involving case studies to get hands-on experience of use of power quality instruments for power quality monitoring.

Text/Reference Books

1. R. C. Dugan, M. F. Me Granaghan, H. W. Beaty, '*Electrical Power System Quality*', McGraw-Hill, 2012
2. Angelo Baggini (Ed.) *Handbook of Power Quality*, Wiley, 2008
3. C. Sankaran, '*Power Quality*', CRC Press, 2002
4. G. T. Heydt, '*Power Quality*', Stars in circle publication, Indiana, 1991
5. Jose Arillaga, Neville R. Watson, '*Power System Harmonics*', Wiley, 1997
6. Math H. Bollen, '*Understanding Power Quality Problems*' Wiley-IEEE Press, 1999
7. Bhim Singh, Ambrish Chandra and Kamal Al-Haddad, "Power Quality problems and mitigation techniques", John Wiley and Sons Ltd, 2015.
8. Surajit Chattopadhyay, 'Electric power quality' – Springer, 2011

Course Contents and Lecture Schedule

No	Topic	No. of Lectures (32 Hours)
1	Power quality phenomenon	6
1.1	Sources and effects of power quality problems	1
1.2	Need for concern of Power quality	1
1.3	Types of power quality disturbances – Transients – classification and origin	1
1.4	Short duration voltage variation – interruption, sag, swell	1
1.5	Long duration voltage variation, voltage unbalance	1
1.6	Waveform distortion - notching, harmonics and voltage flicker	1
2	Harmonics	8
2.1	Mechanism of harmonic generation	1
2.2	Harmonic sources – switching devices, arcing devices and saturable devices	1
2.3	Effects of harmonics on power system equipment and loads –	2

	transformers, capacitor banks, motors and telecommunication systems	
2.4	Effect of triplen harmonics on neutral current, line and phase voltages.	1
2.5	Harmonic analysis using Fourier series and Fourier transforms simple numerical problems	3
3	Harmonic indices, PQ standard and monitoring	6
3.1	Harmonic indices - CF, DF, THD, TDD, TIF	1
3.2	Harmonic indices - DIN, C – message weights, Displacement and total power factor	1
3.3	Overview of power quality standards: IEEE 519, IEEE 1433 and IEC 61000	2
3.4	Power quality Monitoring: Objectives and measurement issues	1
3.5	Different monitoring instruments – Power quality analyzer, harmonic spectrum analyzer, flicker meters	1
4	Mitigation of Power quality problems and Power factor correction	6
4.1	Harmonic elimination – Design of passive filters simple problems	1
4.2	Analysis of passive filters	1
4.3	Demerits of passive filters –description of active filters - shunt, series, hybrid filters	1
4.4	Sag and swell correction using DVR	1
4.5	DSTATCOM and UPQC - Configuration and working	2
5	Power quality conditioners, PQ in Grid connected RE systems, Grounding & Wiring	6
5.1	Power factor correction – Single phase active power factor converter – circuit schematic and control block diagram	1
5.2	Power Quality issues of Grid connected Renewable Energy Systems	1
5.3	Operating conflicts	1
5.4	Grounding and wiring– reasons for grounding	1
5.5	Wiring and grounding problems - solutions to these problems	2

Assessment Pattern

Bloom's Category	Continuous Assessment Tests		End Semester Examination
	1	2	
Remember	15	15	30
Understand	25	25	50
Apply	10	10	20
Analyse			
Evaluate			
Create			

Mark Distribution

Total Marks	CIE Marks	ESE Marks	ESE Duration
150	50	100	3

Continuous Internal Evaluation Pattern:

Attendance : 10 marks
 Continuous Assessment Test : 25 marks
 Continuous Assessment Assignment : 15 marks

End Semester Examination Pattern:

End Semester Examination Pattern: There will be two parts; Part A and Part B. Part A contain 10 questions with 2 questions from each module, having 3 marks for each question. Students should answer all questions. Part B contains 2 questions from each module of which student should answer any one. Each question can have maximum 2 sub-divisions and carry 14 marks.

Course Level Assessment Questions**Course outcome 1 (CO1) :**

1. Compare the OSI and TCP/IP reference model (K2, PO1).
2. Distinguish between Connection oriented and connectionless service (K3, PO1).
3. Explain various performance indicators of computer networks. (K2,PO1)

Course outcome 2 (CO2) :

1. Explain the role of the Data link layer in computer networks. (K2, PO1)
2. Discuss the sliding window protocol for error detection and correction (K2, PO1, PO2).
3. Explain the use of Switches, Routers and Gateways (K2,PO1).

Course outcome 3 (CO3) :

1. What is flooding? (K1, PO1)
2. Explain various routing algorithms (Any one algorithm may be asked) (K2, PO1,PO2)
3. Discuss how congestion control is done in computer networks. (K2, PO1, PO2)
4. What is meant by Quality of service? How can it be improved? (K1, PO1)
5. Compare the performance of various routing algorithms (K3,PO1).

Course outcome 4 (CO4) :

1. Describe the format of IPv4/IPv6 datagram with the help of a diagram, highlighting the significance of each field. (any one may be asked only). (K2, PO1)
2. Explain Subnetting with an example. (K2, PO1)
3. What is the advantage of using DHCP? (K1, PO1)
4. Explain Open Shortest Path First (OSPF) Protocol and Border Gateway Protocol (BGP). (Any one may be asked as a part question) (K2,PO1)

Course outcome 5 (CO5) :

1. Explain the UDP/TCP protocol. (K2,PO1)
2. What is RPC? (K1,PO1)
3. What is the use of DNS? (K1,PO1)
4. Explain how message transfer is done using SMTP. (K2,PO1)
5. Discuss the security issues of FTP. How can it be improved? (K2,PO1)



Model Question Paper**QP CODE:****PAGES:** ____**Reg No:** _____**Name:** _____**APJ ABDUL KALAM TECHNOLOGICAL UNIVERSITY****EIGHTH SEMESTER B.TECH DEGREE EXAMINATION, MONTH & YEAR****Course Code: EET446****Course Name : Computer Networks****Max Marks: 100****Duration: 3 Hours****PART-A****(Answer All Questions. Each question carries 3 marks)**

1.	What is a VPN ?	(10x3= 30 Marks)
2.	Discuss why fiber optic is preferred over copper wires, when you want to get higher bandwidth in the range of 100Mbps or higher.	
3.	What is the need for framing?	
4.	What is piggybacking ?	
5.	Compare adaptive routing algorithms with the non-adaptive type.	
6.	What is jitter and discuss how it can affect various data transfer applications.	
7.	What is the urgent need for migrating to IPv6 from IPv4?	
8.	Discuss ARP.	
9.	What is the use of DNS?	
10.	What is FTP and discuss its security concerns.	
PART-B		
(Answer any one Questions. Each question carries 14 marks)		
11.	“Most networks are organized as a stack of layers or levels, each one built upon the one below it”. Comment on why a layered approach is adopted with reference to the OSI and TCP/IP reference models.	14
OR		

12.	a	Distinguish between Connection-Oriented and Connectionless Service	7
	b	Explain the terms Bandwidth, Throughput, Latency, Bandwidth–Delay product.	7
13.		Suppose your organization is spread over 5 buildings in a 100 acre campus, and you are asked to set up an intranet with net connectivity. Discuss how you will set up the network highlighting the use of suitable physical media and various networking devices. A rough architecture diagram is expected.	14
OR			
14.		Explain CSMA/CD with reference to classic Ethernet LAN,	14
15.		Explain Link state routing.	14
OR			
16.		Discuss the various means by which congestion control can be achieved.	14
17.		Describe the format of IPv4 datagram with the help of a diagram, highlighting the significance of each field.	14
OR			
18.		Define Subnetting. What are the advantages of Subnetting? Explain with an example	14
19.		Compare TCP with UDP.	14
OR			
20.		Explain how message transfer is done using SMTP.	14

Syllabus

Module - 1 (Introduction and Physical Layer)

Introduction – Uses of computer networks, Network hardware, Network software - Protocol hierarchies – Design issues for the layers – Connection oriented versus connectionless service. Reference models – The OSI reference model, The TCP/IP reference model, Comparison of OSI and TCP/IP reference models.

Physical Layer –Transmission media overview – Twisted pair and fiber optics. Performance indicators – Bandwidth, Throughput, Latency, Bandwidth–Delay product.

Module - 2 (Data Link Layer)

Data link layer - Data link layer design issues, Error detection and correction, Sliding window protocols.

Medium Access Control (MAC) sublayer, Channel allocation problem, Multiple access protocols – CSMA, Collision free protocols.

Ethernet – Switched Ethernet, fast Ethernet and gigabit Ethernet.

Wireless LANs - 802.11 – Architecture and protocol stack, Use of Bridges, Repeaters, Hubs, Switches, Routers and Gateways.

Module - 3 (Network Layer)

Network layer design issues. Routing algorithms - The Optimality Principle, Shortest path routing, Flooding, Distance Vector Routing, Link State Routing, Routing for mobile hosts.

Congestion control algorithms – Approaches to congestion control (Details not required).

Quality of Service (QoS) - Requirements, Techniques for achieving good QoS – Traffic shaping, Packet scheduling.

Module - 4 (Network Layer in the Internet)

IPv4 protocol, IP addresses, IPv6, Internet Control Protocols - Internet Control Message Protocol (ICMP), Address Resolution Protocol (ARP), Dynamic Host Configuration Protocol (DHCP). Open Shortest Path First (OSPF) Protocol, Border Gateway Protocol (BGP), Internet multicasting.

Module – 5 (Transport Layer and Application Layer)

Transport service – Services provided to the upper layers, Transport service primitives. User Datagram Protocol (UDP) – Introduction, Remote procedure call.

Transmission Control Protocol (TCP) – Introduction, TCP service model, TCP protocol, TCP segment header, Connection establishment & release.

Application Layer –Domain Name System (DNS) – overview of DNS name space and Name servers, Electronic mail – Architecture and services- SMTP – IMAP - POP3, World Wide Web (WWW) - Architectural overview, HTTP, File Transfer Protocol (FTP).

Text Book

1. Andrew S. Tanenbaum, Computer Networks, 5/e, Pearson Education India.
2. Behrouz A Forouzan, Data Communication and Networking, 5/e, McGraw Hill Education

Reference Books

1. Larry L Peterson and Bruce S Dave, Computer Networks – A Systems Approach, 5/e, Morgan Kaufmann.
2. Fred Halsall, Computer Networking and the Internet, 5/e.
3. James F. Kurose, Keith W. Ross, Computer Networking: A Top-Down Approach, 6/e.
4. Keshav, An Engineering Approach to Computer Networks, Addison Wesley, 1998.
5. W. Richard Stevens. TCP/IP Illustrated Volume 1, Addison-Wesley, 2005.
6. William Stallings, Computer Networking with Internet Protocols, Prentice-Hall, 2004.

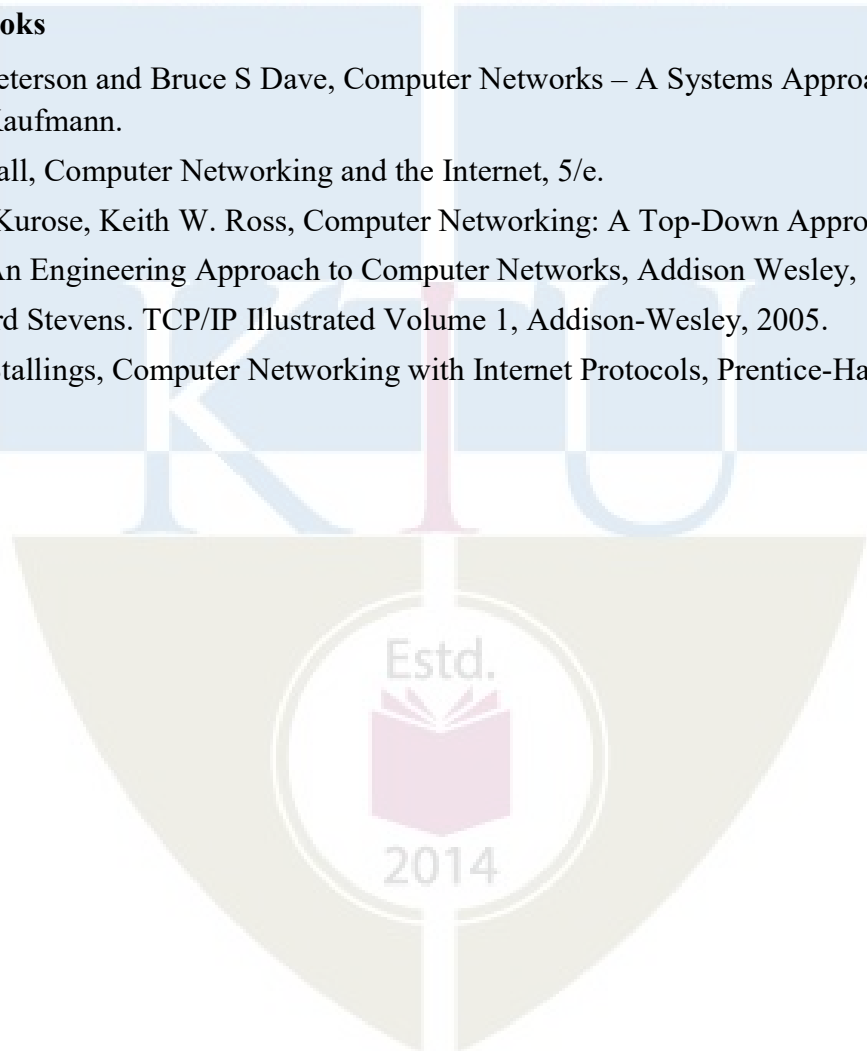

Course Contents and Lecture Schedule

No	Contents	No of Lecture Hrs
Module – 1 (Introduction and Physical Layer) (7 hrs)		
1.1	Introduction – Uses of computer networks	1
1.2	Uses of computer networks, Network hardware	1
1.3	Network software - Protocol hierarchies – Design issues for the layers – Connection oriented versus connectionless service.	1
1.4	Reference models – The OSI reference model, The TCP/IP reference model	1
1.5	Reference models, Comparison of OSI and TCP/IP reference models.	1
1.6	Physical Layer – Transmission media overview – Twisted pair and fiber optics.	1
1.7	Performance indicators – Bandwidth, Throughput, Latency, Bandwidth–Delay product.	1
Module 2 – (Data Link Layer) (8 hrs)		
2.1	Data link layer - Data link layer design issues	1
2.2	Error detection and correction	1
2.3	Sliding window protocols.	1
2.4	Sliding window protocols, Medium Access Control (MAC) sublayer.	1
2.5	Channel allocation problem, Multiple access protocols – CSMA	1
2.6	Collision free protocols.	1
2.7	Ethernet – Switched Ethernet, fast Ethernet and gigabit Ethernet. Wireless LANs - 802.11 – Architecture and protocol stack	1

2.8	Use of Bridges, Repeaters, Hubs, Switches, Routers and Gateways.	1
Module 3 - (Network Layer) (6 hrs)		
3.1	Network layer design issues.	1
3.2	Routing algorithms, The Optimality Principle, Shortest path routing, Flooding.	1
3.3	Distance Vector Routing.	1
3.4	Link State Routing.	1
3.5	Routing for mobile hosts, Congestion control algorithms – Approaches to congestion control (Details not required).	1
3.6	Quality of Service (QoS) - Requirements, Techniques for achieving good QoS – Traffic shaping, Packet scheduling.	1
Module 4 – (Network Layer in the Internet) (7 hrs)		
4.1	Internet Protocol (IP) - IPv4 protocol	1
4.2	IP addresses.	1
4.3	IP addresses – part 2	1
4.4	IPv6	1
4.5	Internet Control Protocols - Internet Control Message Protocol (ICMP), Address Resolution Protocol (ARP), Dynamic Host Configuration Protocol (DHCP).	1
4.6	Open Shortest Path First (OSPF) Protocol.	1
4.7	Border Gateway Protocol (BGP), Internet multicasting.	1
Module 5 - (Transport Layer and Application Layer) (7 hrs)		
5.1	Transport service – Services provided to the upper layers Transport service primitives.	1
5.2	User Datagram Protocol (UDP) – Introduction, Remote procedure call.	1
5.3	Transmission Control Protocol (TCP) – Introduction, TCP	1

	service model, TCP protocol	
5.4	TCP segment header, Connection establishment & release.	1
5.5	Application Layer –Domain Name System (DNS) – overview of DNS name space and Name servers	1
5.6	Electronic mail – Architecture and services- SMTP – IMAP - POP3	1
5.7	World Wide Web (WWW) - Architectural overview, HTTP, File Transfer Protocol (FTP).	1

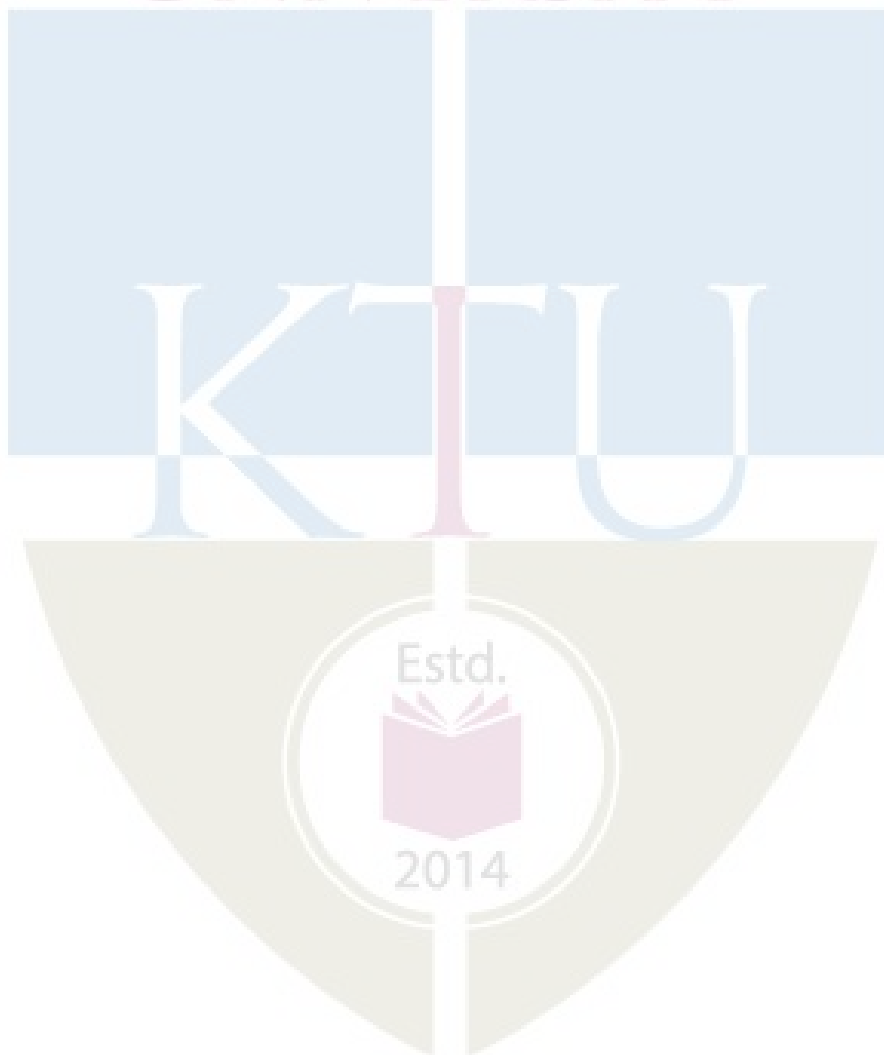

CODE	COURSE NAME	CATEGORY	L	T	P	CREDITS
EET456	DESIGN OF POWER ELECTRONIC SYSTEMS	PEC	3	0	0	3

Preamble : To impart knowledge about the design and protection of power electronic systems.

Prerequisite : EET306 Power Electronics

Course Outcomes : After the completion of the course the student will be able to:

CO 1	Design gate drive circuits for various power semiconductor switches.
CO 2	Design protection circuits for various semiconductor devices.
CO 3	Select appropriate passive components for power electronic circuits.
CO 4	Design the magnetic components for power electronic circuits.
CO 5	Design signal conditioning circuits and passive filters for converters.

Mapping of course outcomes with program outcomes

	PO 1	PO 2	PO 3	PO 4	PO 5	PO 6	PO 7	PO 8	PO 9	PO 10	PO 11	PO 12
CO 1	3	2	3	2	-	-	-	-	-	-	-	2
CO 2	3	2	3	2	-	-	-	-	-	-	-	2
CO 3	3	3	-	-	-	-	-	-	-	-	-	2
CO 4	3	3	3	2	-	-	-	-	-	-	-	2
CO 5	3	2	3	2	-	-	-	-	-	-	-	2

Assessment Pattern

Bloom's Category	Continuous Assessment		End Semester Examination
	Tests		
	1	2	
Remember (K1)	10	10	20
Understand (K2)	10	10	20
Apply (K3)	20	20	50
Analyse (K4)	10	10	10
Evaluate (K5)	-	-	-
Create (K6)	-	-	-

End Semester Examination Pattern : There will be two parts; Part A and Part B. Part A contain 10 questions with 2 questions from each module, having 3 marks for each question. Students should answer all questions. Part B contains 2 questions from each module of which student should answer any one. Each question can have maximum 2 sub-divisions and carry 14 marks.

Course Level Assessment Questions

Course Outcome 1 (CO1):

1. Design a gate/base drive using totem pole arrangement (K1, K3, PO1, PO2, PO4)
2. Design a gate drive using a non-isolated circuit (K1, K3, PO1, PO2, PO4)
3. Design high side and low side switch drives using isolated gate drivers (K1, K3, PO1, PO2, PO4)
4. Explain the boot-strap technique for gate drives using gate drive IC IR 2110 (K1, K2, PO1)

Course Outcome 2 (CO2):

1. Design a turn-off and turn-on snubber circuit for SCR (K1,K3,PO1, PO2, PO4)
2. Design a Snubber circuit for a buck converter (K1, K3, PO1, PO2, PO4)
3. Describe the thermal protection, short-circuit and over-current protection in IGBTs (K1,K2, PO1)
4. Explain the steps for the design of heat sinks (K1,K2, PO1)

Course Outcome 3 (CO3):

1. Explain the different types of inductor and transformer assembly (K1, PO1)
2. Explain the types of capacitors used in power electronic circuits and their selection (K1,K2, PO1)
3. Explain the effect of equivalent series resistance and equivalent series Inductance of capacitors in converter operation (K4, PO1)
4. Explain the filter design for single phase and three phase inverters (K3, PO1, PO2)
5. Describe the various types of power resistors used in power electronic circuits (K1, PO1)

Course Outcome 4 (CO4):

1. Describe the selection of amorphous, ferrite and iron cores used in power electronic circuits(K1,K2)
2. Explain the Inductor design in power electronics circuits (K3)
3. Explain the transformer design in power electronics circuits (K3)
4. Explain the wire selection and skin effect in power electronics circuits (K1,K2)

Course Outcome 5 (CO5):

1. Explain the design of current transformers, resistive shunts, hall-effect based voltage and current sensors for power electronics circuits (K2, K3, PO1)
2. Design input and output filters for single phase and three phase inverters (K3, PO1, PO2, PO4)

3. Explain the corner frequency selection and harmonic filtering performance in inverter circuits (K2,K4, PO1)
4. Explain the various components in an Intelligent Power Module (K1,K2, PO1)

Model Question Paper

QP CODE:

PAGES:2

Reg.No: _____

Name: _____

APJ ABDUL KALAM TECHNOLOGICAL UNIVERSITY
EIGHTH SEMESTER B.TECH DEGREE EXAMINATION,
MONTH & YEAR
Course Code: EET456

Course Name: DESIGN OF POWER ELECTRONIC SYSTEMS

Max. Marks: 100

Duration: 3 Hours

PART A (3 x 10 = 30 Marks)

Answer all Questions. Each question carries 3 Marks

1. A MOSFET has an input capacitance $C_{iss} = 800 \text{ pF}$. A gate resistance of 250Ω is used along with a gate drive voltage peak of 12 V . If the threshold gate voltage is $V_{gs(th)} = 4 \text{ V}$, how long will it take this gate signal to turn on the MOSFET?
2. Design a gate drive using non-isolated and isolated circuits.
3. Design a turn-off and turn-on snubber circuit for SCR.
4. Design a Snubber circuit for a buck converter.
5. Explain the different types of inductor and transformer assembly.
6. Explain the types of capacitors used in power electronic circuits and their selection.
7. Describe the selection of amorphous, ferrite and iron cores used in power electronic circuits.
8. Explain the Inductor design in power electronics circuits.
9. Design current transformers, resistive shunts, hall-effect based voltage and current sensors for power electronics applications.
10. Design input and output filters for single phase and three phase inverters.

PART B (14 x 5 = 70 Marks)

Answer any one full question from each module. Each question carries 14 Marks

Module 1

11. a) Design high side switch drive using isolated gate drivers.

(6)

- b) Design low side switch drive using isolated gate drivers. (8)
12. a) Explain the boot-strap technique for gate drive design using gate drive IC IR 2110 (8)
- b) Design a gate drive circuit for IGBT (6)

Module 2

13. a) Describe the thermal protection in IGBTs. (10)
- b) Explain the steps for the design of heat sinks. (4)
14. a) Describe the short-circuit protection in IGBTs (7)
- b) Describe the over-current protection in IGBTs (7)

Module 3

15. a) Two capacitor values are made by a manufacturer. The two have similar size, and each has an ESL of 20 nH, and $\tan \delta=0.2$. One is 1000 μF and the other is 100 μF . Evaluate their ESRs and resonant frequencies. If 10 numbers of 100 μF capacitors are paralleled to make 1000 μF , evaluate the ESR, ESL and the resonant frequency of the paralleled combination. Which (a single 1000 μF or a parallel combination of 10 numbers of 100 μF), is better in terms of operating frequency? (10)
- b) Explain the filter design for single phase and three phase inverters (4)
16. a) Describe the various types of power resistors used in power electronic circuits. (6)
- b) Explain the effect of equivalent series resistance of capacitor (8)

Module 4

17. a) Design high frequency transformer in power electronics circuits. (8)
- b) Explain the wire selection in power electronics circuits. (6)
18. a) A 2 mH inductor design for dc applications is as follows, for a maximum current of 0.5A: Core: 26x19; $A_w = 40\text{mm}^2$, $A_C = 90\text{mm}^2$; $N=37$; $a_w = 0.29\text{mm}^2$ (23 SWG). For the above core and windings and N, evaluate the peak flux density, peak current density, window space factor (kw), and the inductance value, for air gap values of 0.08mm and 1mm. (10)
- b) Explain the thermal considerations in power electronic circuits (4)

Module 5

19. a) Explain the corner frequency selection in inverter circuits (8)
- b) Explain the various components in an Intelligent Power Module (6)
20. a) Explain the harmonic filtering performance in inverter circuits (8)
- b) Explain the methods for reducing stray inductance in power electronic circuits (6)

Syllabus

Module 1 (8 hrs)

Gate and base drive design: Gate drive requirements and gate/base drive design for SCRs, BJTs, MOSFETs, IGBTs-Gate drive design using discrete components - open collector, totem pole, non-isolated and isolated- optocoupler, pulse transformer based, use of ICs such as DS0026, TLP250- High side and low side switch driving using isolated gate drivers. Bootstrap technique for gate drives using gate drive IC IR 2110.

Major references: Ref.1, Ref.2, Ref.3

Module 2 (7 hrs)

Design of protection elements: Snubber circuits: Function and types of Snubber circuits, design of turn -off and turn-on snubber. Snubber design for step-down converter. Short-circuit and over-current protection in IGBTs, desaturation protection. Thermal protection, cooling, design and selection of heat sinks (natural cooling only).

Major references: Ref.1, Ref.2,

Module 3 (7 hrs)

Passive elements in Power electronics: Inductors: types of inductors and transformer assembly-. Capacitors: types of capacitors used in power electronic circuits, selection of capacitors, dc link capacitors in inverters, filter capacitors in dc-dc and inverter circuits, equivalent series resistance and equivalent series Inductance of capacitors and their effects in converter operation. Design of filters - input and output filters - typical filter design for single phase and three phase inverters - LC filter - corner frequency selection - harmonic filtering performance – design constraints. Resistors: power resistors, use in snubbers. Resistors for special purpose: high voltage resistors and current shunts.

Major references: Ref.1, Ref.4,

Module 4 (7 hrs)

Magnetics design: Magnetic materials and cores: amorphous, ferrite and iron cores-Inductor and transformer design based on area-product approach. Magnetic characteristics and selection based on loss performance and size, eddy current and hysteresis loss. Thermal considerations, leakage inductance, comparison of sizes of transformer and inductor, wire selection and skin effect.

Major References: Ref.1,2,3,5,6

Module 5 (7 hrs)

Measurements and signal conditioning: Design of current transformers for power electronic applications, resistive shunts, hall-effect based voltage and current sensors, typical design based on hall-effect sensors, signal conditioning circuits- level shifters, anti-aliasing

filters. Minimizing stray inductance in drive circuit, shielding and portioning of drive circuit, reduction of stray inductance in bus bar. Introduction to Intelligent Power Module.

Major References: Ref.6

Assignments/ course projects may be given based on the topic: Demonstrative design of a converter such as Buck converter/ Flyback converter.

Text/Reference Books:

1. Mohan N., T. M. Undeland and W. P. Robbins., Power Electronics, Converters, Applications & Design, Wiley-India, 2002.
2. L. Umanand, Power Electronics – Essentials & Applications, Wiley-India, 2009.
3. V. Ramanarayanan, Course material on ‘Switched mode power conversion’ 2007.
4. Daniel W. Hart, Power Electronics, Tata McGraw-Hill Education, 2011.
5. Erickson, Robert W., and Maksimovic, Dragan, Fundamentals of Power Electronics, 1997.
6. Krein P. T., Elements of Power Electronics, Oxford University Press, 1998.
7. Joseph Vithayathil, Power Electronics: Principles and Applications, McGraw-Hill College; International edition, 1995.
8. Singh M. D. and K. B. Khanchandani, Power Electronics, Tata McGraw Hill, New Delhi, 2008.
9. Muhammad H. Rashid, Power Electronics Circuits, Devices and Applications, Pearson Education, 2014.
10. P.S. Bimbhra, Power Electronics, Khanna Publishers, New Delhi, 1990.

Course Contents and Lecture Schedule:

No.	Topic	No. of Lectures
1	Design of gate and base drive circuits (8 hours)	
1.1	Gate drive requirements and gate drive design for SCRs, BJTs, MOSFETs, IGBTs.	3
1.2	Gate drive design using discrete components	3
1.3	High side and low side switch driving using isolated gate drivers	1
1.4	Boot-strap technique for gate drives using gate drive IC IR 2110	1
2	Design of protection elements (7 hours)	
2.1	Snubber circuits: Function and types of Snubber circuits, design of turn off and turn-on snubber.	2
2.2	Snubber design for step-down converter.	2
2.3	Short-circuit and over-current protection in IGBTs, desaturation	1

	protection.	
2.4	Thermal protection, cooling, design and selection of heat sink (natural cooling only).	2
3	Passive elements in Power electronics (7 Hours)	
3.1	Inductors: types of inductors and transformer assembly	1
3.2	Capacitors: types of capacitors used in power electronic circuits, selection of capacitors	1
3.3	DC link capacitors in inverters, filter capacitors in dc-dc and inverter circuits, equivalent series resistance and equivalent series Inductance of capacitors and their effects in converter operation.	2
3.4	Design of filters: input and output filters - typical filter design for single phase and three phase inverters - LC filter - corner frequency selection - harmonic filtering performance – design constraints.	2
3.5	Resistors: power resistors, their use in snubbers. Resistors for special purpose: high voltage resistors and current shunts.	1
4	Magnetics design (7 Hours)	
4.1	Magnetic materials and cores: amorphous, ferrite and iron cores	1
4.2	Inductor and transformer design based on area-product approach	3
4.3	Magnetic characteristics and selection based on loss performance and size, eddy current and hysteresis loss	1
4.4	Thermal considerations, leakage inductance, comparison of sizes of transformer and inductor, wire selection and skin effect	2
5	Measurements and signal conditioning (7 Hours)	
5.1	Design of current transformers for power electronic applications, resistive shunts	2
5.2	Hall-effect based voltage and current sensors, typical design based on hall-effect sensors	1
5.3	Signal conditioning circuits- level shifters, anti-aliasing filters	2
5.4	Minimizing stray inductance in drive circuit, shielding and portioning of drive circuit, reduction of stray inductance in bus bar	1
5.5	Introduction to Intelligent Power Module	1

CODE	COURSE NAME	CATEGORY	L	T	P	CREDITS
EET466	HVDC AND FACTS	PEC	2	1	0	3

Preamble: This course introduces HVDC concepts and analysis of HVDC systems. It also provides a detailed study of FACTS devices.

Prerequisite : Nil

Course Outcomes : After the completion of the course the student will be able to:

CO 1	Analyse current source and voltage source converters for HVDC systems
CO 2	Describe the control schemes for HVDC systems
CO 3	Explain the need for FACTS devices
CO 4	Classify reactive power compensators in power system
CO 5	Interpret series and shunt connected FACTS devices for power system applications
CO 6	Explain the dynamic interconnection mechanisms of FACTS devices

Mapping of course outcomes with program outcomes

	PO 1	PO 2	PO 3	PO 4	PO 5	PO 6	PO 7	PO 8	PO 9	PO 10	PO 11	PO 12
CO 1	3	3			2							
CO 2	3	3			2							
CO 3	3	3			2							
CO 4	3	3			2							
CO 5	3	3			2							
CO 6	3	3			2							

Assessment Pattern

Bloom's Category	Continuous Assessment Tests		End Semester Examination
	1	2	
Remember (K1)	20	20	40
Understand (K2)	20	20	40
Apply (K3)	10	10	20
Analyse (K4)	-	-	-
Evaluate (K5)	-	-	-
Create (K6)	-	-	-

End Semester Examination Pattern : There will be two parts; Part A and Part B. Part A contain 10 questions with 2 questions from each module, having 3 marks for each question. Students should answer all questions. Part B contains 2 questions from each module of which student should answer any one. Each question can have maximum 2 sub-divisions and carry 14 marks.

Course Level Assessment Questions

Course Outcome 1 (CO1):

1. Discuss the advantages of HVDC over HVAC (K2, PO1)
2. Explain various types of HVDC system (K2, PO1)
3. Explain various converters in HVDC system(K2, PO2)

Course Outcome 2 (CO2):

1. Discuss the control basics of two terminal link (K2, PO1)
2. Explain static V_d-I_d characteristics of a HVDC system (K2, PO1)
3. Derive equivalent circuit of a two terminal HVDC link (K3, PO2)

Course Outcome 3 (CO3):

1. What is meant by voltage regulation? (K1,PO1, PO2)
2. With neat diagrams explain the effect of phase angle compensation (K2,PO1,PO2)

Course Outcome 4 (CO4):

1. Explain the principle of TSC. Also explain the effect of initial charge of the capacitor in TSC. (K2, PO1, PO2)
2. Explain the principle and operation of STATCOM(K2, PO1, PO2)

Course Outcome 5 (CO5):

1. Explain with a neat circuit and necessary waveforms, the operation of IPFC. (K2, PO1,PO2)
2. Explain the applications UPFC (K2, PO1)

Model Question Paper**QP CODE:**

PAGES: 2

Reg. .No: _____

Name: _____

**APJ ABDUL KALAM TECHNOLOGICAL UNIVERSITY
EIGHTH SEMESTER B. TECH DEGREE EXAMINATION,
MONTH & YEAR**

Course Code: EET466

Course Name: HVDC AND FACTS

Max. Marks: 100

Duration: 3 Hours

PART A (3 x 10 = 30 Marks)

Answer all Questions. Each question carries 3 Marks

1. Explain the advantages of HVDC transmission system over HVAC.
2. What will be the effect on the Short Circuit MVA of a bus if an additional HVDC line is connected to that bus?
3. Enumerate the functions of HVDC control.
4. Discuss any one method for extinction angle control in HVDC.
5. Why are FACTS controllers needed in AC power transmission systems?
6. Explain the effect of series compensation
7. Explain TSR controller with necessary waveforms
8. Explain with neat circuit and necessary waveforms, the operation of TSSC
9. Give the comparisons between UPFC and IPFC
10. Explain the working principle of Thyristor Controlled phase angle Regulator

PART B (14 x 5 = 70 Marks)

Answer any one full question from each module. Each question carries 14 Marks

Module 1

11. a) Derive average output voltage of a 6 pulse converter with overlap **(10)**
b) Compare CSC and VSC. **(4)**
12. a) Explain VSC with AC voltage control with the help of schematic. **(10)**
b) Discuss the effect of delay angle in the reactive power requirement, in a HVDC system. **(4)**

Module 2

- 13 a) Derive equivalent circuit of a two terminal HVDC link (10)
 b) Explain the hierarchy of controls in HVDC system. (4)
- 14 a) Explain static V_d-I_d characteristics of a HVDC system. (10)
 b) Draw the schematic of current control at the rectifier end. (4)

Module 3

- 15 a) Explain the effect of shunt compensation with neat diagrams (8)
 b) Give the comparisons between series and shunt compensators (6)
- 16 a) What is meant by power quality and voltage regulation?
 Explain its significance in power systems (10)
- b) List out different types of FACTS controllers. (4)

Module 4

17. Explain TCR controller. What are the different methods to eliminate harmonics? (14)
18. (a) Explain the principle and operation of SSSC compensation (4)
 (b) Explain with diagrams, the different modes of TCSC controller (10)

Module 5

- 19.a) With neat diagram, explain the modes of operation of UPFC (8)
 b) Explain with neat circuit, the operation of IPFC (6)
- 20.a) Explain the working principle of Thyristor Controlled Voltage e Regulator (4)
 b) Explain the independent reactive power flow control (P&Q) characteristic of UPFC (10)



Syllabus

Module 1

Introduction to HVDC System

Comparison of AC and DC Transmission - Types of HVDC system - Current Source Converters - Analysis without and with overlap period. Voltage Source Converters (VSC) - VSC with AC current control and VSC with AC voltage control

Module 2

HVDC Controls - Functions of HVDC Controls - Equivalent circuit for a two terminal DC Link - Control Basics for a two terminal DC Link - Current Margin Control Method - Current Control at the Rectifier - Inverter Extinction Angle Control - Hierarchy of Controls

Module 3

Introduction to FACTS

Power flow in Power Systems – Voltage regulation and reactive power flow control in Power Systems - Power flow control -Constraints of maximum transmission line loading - Needs and emergence of FACTS - Types of FACTS controllers-Advantages and disadvantages

Transmission line compensation- Uncompensated line -shunt compensation - Series compensation -Phase angle control.

Module 4

Shunt and Series Facts Devices

Static shunt Compensator - Objectives of shunt compensations - Variable impedance type VAR Generators -TCR, TSR, TSC, FC-TCR (Principle of operation and schematic) and -STATCOM (Principle of operation and schematic).

Static Series compensator - Objectives of series compensations-Variable impedance type series compensators - GCSC. TCSC, TSSC (Principle of operation and schematic)

Switching converter type Series Compensators-(SSSC) (Principle of operation and schematic)

Module 5

UPFC AND IPFC

Unified Power Flow Controller: Circuit Arrangement, Operation of UPFC- Basic principle of P and Q control- independent real and reactive power flow control- Applications

Introduction to interline power flow controller (IPFC) (Principle of operation and schematic)

Thyristor controlled Voltage and Phase angle Regulators (Principle of operation and schematic)

Note: Simulation assignments may be given in MATLAB, SCILAB, PSAT, ETAP, PSCAD, etc.

Text Books

1. Vijay K Sood, “HVDC and FACTS Controllers”, Springer, 2004
2. N.G. Hingorani and L.Gyugyi, “Understanding FACTS”, IEEE Press 2000

References:

1. K.R.Padiyar, “High Voltage DC Transmission”, Wiley 1993
2. Y.H. Song and A.T.Jones, “Flexible AC Transmission systems (FACTS)”, IEEE Press 1999.
3. K.R.Padiyar, “FACTS Controllers in Power Transmission and distribution”, New age international Publishers 2007.
4. T.J.E. Miller, “Reactive Power control in Power systems”, John Wiley 1982.
5. C.L.Wadhwa, “Electric Power Systems”, New Academic Science Limited, 1992

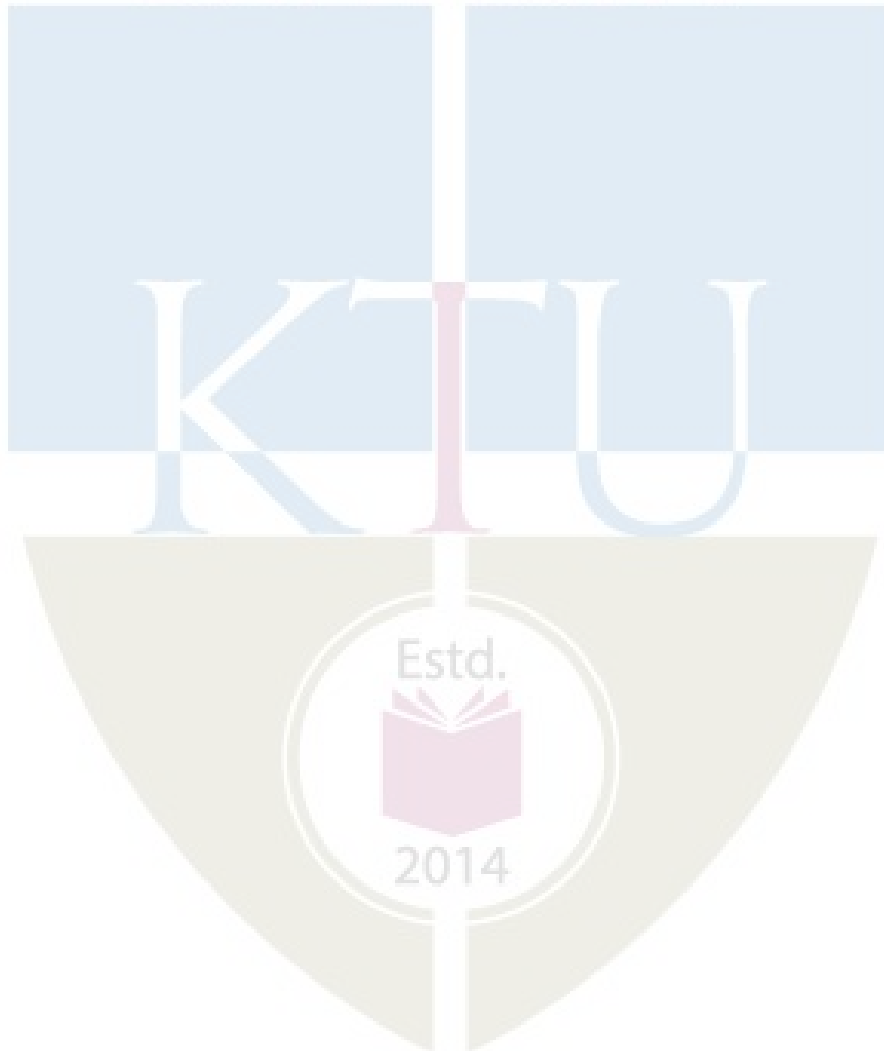

Course Contents and Lecture Schedule:

No	Topic	No. of Lectures
1	HVDC Converters(6 hours)	
1.1	Comparison of AC and DC Transmission Systems - Costs, Technical considerations and reliability	1
1.2	Types of HVDC Links	1
1.3	Current Source Converters	2
1.4	Voltage Source Converters	2
2	HVDC Controls (7 hours)	
2.1	Function of HVDC Controls	1
2.2	Control Basics of two terminal DC Link	2
2.3	Current Margin Control Method	1
2.4	Current Control at the rectifier	1
2.5	Inverter Extinction Angle Control	1
2.6	Hierarchy of Controls	1
3	Introduction to FACTS (6 hours)	
3.1	Power flow in Power Systems – Voltage regulation and reactive power flow control in Power Systems - Power flow control -Constraints of maximum transmission line loading	2
3.2	Needs, emergence of FACTS- Types of FACTS controllers-Advantages and disadvantages	2
3.3	Transmission line compensation- Uncompensated line shunt compensation - Series compensation -Phase angle control. (line diagram, vector diagram and expression for P and Q)	2
4	Shunt and Series Facts Devices (8 Hours)	
4.1	Static shunt Compensator - Objectives of shunt compensations,	1
4.2	Variable impedance type VAR Generators -TCR , TSR, TSC, FC-TCR (Principle of operation and schematic)	2
4.3	STATCOM- Principle of operation-and schematic	1

4.4	Static Series compensator - Objectives of series compensations	1
4.5	Variable impedance type series compensators - GCSC, TCSC, TSSC - Principle of operation and schematic	2
4.6	Switching converter type Series Compensators-(SSSC)- Principle of operation and schematic	1
5	UPFC AND IPFC (7 Hours)	
5.1	Unified Power Flow Controller: Circuit Arrangement, Operation of UPFC-	2
5.2	Basic principle of P and Q control- independent real and reactive power flow control- Applications	2
5.3	Introduction to interline power flow controller (IPFC).	1
5.4	Thyristor controlled Voltage and Phase angle Regulators -Principle of operation	2

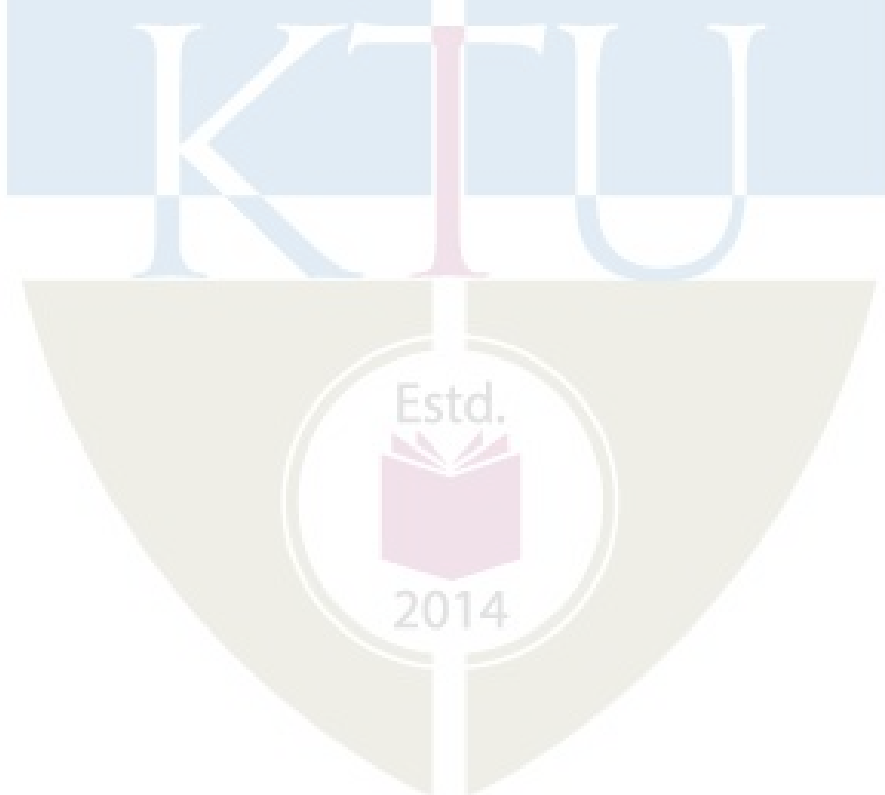

CODE	COURSE NAME	CATEGORY	L	T	P	CREDITS
EET476	ADVANCED ELECTRONIC DESIGN	PEC	2	1	0	3

Preamble: This course makes a student capable to design a system that senses a physical quantity, condition the sensed signal and digitally measure it.

Prerequisite: EET205 (Analog Electronics), EET303 (Microprocessors and microcontrollers)

Course Outcomes: After the completion of the course the student will be able to:

CO 1	Analyse the frequency response characteristics of op-amps along with its circuit properties.
CO 2	Develop advanced op-amp circuits which serve as building blocks to more complex digital and analog circuits.
CO 3	Design active filters as per situational and system demands.
CO 4	Develop sensor circuits for physical quantity measurements.
CO 5	Design the microcontroller interfacing with analog domain for real world applications.

Mapping of course outcomes with program outcomes

	PO 1	PO 2	PO 3	PO 4	PO 5	PO 6	PO 7	PO 8	PO 9	PO 10	PO 11	PO 12
CO 1	3	2	2		1							
CO 2	3	2	2	1	1							
CO 3	3	2	2	1	1							
CO 4	3	2	2	1	1							
CO 5	3	2	2	1	1							

Assessment Pattern

Bloom's Category	Continuous Assessment Tests		End Semester Examination
	1	2	
Remember	10	10	20
Understand	20	20	40

Apply	20	20	40
Analyse			
Evaluate			
Create			

Mark distribution

Total Marks	CIE	ESE	ESE Duration
150	50	100	3 hours

Continuous Internal Evaluation Pattern:

Attendance	: 10 marks
Continuous Assessment Test (2 numbers)	: 25 marks
Assignment/Quiz/Course project	: 15 marks

End Semester Examination Pattern: There will be two parts; Part A and Part B. Part A contain 10 questions with 2 questions from each module, having 3 marks for each question. Students should answer all questions. Part B contains 2 questions from each module of which student should answer any one. Each question can have a maximum 2 subdivisions and carry 14 marks.

Course Level Assessment Questions**Course Outcome 1 (CO1):**

1. Explain the frequency response characteristics of an op-amp. (K1, K2, PO1, PO2)
2. Examine the gain frequency relationships of an op-amp. (K1, K2, PO1, PO2)
3. List the non idealities in frequency response resulting in circuit applications. (K1, K2, PO1, PO4)

Course Outcome 2 (CO2)

1. Design precision rectifier circuit and voltage to current conversion circuit after mentioning the assumptions made with respect to inputs and outputs. (K3, PO1, PO2, PO4)
2. Illustrate the working of a PLL using a block diagram. (K2, PO1)
3. List the criteria you consider for designing a sample and hold circuit. (K2, PO1, PO2, PO4)

Course Outcome 3(CO3):

1. List out the benefits of an active filter over a passive filter. (K2, PO1)
2. List out the factors considered for selecting the filter order. (K2, PO1)
3. List out a set of assumptions and design a Butterworth based on your assumptions for the assumed application. (K2, PO1, PO2, PO4).

Course Outcome 4 (CO4):

1. List out the parameters you may consider for selecting a sensor for a particular application (K2, PO1, PO2, PO4).
2. Design a sensor circuit for pressure measurement with proper assumptions (K3, PO1, PO2, PO4).
3. Hall effect sensor can be termed as an isolated sensor, explain why? (K2, PO1, PO2, PO4)

Course Outcome 5 (CO5):

1. Illustrate how an LM 35 temperature sensor is interfaced with Atmega 32 with a block diagram and required coding. (K3, PO1, PO2, PO3, PO4)
2. Conduct a study on parallel vs serial ADC and list out the pros and cons. (K2, PO1, PO4).
3. Analyse the importance of conversion time of an ADC in an embedded system design. (K2, PO1, PO4).



Model Question Paper**APJ ABDUL KALAM TECHNOLOGICAL UNIVERSITY**

EIGHTH SEMESTER B.TECH DEGREE EXAMINATION,

MONTH AND YEAR

Course Code: EET476**Course Name: Advanced Electronic Design**

Max. Marks: 100

Duration: 3 Hours

Note: Certified IC data sheets of relevant ICs may be permitted inside the examination hall. However, application notes of ICs are NOT permitted.

PART A

Answer all questions, each carries 3 marks.

Marks

- | | | |
|---|--|-----|
| 1 | List the effects of Op-amp slew-rate in practical circuits. | (3) |
| 2 | Draw the high frequency equivalent circuit of an op-amp. | (3) |
| 3 | A randomly varying signal whose peak voltage was expected to be in the range -20 V to 35 V. Draw a peak detector circuit that gives the peak voltage value of the signal. What would be the nominal voltage ratings of the components used? Assume a suitable safety factor. | (3) |
| 4 | In a classical sample and hold circuit design explain the relevance of acquisition time. | (3) |
| 5 | How will the loading effect be affected if you replace a passive filter with an active filter in a measuring circuit? Give proper reasoning for your answer. | (3) |

- 6 How closely is the roll-off rate requirement associated with the order of an active filter? (3)
- 7 Mr X has designed a current measurement circuit based on hall effect sensor and the design had transient voltage suppressors for surge protection, active filters for noise separation and an isolation transformer for the purpose of isolating the measuring system from high power circuit. If given an opportunity, what corrections will you suggest without changing the sensor and why? (3)
- 8 List out the relevance of signal conditioning in a circuit that uses MPX2010 pressure sensor. (3)
- 9 List out any three characteristics of ADC in Atmega 32. (3)
- 10 What do you understand by the term conversion time in an ADC? (3)

PART B

Answer any two full questions, each question carries 14 marks.

- 11 a) Explain the relevance of unity gain bandwidth for an op-amp. (4)
- b) Derive the open loop voltage gain of an op-amp as a function of frequency. (10)

OR

- 12 a) An inverting amplifier with closed loop gain, $A_o = -2$ V/V is driven with a square wave of peak values $\pm V_m$ and frequency f . With $V_m = 2.5$ V. It is observed that the output turns from trapezoidal to triangular when f is raised to 250 kHz. With $f = 100$ kHz, it is found that slew-rate limiting ceases when V_m is lowered to 0.4 V. If the input is changed to a 3.5 V (rms) ac signal, what is the useful bandwidth of the circuit? (8)
- b) How does the frequency response of non-compensated Op-amps differ from compensated Op-amps? (6)
- 13 a) Describe the operation of a frequency-to-voltage converter with circuit diagrams and waveforms. (7)
- b) With a block-diagram, explain how a PLL can be used to implement a frequency multiplier. Use a multiplication factor of 2 for the illustration. (7)
- OR
- 14 (a) For a particular application we need to generate multiple copies of a reference current source. Describe an Op-amp circuit that generates mirror images of the current source which can serve the said purpose. (7)
- (b) It is required to design an amplifier for the current signal delivered by a photodetector. Use an Op-amp powered from ± 15 V power supply to deliver an output voltage in the range -5 V to +5 V for an input current in the range 0 to 1 A. (7)
- 15 (a) Design a unity gain second-order low-pass Butterworth filter with a -3 dB frequency of 10 kHz. If input, $V_i(t) = 10 \cos(4\pi \cdot 10^4 t - 90^\circ)$ V, find output $V_o(t)$. (8)

- (b) Derive an expression to find the cutoff frequency of a second order low pass Sallen-Key filter. (6)

OR

- 16 a) Explain the relevance of corner frequencies in filter characteristics. (5)
- b) Design a second order Sallen-Key high pass filter with a cutoff frequency of 10 kHz and Q of 1. Assume both resistors to be of equal value and both capacitors to be equal. (9)
- 17 a) Explain a temperature sensor circuit using the sensor AD590. (6)
- b) Design a differential pressure measuring circuit using MPX2010 pressure sensor with switching output. The output should switch at 5 kPa pressure difference. Assume zero offset of the sensor. Assume operating voltage of 10 V, temperature of measurement as 25°C and $P_1 > P_2$. *Hint: use a comparator at the output.* (8)

OR

- 18 a) To calibrate ADXL202E, the accelerometer's measurement axis is pointed directly at the earth. The 1g reading is saved and the sensor is turned 180° to measure -1g. Let A = accelerometer output with axis oriented to +1g = 55% duty cycle and B = accelerometer output with axis oriented to -1g = 32% duty cycle. What is the sensitivity of the accelerometer? (8)
- b) When two or more sensors are mounted close to each other, acoustic interference is possible. Describe the ways in which multiple ultrasonic sensors 873P can be connected. Give the connections for both the analog current and the analog voltage outputs. Assume that the sensors (6)

are connected away from an amplifier.

19 a) Differentiate between serial and parallel ADC. (7)

b) What is the relevance of a stable regulated supply voltage in an ADC. (7)

List the sampling requirements for successful reproduction in an ADC.

OR

20 It is required to interface the temperature sensor LM35 with Atmega32 (14)

for measuring the temperature of an element that varies in the range 0° C to 120° C. Draw the interfacing diagram with proper labelling of the Atmega 32 ports. Write an appropriately commented code for the same.

Syllabus

Module 1: Op-amp Frequency response-compensating networks, frequency response of internally compensated Op-Amps, frequency response of non compensated Op-Amps, High-frequency Op-amp equivalent circuit, open loop voltage gain as a function of frequency, closed loop frequency response, circuit stability, slew rate, slew rate equation, effect of slew rate.

Module 2: Advanced Op-amp applications- Precision rectifier, peak detector and log-converter, antilog amplifier, current mirror, voltage-to-current converters, current-to-voltage converters, voltage-to-frequency and frequency-to-voltage converters, Sample and hold circuit- Basic Circuits, practical sample and hold circuits, performance characteristics. Phase Locked Loop (PLL)- Operating principles, block diagrams, monolithic PLL, IC 565 - PLL applications.

Module 3: Filters- Introduction to basic theory of filters: Filter responses - Active vs passive filters, Low pass, Band-pass, high-pass, band-stop filters and their characteristics - first order vs higher order filters - Realisation of Active filters - Transfer function synthesis, Sallen Key based (VCVS) filters - First order low pass butterworth filter design and frequency scaling, second order low pass butterworth filter design.

Module 4: IC Sensors- IC sensors for different energy forms, thermal energy sensors, mechanical energy sensors, radiant energy sensors, magnetic energy sensors, chemical energy sensors. MEMS-typical IC sensors, temperature energy sensors- LM35 and AD590, pressure

sensors-MPX2010, accelerometer-ADXL202E, ultrasonic sensor-873P, infrared thermometer modules-MLX90601 family, Hall effect direction detection sensor-A3422xka

Module 5: ADC, DAC and sensor interfacing to a typical Microcontroller-Review of ADC and ADC characteristics-resolution, conversion time, parallel versus serial ADC with ADC0848 and MAX1112 examples, sampling requirements, ADC programming / interfacing in Atmega 32, interfacing temperature sensor LM35 with Atmega32, DAC 0808 interfacing with Atmega 32

Text Books

1. L. K. Maheswari, M.M.S Anand, "Analog Electronics", Prentice Hall India Learning Private Limited, 2005.
2. Muhammad Ali Mazidi, Sarmad Naimi, Sepehr Naimi, "The AVR Microcontroller and Embedded Systems: Using Assembly and C", Pearson Education India, 1st Edition, 2013

References

1. Ramakant A Gayakwad, "Op-amps and Linear Integrated Circuits", Pearson Education; Fourth edition, 2015
2. D Roy Choudhury, "Linear Integrated Circuits", New Age International Publishers; Fifth edition, 2018
3. Sergio Franco, "Design with operational amplifier and analog circuits" Third Edition, Mc Graw Hill, 2001
4. Elliot Williams, "Make: AVR Programming-Learning to write software for hardware", First edition, Shroff/Maker Media, 2014.
5. Data sheets and application notes of relevant ICs mentioned in the syllabus

Estd.



2014

Course Contents and Lecture Schedule

No	Topic	No. of Lectures
1	Module 1: Op-amp frequency response (8 hrs)	
1.1	Compensating networks, frequency response of internally compensated Op-Amps, frequency response of non compensated Op-Amps,	3 hrs
1.2	High-frequency Op-amp equivalent circuit,	1 hr
1.3	Open loop voltage gain as a function of frequency, closed loop frequency response, circuit stability,	2 hrs
1.4	Slew rate, slew rate equation, effect of slew rate	2 hrs
2	Module 2: Advanced Op-amp applications (8 hrs)	
2.1	Precision rectifier, peak detector and log-converter , antilog amplifier, current mirror, voltage-to-current converters, current-to-voltage converters, voltage-to-frequency and frequency-to-voltage converters,	4 hrs
2.2	Sample and hold circuit- Basic Circuits, practical sample and hold circuits, performance characteristics.	2 hrs
2.3	Phase Locked Loop (PLL)- Operating principles, block diagrams, monolithic PLL, IC 565 PLL applications.	2 hrs
3	Module 3: Filters (6 hrs)	
3.1	Introduction to basic theory of filters: Filter responses - Active vs passive filters, Low pass, Band-pass, high-pass, band-stop filters and their characteristics - first order vs higher order filters	2 hr
3.2	Realisation of Active filters - Transfer function synthesis, Sallen	2 hr

	Key based (VCVS) filters	
3.3	First order low pass butterworth filter design and frequency scaling, second order low pass butterworth filter design.	2 hrs
4	Module 4: IC Sensors (7 hrs)	
4.1	IC sensors for different energy forms, thermal energy sensors, mechanical energy sensors, radiant energy sensors, magnetic energy sensors, chemical energy sensors.	2 hrs
4.2	MEMS-typical IC sensors, temperature energy sensors- LM35 and AD590, pressure sensors-MPX2010, accelerometer-ADXL202E, ultrasonic sensor-873P, infrared thermometer modules-MLX90601 family, Hall effect direction detection sensor-A3422xka	5 hrs
5	Module 5: ADC, DAC and sensor interfacing to a typical Microcontroller (7 hrs)	
5.1	Review of ADC and ADC characteristics-resolution, conversion time, parallel versus serial ADC with ADC0848 and MAX1112 examples, Sampling requirements	4 hrs
5.2	ADC programming / interfacing in Atmega 32, interfacing temperature sensor LM35 with Atmega32, DAC 0808 interfacing with Atmega 32	3 hrs

Assessment Pattern

Bloom's Category	Continuous Assessment Tests		End Semester Examination
	1	2	
Remember (K1)	20	20	40
Understand (K2)	20	20	40
Apply (K3)	10	10	20
Analyse (K4)	-	-	-
Evaluate (K5)	-	-	-
Create (K6)	-	-	-

Mark distribution

Total Marks	CIE	ESE	ESE Duration
150	50	100	3 hours

Continuous Internal Evaluation Pattern:

Attendance	: 10 marks
Continuous Assessment Test (2 numbers)	: 25 marks
Assignment/Quiz/Course project	: 15 marks

End Semester Examination Pattern : There will be two parts; Part A and Part B. Part A contain 10 questions with 2 questions from each module, having 3 marks for each question. Students should answer all questions. Part B contains 2 questions from each module of which student should answer any one. Each question can have a maximum 2 sub-divisions and carry 14 marks.

Course Level Assessment Questions

Give questions indicating bloom's taxonomy level under each CO

Course Outcome 1 (CO1):

1. Which are the resistive forces that retard the motion of a four wheel vehicle?(PO1,K1)
2. Explain briefly the performance parameters of the vehicle.(PO1, PO2,K1)
3. What are the social and environmental importance of EV.(PO7, K1)

Course Outcome 2 (CO2):

1. Architecture and power flow control of hybrid electric vehicle.(PO2, K2)
2. Subsystems of an electric vehicle.(PO1, K1)

3. What is regenerative braking?(PO1, K1)

Course Outcome 3 (CO3):

1. Electric components of an electric vehicle. (PO1, K1)
2. Control of orthogonal flux and torque in a separately excited DC motor(PO2, K2)
3. FOC control concept in PMSM motors.(PO1, PO2,K2)

Course Outcome 4 (CO4):

1. Battery management supporting system for hybrid vehicle.(PO1, K2)
2. Numerical problems in sizing and selection of batteries (PO3, K3)
3. Pin diagrams and differences of various connectors used for EV charging.(PO2,K2)

Course Outcome 5 (CO5):

1. Torque - speed envelope curves of drive train motors (PO2,K1)
2. Numerical Problems in sizing of drive systems (PO3,K3)
3. Different communication protocols used in EV (PO1, K2)

Model Question Paper**QP CODE:****Pages:****Reg No.:** _____**Name:** _____

**APJ ABDUL KALAM TECHNOLOGICAL UNIVERSITY EIGHT SEMESTER
B.TECH DEGREE EXAMINATION,**

MONTH & YEAR

Course Code: EET 418

Course Name: ELECTRIC AND HYBRID VEHICLES

Max. Marks: 100**Duration: 3 hours**

PART A

Answer all questions; each question carries 3 marks.

1. Explain rolling resistance and aerodynamic drag in vehicles. (3)
2. Write short notes on gradeability of the automobile system (3)
3. With the help of a block diagram, explain the major components of an electric vehicle. (3)
4. What is axial balancing? (3)
5. What are the electric components used in the propulsion unit of EV/HEV? (3)

6. List the advantages of PMSM motors over DC and induction motors. (3)
7. Explain the terms specific energy and energy density as applied to batteries. (3)
8. Explain the V2G concept. (3)
9. What is meant by Constant Power Speed Ratio as applied to an electric motor? (3)
10. What is the significance of a communication network in electric/hybrid vehicles? (3)

PART B

Answer any one complete question from each section; each question carries 14 marks

- 11 (a) Draw and explain ideal traction power plant characteristics of various power plants and various power source characteristics used in electric and hybrid electric vehicles. (8)
 - (b) Why is a gear system needed for an ICE? Explain with relevant characteristic curves. (6)
- OR
- 12 (a) Explain the levels of automation and its significance in autonomous vehicles (5 marks)
 - (b) What are the resistive forces acting on the vehicle movement? Obtain the dynamic equation of the vehicle movement.
- 13 (a) Draw and explain different classification of electric vehicles based on power source configurations. (7)
 - (b) Explain the different power flow control modes of a typical parallel hybrid system with the help of block diagrams. (7)
- OR
- 14 (a) Explain in detail the EV drivetrain alternatives based on drivetrain configurations (6)
 - (b) Explain the different power flow control modes of a typical ICE dominated series-parallel hybrid system with the help of block diagrams (8)
- 15 (a) Explain the Permanent Magnet Synchronous Motor control for application in EV. (10)
 - (b) Describe the advantages of independent control of flux and torque in SEDC Motor (4)

OR

- 16 (a) Discuss in detail the various electrical components used in HEV. (10)
 (b) List the advantages of FOC control. (4)
- 17 (a) What is meant by the C rating of a battery? Explain with an example. (4)
 (b) Explain the operation, advantages and disadvantages of Fuel cells used in EV. (10)

OR

- 18 (a) Explain briefly the different charging systems used for charging of EV. (8)
 (b) With pin diagrams, describe the CCS Type 2 connectors used for EV charging. (6)
- 19 (a) A hybrid electric vehicle has two sources- an ICE with output power of 80kW and battery storage. The battery storage is a 150 Ah, C10 battery at 120V. (i). Calculate the battery energy capacity (ii). Without de-rating the Ahr capacity, what is the maximum power that can be supported by the battery? (iii). What is the electrical motor power output if the total efficiency of power converter and motor combination is 98%? (iv). What is the maximum power that can be transmitted to the wheels if the transmission efficiency is 95%? (8)
 (b) Explain briefly the factors to be considered while sizing the electric motor for EV. (6)

OR

- 20 (a) What does CP and PP pins denote in connectors and explain its functions (5)
 (b) Draw and explain the FLEXRAY communication systems used in EV. (9)

Syllabus

Module 1 - 8 hrs

Introduction to Hybrid Electric Vehicles: History of hybrid and electric vehicles, social and environmental importance of hybrid and electric vehicles, impact of modern drive-trains on energy supplies. (2 hrs)

Conventional Vehicles: Basics of vehicle performance, vehicle power source characterization, transmission characteristics, mathematical models to describe vehicle performance. (5 hrs)

Autonomous Vehicles: Levels of automation, significance & effects of automation in vehicles (1 hr)

Module 2 - 7 hrs

Hybrid Electric Drive-trains: Basic concept of hybrid traction, introduction to various hybrid drive-train topologies, power flow control in hybrid drive-train topologies, fuel efficiency analysis. (4 hrs)

Electric Drive-trains: Basic concept of electric traction, introduction to various electric drive-train topologies, power flow control in electric drive-train topologies, fuel efficiency analysis.(3 hrs)

Module 3 - 7 hrs

Electric Propulsion unit: Introduction to electric components used in hybrid and electric vehicles (2 hrs)

DC Drives: Review of Separately excited DC Motor control – Speed and torque equations - Independent control of orthogonal flux and torque - Closed loop control of speed and torque (block diagram only) (2 hrs)

PMSM Drives: PMSM motor basics – Independent control of orthogonal flux and torque (concept only)- Field Oriented Control (FOC) – Sensored and sensorless control (block diagram only) (3 hrs)

Module 4 - 7 hrs

Energy Storage: Introduction to energy storage requirements in Hybrid and Electric Vehicles- Battery based energy storage systems,Battery Management System, Types of battery- Fuel Cell based energy storage systems- Supercapacitors-Hybridization of different energy storage devices (3 hrs)

Overview of Electric Vehicle Battery Chargers - On-board chargers, Electric Vehicle Supply Equipment (EVSE) - Grid to EVSE to On-board chargers to battery pack power flow block schematic diagrams – Types of charging stations - AC Level 1 & 2, DC - Level 3 – V2G concept-Types of Connectors - CHAdeMO, CCS Type1 and 2, GB/T - PIN diagrams and differences (4hrs)

Module 5 - 5 hrs

Sizing the drive system: Matching the electric machine and the internal combustion engine (ICE), Sizing the propulsion motor, sizing the power electronics (3 hrs)

Vehicle Communication protocols : Need & requirements - Functions of Control Pilot (CP) and Proximity Pilot (PP) pins, Communication Protocols - CAN, LIN, FLEXRAY (Basics only)- Power line communication (PLC) in EV (2 hrs)

Text Books

1. Iqbal Hussein, Electric and Hybrid Vehicles: Design Fundamentals, CRC Press, 2003

References:

1. James Larminie, John Lowry, Electric Vehicle Technology Explained, Wiley, 2003.
2. Mehrdad Ehsani, YimiGao, Sebastian E. Gay, Ali Emadi, Modern Electric, Hybrid Electric and Fuel Cell Vehicles: Fundamentals, Theory and Design, CRC Press, 2004.
3. Chris Mi, M A Masrur, D W Gao, “ Hybrid Electric Vehicles – Principles and applications with practical perspectives,” Wiley, 2011
4. Anderson JM, Nidhi K, Stanley KD, Sorensen P, Samaras C, Oluwatola OA, Autonomous vehicle technology: A guide for policymakers, Rand Corporation, 2014

Online Resources:

1. NPTEL courses/Materials (IITG, IITM, IITD) – Electric and Hybrid vehicles
<https://nptel.ac.in/courses/108/103/108103009/> (IIT Guwahati)
<https://nptel.ac.in/courses/108/102/108102121/> (IIT Delhi)
<https://nptel.ac.in/courses/108/106/108106170/> (IIT Madras)
2. FOC Control - video lecture by Texas Instruments
<https://training.ti.com/kr/field-oriented-control-permanent-magnet-motors>
3. Sensored and sensorless FOC control of PMSM motors – Application notes (TI, MATLAB)
https://www.ti.com/lit/an/sprabz0/sprabz0.pdf?ts=1620018267996&ref_url=https%253A%252F%252Fwww.google.com%252F
<https://in.mathworks.com/help/phymod/sps/ref/pmsmfieldorientedcontrol.html>
4. Electric Vehicle Conductive AC Charging System
<https://dhi.nic.in/writereaddata/UploadFile/REPORT%20OF%20COMMITTEE636469551875975520.pdf>
[Electric Vehicle Conductive AC Charging System](#)

Course Contents and Lecture Schedule:

No.	Topic	No. of Lectures
1	Introduction to hybrid/electric, conventional & autonomous vehicles (8 hours)	
1.1	Introduction to Hybrid Electric Vehicles: History of hybrid and electric vehicles, social and environmental importance of hybrid and electric vehicles	1
1.2	Impact of modern drive-trains on energy supplies	1
1.3	Conventional Vehicles: Basics of vehicle performance	1
1.4	Vehicle power source characterization, transmission characteristics	2
1.6	Mathematical models to describe vehicle performance	2

1.7	Autonomous Vehicles: Levels of automation, significance & effects of automation in vehicles	1
2	Hybrid & Electric drive-trains (7 hours)	
2.1	Hybrid Electric Drive-trains: Basic concept of hybrid traction	1
2.2	Introduction to various hybrid drive-train topologies	1
2.3	Power flow control in hybrid drive-train topologies, fuel efficiency analysis.	2
2.4	Electric Drive-trains: Basic concept of electric traction, introduction to various electric drive-train topologies	1
2.5	Power flow control in electric drive-train topologies, hub motors, fuel efficiency analysis.	2
3	Electric Propulsion System (7 Hours)	
3.1	Electric Propulsion unit: Introduction to electric components used in hybrid and electric vehicles	2
3.2	DC Drives: Review of Separately excited DC Motor control – Speed and torque equations - Independent control of orthogonal flux and torque – Closed loop control of speed and torque (block diagram only)	2
3.3	PMSM Drives: PMSM motor basics – Independent control of orthogonal flux and torque (concept only)	2
3.4	Field Oriented Control (FOC) of Permanent Magnet Synchronous Motor – Sensored and sensorless control (block diagram only)	1
4	Energy Storage (7 Hours)	
4.1	Energy Storage: Introduction to energy storage requirements in Hybrid and Electric Vehicles- Battery based energy storage systems, Battery Management System	1
4.2	Types of battery-Lithium ion, Lead acid	1
4.3	Fuel Cell based energy storage systems- Supercapacitors-Hybridization of different energy storage devices	1
4.4	Overview of Electric Vehicle Battery Chargers – On-board chargers, Electric Vehicle Supply Equipment (EVSE) - Grid to EVSE to On-board chargers to battery pack power flow block schematic diagrams	2
4.5	Types of charging stations - AC Level 1 & 2, DC - Level 3	1
4.6	V2G concept-Types of Connectors - CHAdeMO, CCS Typ1 and 2, GB/T - PIN diagrams and differences	1

5	Sizing the drive system (5 Hours)	
5.1	Sizing the drive system :Matching the electric machine and the internal combustion engine (ICE)	1
5.2	Sizing the propulsion motor	1
5.3	Sizing the power electronics	1
5.4	Vehicle Communication protocols : Need and requirements - Functions of Control Pilot (CP) and Proximity Pilot (PP) pins	1
5.5	Communication Protocols - CAN, LIN, FLEXRAY(Basics only) –Power Line Communication (PLC) in EV	1

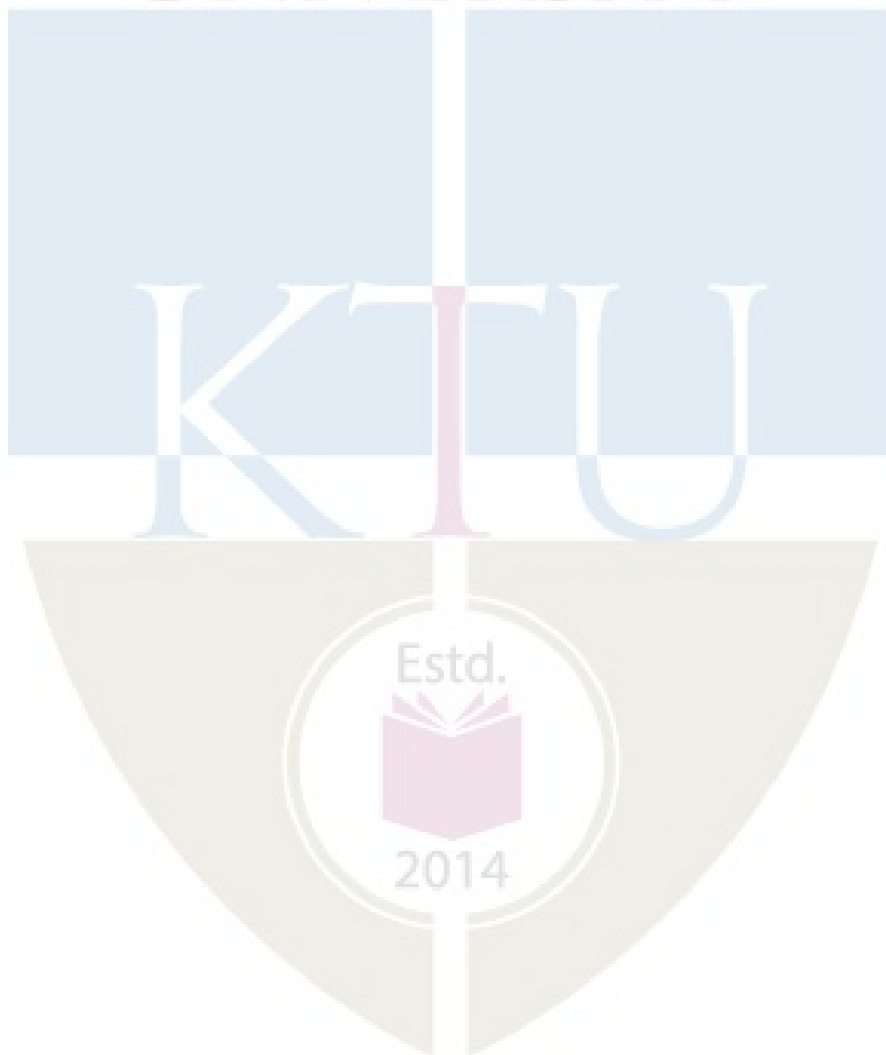

CODE	COURSE NAME	CATEGORY	L	T	P	CREDIT
EET428	INTERNET OF THINGS	PEC	2	1	0	3

Preamble: This elective course is designed for state-of-the-art features to students and enable them to work in the industry where IoT is applied to a great extent. Students will also be introduced to the programming of embedded devices used in different levels of IoT application. Moreover, they will get exposed to sensor interfacing and uploading data to cloud services provided by different firms.

Prerequisite: Experience in high level language programming and system design concepts with microcontrollers are required.

Course Outcomes: After the completion of the course the student will be able to

CO 1	Explain the role of computer networks in IoT. (K1)
CO 2	Select the appropriate communication standard for their IoT application. (K2)
CO 3	Use the appropriate sensors and embedded devices to get the data from the “things” and upload to cloud (K2)
CO 4	Develop programs for IoT devices using micropython language. (K3)
CO 5	Utilize the learned information to find an IoT based solution for the problem at hand. (K3)

Mapping of course outcomes with program outcomes

	PO 1	PO 2	PO 3	PO 4	PO 5	PO 6	PO 7	PO 8	PO 9	PO 10	PO 11	PO 12
CO 1	2											
CO 2	2											
CO 3	2	2			2							
CO 4	2	3	3	1	2				1			1
CO 5	2	3	3	1	2	2	1		1			1
CO 6												

Assessment Pattern

Bloom's Category	Continuous Assessment Tests		End Semester Examination
	1	2	
Remember	10	10	20
Understand	25	25	50
Apply	15	15	30
Analyse			
Evaluate			
Create			

Mark distribution

Total Marks	CIE	ESE	ESE Duration
150	50	100	3 hours

Continuous Internal Evaluation Pattern:

Attendance	: 10 marks
Continuous Assessment Test (2 numbers)	: 25 marks
Assignment/Quiz/Course project	: 15 marks

End Semester Examination Pattern: There will be two parts; Part A and Part B. Part A contain 10 questions with 2 questions from each module, having 3 marks for each question. Students should answer all questions. Part B contains 2 questions from each module of which student should answer any one. Each question can have maximum 2 sub-divisions and carry 14 marks.

Course Level Assessment Questions**Course Outcome 1 (CO1):**

1. Draw and explain the functional block diagram of IoT system.
2. Define the terms a) IP address b) Access point c) Station d) Router e) gateway
3. Explain the enabling technologies of IoT

Course Outcome 2 (CO2)

1. Explain the Wireless Sensor Network (WSN) technology.
2. How the data sensed from things uploaded to cloud?
3. Briefly explain the communication standards in use for connection to cloud service.

Course Outcome 3(CO3):

1. Explain the main features of Raspberry Pi 4 B computer
2. How ESP32 can be used as an embedded device in IoT applications?
3. Briefly explain the use ARM EMBED in IoT application.

Course Outcome 4 (CO4):

1. Prepare a micropython program to enable ESP32 module as an access point.
2. Prepare a micropython program to read analog data using raspberry pi and setup a server.
3. Explain the features of ARM EMBED IoT platform.

Course Outcome 5 (CO5):

1. Explain the application of IoT with suitable block diagram for smart metering of electricity
2. Detail the data sensing and prediction based on IoT applications in smart farming.
3. Detail the features of Industrial IoT with suitable block diagram.

Syllabus**EET 428: INTERNET OF THINGS****Module 1**

Introduction: Definition and Characteristics of IoT, Physical Design of IoT: Things in IoT, IoT Protocols, Logical Design of IoT: IoT Functional Blocks, IoT Communication Models, IoT Communication APIs, IoT Enabling Technologies. Design challenges – power consumption and security issues.

Computer networks: Internet-protocols and standards-OSI model- TCP/IP protocol suite. IP addressing – IPv4 and IPv6, Physical layer components- Switch, Router, Access point, station, Server, Client, Port, Gateway. Sizing of network- LAN, MAN, WAN . **(8 hrs)**

Module 2

IoT and M2M Communications: Introduction, M2M, M2M applications, Differences between M2M and IoT, M2M standards- Bluetooth-LE, Zigbee, NFC, Wifi and LoRaWAN. Data logging and cloud services- CoAP, MQTT and JSON. Big data analytics (concepts only)**(6 hrs)**

Module 3

Sensor technologies for IoT- Wireless sensor network. Voltage, Current, Speed, Temperature and humidity sensors and data acquisition using embedded devices- block diagram. Data logging to cloud services- protocols and programming. **(6 hrs.)**

Module 4

Embedded devices for IoT. Introduction to Python programming and embedded programming using micropython. Sensor interfacing and data acquisition using target boards like Raspberry Pi 4B, ARM EMBED, ESP32, Arduino boards. Programming examples for

data logging to cloud using micropython. (Assignments on hardware implementation using these or similar boards may be given.) **(8hrs.)**

Module 5

IoT applications: Energy management and smart grid applications. IoT based home automation, Smart metering for electricity consumers. IoT based weather stations, Agriculture- smart farming, Automobile IoT- Electric vehicles-platform and software, Industrial IoT. **(6 hrs.)**

Text Books

1. Simone Cirani, "Internet of things: Architecture, protocols and standards", Wiley, 2019
2. Charles Bell, "MicroPython for the Internet of Things: A Beginner's Guide to Programming with Python on Microcontrollers", Apress, 2017
3. B.K Thripathy, J Anuradha, "Internet of things (IoT) _ technologies, applications, challenges and solutions ", CRC press, 2018
4. Raj Kamal, "Internet of Things: Architecture and Design Principles", McGraw Hill (India) Private Limited.

Reference Books

1. Qusay F. Hassan, "Internet of Things A to Z,: Technologies and applications", IEEE press,2018
2. Gary Smart, "Practical Python Programming for IoT : Build advanced IoT projects using Raspberry Pi 4, MQTT, RESTful APIs, WebSockets, and Python 3, Packt Publishing Ltd, 2020.
3. Gaston C. Hillar , "MQTT Essentials - A Lightweight IoT Protocol" , Packt Publishing Ltd, 2017.
4. Alasdair Gilchrist , "Industry 4.0 The Industrial Internet of Things". Apress, 2016.

Course Contents and Lecture Schedule

No	Topic	No. of Lectures
1	Module I	
1.1	Introduction to IoT, functional block	2
1.2	IoT communication models, Design challenges	2
1.3	Computer networks related topics	4
2	Module II	
2.1	Introduction to M2M communications, standards	2
2.2	Data logging and cloud services, MQTT,json	3
2.3	Big data analytics (concepts only)	1
3	Module III	

3.1	Sensors and sensor networks	1
3.2	Voltage ,current, temperature sensors and their interfaces	2
3.3	Data logging to cloud services and protocols	3
4	Module IV	
4.1	Introduction to embedded devices like Raspberry Pi, ESP32 etc	2
4.2	Introduction to micropython programming	3
4.3	Micropython programming for data logging to cloud	3
5	Module V	
5.1	IoT applications in smart grids	3
5.2	IoT application to other applications	1
5.3	IoT applications in electric vehicles and IIoT	2

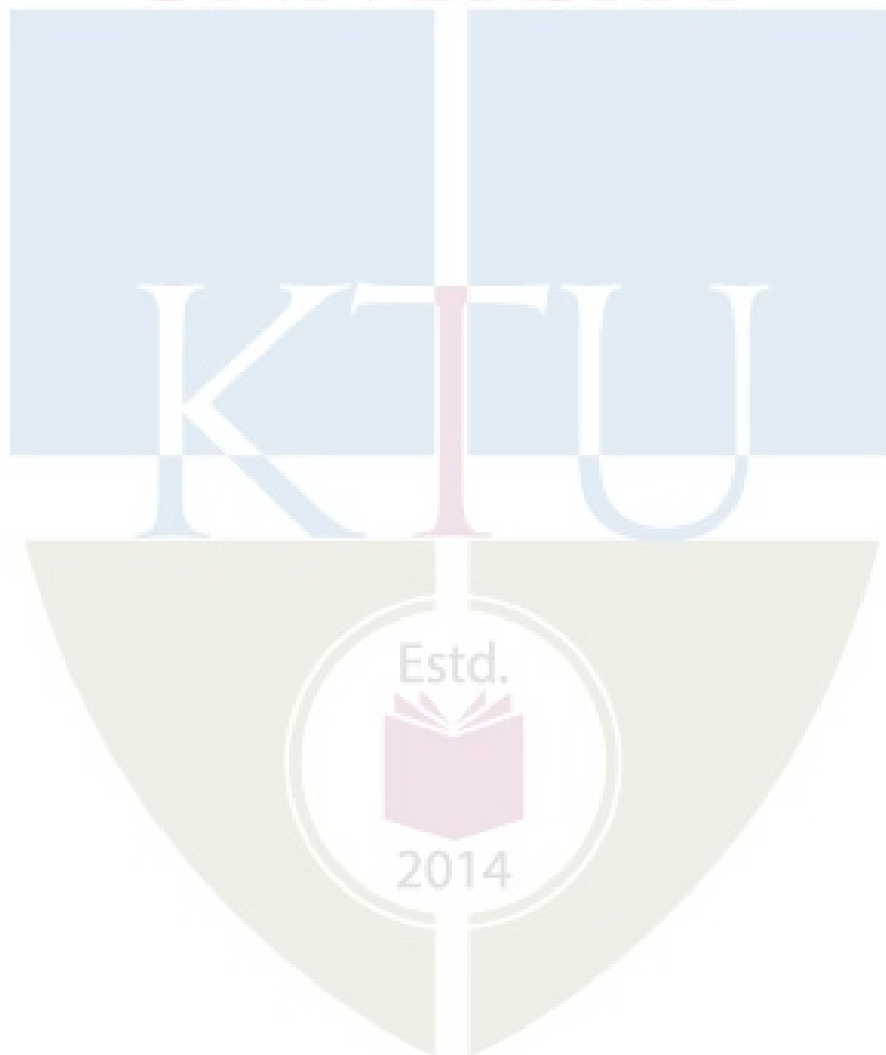

CODE	COURSE NAME	CATEGORY	L	T	P	CREDIT
EET438	ENERGY STORAGE SYSTEMS	PEC	2	1	0	3

Preamble: This course aims to introduce the importance and application of energy storage systems and to familiarize with different energy storage technologies.

Prerequisite: Nil

Course Outcomes: After the completion of the course the student will be able to

CO 1	Identify the role of energy storage in power systems
CO 2	Classify thermal, kinetic and potential storage technologies and their applications
CO 3	Compare Electrochemical, Electrostatic and Electromagnetic storage technologies
CO 4	Illustrate energy storage technology in renewable energy integration
CO 5	Summarise energy storage technology applications for smart grids)

Mapping of course outcomes with program outcomes

	PO 1	PO 2	PO 3	PO 4	PO 5	PO 6	PO 7	PO 8	PO 9	PO 10	PO 11	PO 12
CO 1	3	2										
CO 2	3											
CO 3	3	2	1				1					
CO 4	3	2	1			1	1					1
CO 5	3	1	1			1	1					1

Assessment Pattern

Bloom's Category	Continuous Assessment Tests		End Semester Examination
	1	2	
Remember (K1)	15	15	30
Understand (K2)	20	20	40
Apply (K3)	15	15	30
Analyse (K4)			
Evaluate (K5)			
Create (K6)			

Mark distribution

Total Marks	CIE	ESE	ESE Duration
150	50	100	3 hours

Continuous Internal Evaluation Pattern:

Attendance	: 10 marks
Continuous Assessment Test (2 numbers)	: 25 marks
Assignment/Quiz/Course project	: 15 marks

End Semester Examination Pattern: There will be two parts; Part A and Part B. Part A contain 10 questions with 2 questions from each module, having 3 marks for each question. Students should answer all questions. Part B contains 2 questions from each module of which student should answer any one. Each question can have maximum 2 sub-divisions and carry 14 marks.

Course Level Assessment Questions**Course Outcome 1 (CO1)**

1. What are the different parts of a complete energy storage unit? (K1, PO1)
2. Explain the Dynamic Duty of storage plant. (K2, PO1,PO2)
3. What are the different types of central store? (K2, PO1)

Course Outcome 2 (CO2)

1. List the applications of thermal energy storage systems. (K1, PO1)
2. Explain hydrogen-based power utility concept.(K2,PO1)
3. What are the different storage containments of hydrogen? (K1, PO1)

Course Outcome 3(CO3)

1. Explain the working of fuel cell along with schematic diagram. (K2, PO1,PO2,PO7)
2. Write short notes on supercapacitors. (K2, PO1)
3. Explain the arrangement of a control and protection system for Super Conducting Magnetic Energy Storage.(K2 , PO1,PO3)

Course Outcome 4 (CO4)

1. Explain small-scale hydroelectric energy. (K2,PO1,PO3,PO6,PO7,PO12)
2. Write short notes on wave energy and its storage system. (K2, PO1, PO7,PO12)
3. What are the different types of renewable power sources? (K1, PO1, PO7,PO12)

Course Outcome 5 (CO5)

1. Explain distributed energy storage system. (K2, PO1, PO3, PO6, PO7, PO12)
2. What are the characteristics of smart grid system? (K1, PO1, PO6, PO7, PO12)
3. What is demand response? (K1, PO1, PO2)

Model Question Paper

QP CODE: _____

Pages: _____

Reg No.: _____

Name: _____

APJ ABDUL KALAM TECHNOLOGICAL UNIVERSITY EIGHTH SEMESTER**B.TECH DEGREE EXAMINATION,****MONTH & YEAR****Course Code: EET438****Course Name: ENERGY STORAGE SYSTEMS**

Max. Marks: 100

Duration: 3 hours

PART A**Answer all questions; each question carries 3 marks.**

1. Discuss the power transformation of energy storage system. (3)
2. Explain the different components of energy storage system with schematic structure. (3)
3. Define Flow equation related to thermal energy storage system. (3)
4. Write the difference between hybrid and combined energy storage in power system. (3)
5. Explain the chemical reaction of lead acid batteries. (3)
6. Write down the basic principle of capacitor bank storage system. (3)
7. Classify hydro power plants based on their rated capacity. (3)
8. Briefly discuss small-scale hydroelectric energy system. (3)

9. What is distributed energy storage system? (3)
- 10 List the various layers of smart grid. (3)

PART B

Answer any one complete question from each section; each question carries 14 marks

- 11 (a) Explain static duty of energy storage plant. (8)
- (b) With neat diagram explain energy and power balance in a storage unit. (6)

OR

- 12 (a) Explain the econometric model of energy storage. Derive the expression for annual cost of the system. (10)
- (b) What are the key parameters considered for the comparison of energy storage in power system? (4)
- 13 (a) Discuss the working principle of compressed air energy storage system. (7)
- (b) Write short note on flywheel energy storage system. (7)

OR

- 14 (a) Write any three industrial methods to produce hydrogen. (9)
- (b) Explain 'power to gas' concept. (5)
- 15 (a) Explain the working of Li-ion batteries. (7)
- (b) Describe the typical voltage–discharge profile for a battery cell. (7)

OR

- 16 (a) Describe basic principle and working of superconducting magnetic energy storage system. (7)
- (b) With the help of a block diagram, explain the arrangement of control and (7)

protection system for superconducting magnetic energy storage system.

- 17 (a) What are the main features of renewable energy systems? (4)
- (b) Explain the role of storage systems in an integrated power system with grid-connected renewable power sources. (10)

OR

- 18 (a) Explain photovoltaics system. (4)
- (b) Discuss the role of storage in an isolated power system with renewable power sources. (10)

- 19 (a) Describe the distributed energy storage system. (6)
- (b) "HEV act as a distributed energy generator and storage", justify your answer. (8)

OR

- 20 (a) What is demand response? (5)
- (b) Draw and explain the battery SCADA system. (9)

Estd.



2014

Syllabus

Module 1

Introduction to energy storage in power systems (6)

Need and role of energy storage systems in power system, General considerations, Energy and power balance in a storage unit, Mathematical model of storage system: modelling of power transformation system (PTS)-Central store (CS) and charge-discharge control system (CDCS), Econometric model of storage system.

Module 2

Overview on Energy storage technologies (7)

Thermal energy: General considerations -Storage media- Containment- Thermal energy storage in a power plant, Potential energy: Pumped hydro-Compressed Air, Kinetic energy: Mechanical- Flywheel , Power to Gas : Hydrogen - Synthetic methane

Module 3

Overview on Energy storage technologies (8)

Electrochemical energy : Batteries- Battery parameters: C-rating -SoC- DoD- Specific Energy-Specific power (numerical examples), Fuel cells, Electrostatic energy (Super Capacitors), Electromagnetic energy (Super conducting Magnetic Energy Storage), Comparative analysis, Environmental impacts of different technologies.

Module 4

Energy storage and renewable power sources (6)

Types of renewable energy sources: Wave - Wind – Tidal – Hydroelectric - Solar thermal technologies and Photovoltaics, Storage role in isolated power systems with renewable power sources, Storage role in an integrated power system with grid-connected renewable power sources

Module 5

Energy storage Applications (7)

Smart grid, Smart microgrid, Smart house, Mobile storage system: Electric vehicles – Grid to Vehicle (G2V)-Vehicle to Grid (V2G), Management and control hierarchy of storage systems - Aggregating energy storage systems and distributed generation (Virtual Power Plant Energy Management with storage systems), Battery SCADA, Hybrid energy storage systems: configurations and applications.

Text Books

1. A.G.Ter-Gazarian, “Energy Storage for Power Systems”, Second Edition, The Institution of Engineering and Technology (IET) Publication, UK, (ISBN - 978-1-84919-219-4),2011.
2. Francisco Díaz-González, Andreas Sumper, Oriol Gomis-Bellmunt,” Energy Storage in Power Systems” Wiley Publication, ISBN: 978-1-118-97130-7, Mar 2016.

Reference Books

1. Electric Power Research Institute (USA), “Electricity Energy Storage Technology Options: A White Paper Primer on Applications, Costs, and Benefits” (1020676), December 2010.
2. Paul Denholm, Erik Ela, Brendan Kirby and Michael Milligan, “The Role of Energy Storage with Renewable Electricity Generation”, National Renewable Energy Laboratory (NREL) -a National Laboratory of the U.S. Department of Energy.
3. P. Nezamabadi and G. B. Gharehpetian, "Electrical energy management of virtual power plants in distribution networks with renewable energy resources and energy storage systems”, *IEEE Power Distribution Conference*, 2011.

Course Contents and Lecture Schedule

No	Topic	No. of Lectures
1	Introduction to energy storage for power systems: (6)	
1.1	General considerations- different parts of energy storage unit- static duty of storage plant- dynamic duty of storage plant	2
1.2	Energy and power balance in a storage unit- schematic structure of energy storage	1
1.3	Mathematical model of storage system	1
1.4	Econometric model of storage- capital cost of energy storage- annual cost of storage facility	2
2	Overview on Energy storage technologies: (7)	
2.1	Principle of thermal energy storage- sensible heat storage – latent heat storage- containment- thermal energy storage in power plant application	2
2.2	Principle and operation of pumped hydroelectric storage (PHS)- general considerations- schematic diagram	1
2.3	Principle and operation of Compressed Air Energy Storage (CAES)- general considerations- basic principle-industrial application	1
2.4	Principle and operation of Flywheel Energy storage System (FESS)-general considerations -applications	1
2.5	General considerations- synthetic storage media-Hydrogen production-Hydrogen based power utility concept- storage containment for hydrogen-Methods of extraction of methane-	2

	Block diagram Power to gas concept	
3	Overview on Energy storage technologies (8)	
3.1	Basic concepts of conventional batteries and flow batteries- Battery parameters- C-rating-SoC- DoD- Specific Energy-Specific power (numerical examples), Fuel cell- Schematic diagram of an electrochemical fuel cell	2
23.2	Super conducting Magnetic Energy Storage (SMES)- basic circuit- principle-advantages	2
3.3	The Supercapacitor Energy Storage System- topology-principle- advantages	2
3.4	Comparative study of different energy storage system based on specific energy, specific power, cycling capability and life in years	2
4	Energy storage and renewable power sources (6)	
4.1	Types of renewable power sources- brief description	2
4.2	Storage role in isolated power system with renewable power sources	1
4.3	Storage role in an integrated power system with grid-connected renewable power sources	1
4.4	Small scale hydroelectric energy	1
4.5	Solar thermal technologies and photovoltaics	1
5	Energy storage Applications (7)	
5.1	Smart grid-concepts- characteristics- Smart metering	2
5.2	Field of Electromobility- thyristor based battery charger and DC power supply	1
5.3	Vehicle to grid and grid to vehicle charging point topology	1
5.4	Distributed energy storage	1
5.5	Battery SCADA- overview	1
5.6	Hybrid energy storage systems: configurations and applications	1

Bloom's Category	Continuous Assessment Tests		End Semester Examination
	1	2	
Remember	10	10	10
Understand	20	20	20
Apply	20	20	70
Analyse			
Evaluate			
Create			

Mark distribution

Total Marks	CIE	ESE	ESE Duration
150	50	100	3 hours

Continuous Internal Evaluation Pattern:

- Attendance : 10 marks
- Continuous Assessment Test (2 numbers) : 25 marks
- Assignment/Quiz/Course project : 15 marks

End Semester Examination Pattern: There will be two parts; Part A and Part B. Part A contain 10 questions with 2 questions from each module, having 3 marks for each question. Students should answer all questions. Part B contains 2 questions from each module of which student should answer any one. Each question can have maximum 2 sub-divisions and carry 14 marks.

Course Level Assessment Questions**Course Outcome 1 (CO1):**

1. Define the various norms of a system.(K1,PO1)
2. Compute the various norms of a system.(K2,PO2)
3. Identify the properness, stabilizability and detectability of the given system.(K2,PO2)

Course Outcome 2 (CO2)

1. Define Robust Stability and Performance of a system. (K1,PO1)
2. Apply Robust Stability and Performance measures for a system.(K3,PO3)
3. Use additive and multiplicative uncertainty to model an uncertain system.(K3,PO2,PO3)

Course Outcome 3(CO3):

1. Explain the formulation of H_2 control. (K2,PO2)
2. Explain the formulation of H_∞ control. (K2,PO2)
3. Explain the formulation of controller using mu synthesis. (K2,PO2)

Course Outcome 4 (CO4):

1. Differentiate between variable structure control and SMC.(K2,PO2)
2. Explain the formulation of sliding mode control.(K2,PO3)
3. Explain the method of sliding surface design using pole placement method.(K3,PO3)

Course Outcome 5 (CO5):

1. Illustrate the block diagram of any one adaptive scheme.(K2,PO2)
2. Design a MRAC using MIT rule.(K3,PO3)
3. Distinguish adaptive versus conventional feedback system.(K2,PO2)

Model Question Paper**QP CODE:****PAGES:2****Reg.No:** _____**Name:** _____

APJ ABDUL KALAM TECHNOLOGICAL UNIVERSITY
EIGHTH SEMESTER B.TECH DEGREE EXAMINATION,
MONTH & YEAR

Course Code: EET 448**Course Name: ROBUST AND ADAPTIVE CONTROL****Max. Marks: 100****Duration:3 Hours****PART A (3 x 10 = 30 Marks)****Answer all Questions. Each question carries 3 marks**

1. Calculate the 2-norm and ∞ -norm of the given vector $x = [1 \ -2 \ -3 \ 4]^T$.
 $x = [1 \ -2 \ -3 \ 4]^T$
2. Define H_2 and H_∞ norm.
3. Define Small gain theorem.
4. Explain the importance of Sensitivity function in robust control.
5. Formulate the standard LQR problem.
6. Explain the lack of Robustness of LQG control.
7. Differentiate between variable structure control and SMC.
8. What is chattering phenomenon in Sliding mode control? How does it affect the system?
9. Justify the statement "Process variations affect the performance of a system" with example.
10. List three applications of Adaptive control.

PART B (14 x 5 = 70 Marks)

Answer any one full question from each module. Each question carries 14 marks

Module 1

11. a) What is observability and controllability grammian. (8)

b) What is meant by Singular values of a transfer function matrix? What is their significance. (6)

12. a). How is H_∞ norm computed for a SISO system? How is H_∞ norm computation done for a MIMO system? (8)

b) The system given by

$$\dot{x} = Ax + Bu, y = Cx, \text{ where } A = \begin{bmatrix} -1 & 0 & 0 \\ 0 & 3 & 0 \\ 0 & 0 & -2 \end{bmatrix}, B = \begin{bmatrix} 0 \\ 0 \\ 1 \end{bmatrix}, C = [1 \quad 1 \quad 0]$$

$$\dot{x} = Ax + Bu, y = Cx, \text{ where } A = \begin{bmatrix} -1 & 0 & 0 \\ 0 & 3 & 0 \\ 0 & 0 & -2 \end{bmatrix}, B = \begin{bmatrix} 0 \\ 0 \\ 1 \end{bmatrix}, C = [1 \quad 1 \quad 0]$$

Check the stabilizability and detectability of the system. (6)

Module 2

13.a) Explain the terms nominal stability, robust stability, nominal performance and robust performance. What are the conditions to be satisfied by a feedback control system for each of the above? (10)

b) Identify the type of uncertainty in the given figure below. Write the mathematical model of the same.

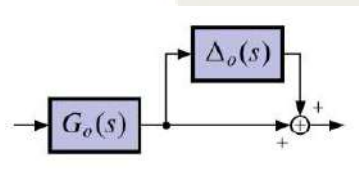

(4)

14. a) Explain the concept of loop shaping in achieving robustness. (7)

b) Derive the LFT of the given figure below.

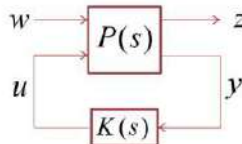

(7)

Module 3

15. a) Determine a LQR controller for the system defined by $\dot{x} = Ax + Bu$, where $A = \begin{bmatrix} 0 & 1 \\ 0 & -1 \end{bmatrix}$, $B = \begin{bmatrix} 0 \\ 1 \end{bmatrix}$ such that the performance index $J = \int_0^{\infty} (x^T x + u^2) dt$ is minimised. (8)
- b) Explain the formulation of LQG control. (6)
16. a) Explain the formulation of H_{∞} control. (6)
- b) What is a structured singular value. Mention the steps in designing a stabilizing controller by mu synthesis. (8)

Module 4

- 17.a) Write down the steps to be followed for designing a sliding mode controller. Also list the main features of sliding mode controllers. (4)
- b) Design a stabilising variable structure control for a double integrator system (10)
- 18.a) Write two different reaching laws associated with sliding mode control design. Show how they assist the design to satisfy the reachability condition. (8)
- b) In a sliding mode there exists a finite reaching time $t = t_f$ at which switching function $s(t)$ becomes 0. Derive an expression for t_f in terms of $s(0)$. (6)

Module 5

19. a) Explain the design of Self Tuning Regulator by pole placement design. (8)
- b) Explain the least square estimation for parameter estimation. (6)
20. a) Design a MRAC for a first order system using MIT rule. (8)
- b) Explain with illustration the basic blocks of a MRAS. (6)

Syllabus

Module 1: Introduction and mathematical preliminaries(8 hours)

Introduction to robust control

Vector space, linear subspaces, Norm and inner product of real vectors and matrix, Hilbert Spaces , H_2 and H_{∞} Spaces - Computing of H_2 and H_{∞} norms(transfer function and transfer matrices) , Computing of L_2 and L_{∞} Norms, singular value decomposition.

Proper systems, Controllability and Observability Grammians, Concept of Minimal Realisation, Stabilizability and Detectability, Packed form notation- various configurations.

Module 2: Feedback systems and Uncertainty modelling(9 hours)

Single degree and two degree of freedom Robust Control Systems - System Sensitivity, Relation between Sensitivity and disturbance inputs in a feedback system, Sensitivity and Complementary Sensitivity function. Sensitivity and Complementary Sensitivity peak selection- its relation to gain and phase margin - Weighted Sensitivity and weighted complementary sensitivity.

Well-Posedness of Feedback Loop, Internal Stability.

Model Uncertainty - Classification of uncertainties -parametric, structured and unstructured- m - δ configuration- linear fractional transformation-examples.

Nominal Performance, Nominal Stability, Robust Performance and Robust Stability-Small Gain Theorem, Concept of loop shaping.

Module 3: Robust controller design(7 hours)

Introduction to Regulator problem, Standard LQR and LQG problem, control-Lack of Robustness , Introduction to H_2 control, H_{∞} control, μ Synthesis.

Module 4:Design of Sliding mode controllers (7 hours)

Introduction to Variable Structure Systems (VSS) - examples , Introduction to sliding mode control- -sliding surface- examples of dynamical systems with sliding modes, reaching laws- reachability condition, Invariance conditions- chattering-equivalent control, Design of sliding mode controllers using pole placement, LQR method.

Module 5: Introduction to Adaptive Control(7 hours)

Adaptive Control, effects of process variation - Adaptive Schemes - Adaptive Control problem - Applications - RealTime Parameter Estimation: Introduction - Regression Models - Recursive Least Squares, Self Tuning Regulators introduction, pole placement design, Model Reference Adaptive systems (MRAS) - the need for MRAS , MIT rule, MRAS for first order system.

Text Books

1. Sigurd Skogestad and Ian Postewaite, “Muti-variable Feedback Design” (Second Edition), John Wiley, 2005.
2. Kemin Zhou and Doyle J.C, “Essentials of Robust Control”, Prentice-Hall, 1998.
3. C Edwards and Sarah Spurgeon, “ Sliding Mode Control: Theory And Applications”, Taylor and Francis,1998
4. K. J. Astrom and B. Wittenmark, “Adaptive Control”, 2nd Edition, Addison-Wesley, 1995

Reference Books

1. P C Chandrasekharan, “Robust Control of Linear Dynamical Systems”, Academic Press, 1996
2. Richard C. Dorf, Robert H. Bishop, “Modern Control Systems”, Pearson Education, 2008.
3. S. Sastry and M. Bodson, “Adaptive Control”, Prentice-Hall, 1989
3. John C. Doyle, Bruce A. Francis, Allen R. Tannenbaum, “Feedback Control Theory” , Macmillan Pub. Co, 1992

Course Contents and Lecture Schedule

No	Topic	No. of Lectures
1	Introduction and mathematical preliminaries(8 hours)	
1.1	Introduction to robust control, Vector space, linear subspaces, Norm and inner product of real vectors and matrix,	2
1.2	Hilbert Spaces, H_2 and H_{inf} Spaces - Computing of H_2 and H_{inf} norms(transfer function and transfer matrices) , Computing of L_2 and L_{inf} Norms, singular value decomposition.	3
1.3	Proper systems- various types, Review of Minimal Realisation, Stabilizability and Detectability, Packed form notation- various configuration,	3
2	Feedback systems and Uncertainty modelling(9 hours)	
2.1	Single degree and two degree of freedom Robust Control Systems - System Sensitivity, Relation between Sensitivity and disturbance	2

	inputs in a feedback system, Sensitivity and Complementary Sensitivity function.	
2.2	Sensitivity and Complementary Sensitivity peak selection- its relation to gain and phase margin - Weighted Sensitivity and weighted complementary sensitivity. Well-Posedness of Feedback Loop, Internal Stability.	2
2.3	Model Uncertainty - Classification of uncertainties -parametric, structured and unstructured-m-delta configuration- linear fractional transformation-examples.	3
2.4	Nominal Performance, Nominal Stability, Robust Performance and Robust Stability-Small Gain Theorem, Concept of loop shaping.	2
3	Robust controller design(7 hours)	
3.1	Introduction to Regulator problem, Standard LQR and LQG problem, control-Lack of Robustness ,	3
3.2	Introduction to H2 control, Hinf control, mu Synthesis.	4
4	Design of Sliding mode controllers (7 hours)	
4.1	Introduction to Variable Structure Systems (VSS)- examples , Introduction to sliding mode control- -sliding surface- examples of dynamical systems with sliding modes , reachability condition, Invariance conditions- chattering-equivalent control	5
4.2	Design of sliding mode controllers using pole placement, LQR method.	2
5	Introduction to Adaptive Control(7 hours)	
5.1	Adaptive Control, effects of process variation - Adaptive Schemes - Adaptive Control problem - Applications	1
5.2	RealTime Parameter Estimation: Introduction - Regression Models - Recursive Least Squares,	2

5.3	Self Tuning Regulators introduction, pole placement design,	2
5.4	Model Reference Adaptive systems (MRAS) - the need for MRAS , MIT rule, MRAS for first order system.	2

APJ ABDUL KALAM
TECHNOLOGICAL
UNIVERSITY

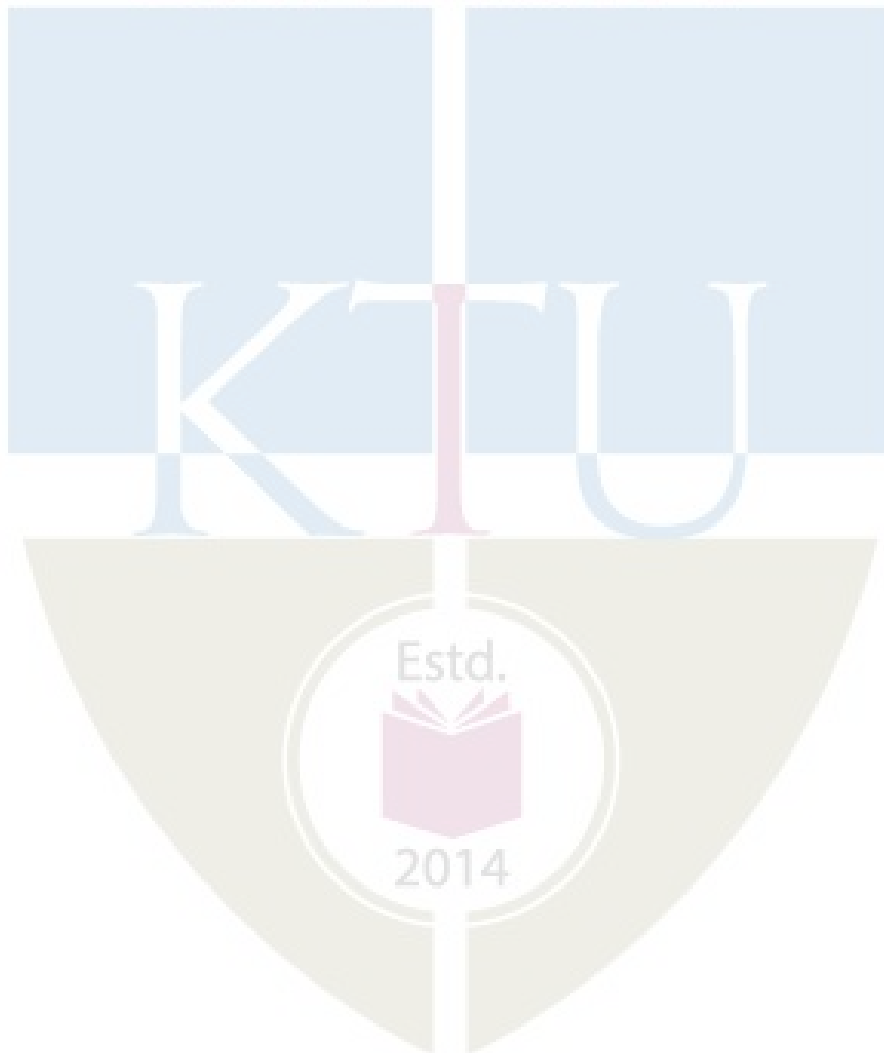

CODE	COURSE NAME	CATEGORY	L	T	P	CREDIT
EET458	SOLAR PV SYSTEMS	PEC	2	1	0	3

Preamble: This course introduces solar PV system and its grid integration aspects. It also give insight to basic knowhow for the implementation of Solar PV system utilizing modern simulation software.

Prerequisite : Nil

Course Outcomes : After the completion of the course the student will be able to:

CO 1	Explain the basics of solar energy conversion systems.(K1)
CO 2	Design a standalone PV system. (K3)
CO 3	Demonstrate the operation of a grid interactive PV system and its protection against islanding.(K2)
CO 4	Utilize life cycle cost analysis in the planning of Solar PV System (K3)

Mapping of course outcomes with program outcomes

	PO 1	PO 2	PO 3	PO 4	PO 5	PO 6	PO 7	PO 8	PO 9	PO 10	PO 11	PO 12
CO 1	3	1										1
CO 2	3	3	3									2
CO 3	3	3	2									2
CO 4	3	3	2	1	2						1	2

Assessment Pattern

Bloom's Category	Continuous Assessment Tests		End Semester Examination
	1	2	
Remember (K1)	10	10	20
Understand (K2)	25	25	50
Apply (K3)	15	15	30
Analyse (K4)	-	-	-
Evaluate (K5)	-	-	-
Create (K6)	-	-	-

End Semester Examination Pattern : There will be two parts; Part A and Part B. Part A contain 10 questions with 2 questions from each module, having 3 marks for each question. Students should answer all questions. Part B contains 2 questions from each module of which student should answer any one. Each question can have maximum 2 sub-divisions and carry 14 marks.

Course Level Assessment Questions**Course Outcome 1 (CO1):**

1. Explain what do you mean by solar constant (K1, PO1)
2. Discuss about the different instruments used for measuring solar radiation and sun shine (K2,PO2)

Course Outcome 2 (CO2):

1. Design a stand alone PV system. (K3, PO1, PO2, PO3)
3. Design an off grid PV system to backup 10kW system for 3 hours and draw the block level representation of the final system. (K3, PO1, PO2, PO3)

Course Outcome 3 (CO3):

1. Demonstrate the operation of a grid connected PV system. (K2, PO1, PO2,PO3).
2. Summarize the protection of PV system against islanding and reverse power flow. (K2, PO1, PO2,PO3).

Course Outcome 4 (CO4):

1. The life cycle cost of a system is Rs. 10000/- for a life period of 20 years. The rate of interest is 8% and the inflation rate is 5%. What is the annual life cycle cost for the system? (K3, PO1, PO2,PO3)
2. Design a grid connected PV system utilizing a suitable simulation software. (K3, PO1, PO2,PO3,PO4,PO5)

Model Question Paper**QP CODE:**

PAGES:2

Reg. No: _____

Name: _____

**APJ ABDUL KALAM TECHNOLOGICAL UNIVERSITY
EIGHTH SEMESTER B.TECH DEGREE
EXAMINATION, MONTH & YEAR**

Course Code: EET458

Course Name: SOLAR PV SYSTEMS

Max. Marks: 100

Duration: 3 Hours

PART A (3 x 10 = 30 Marks)

Answer all Questions. Each question carries 3 Marks

1. Explain briefly what do you mean by solar azimuth angle and zenith angle.
2. Differentiate between extraterrestrial and terrestrial solar radiation.

3. Write notes on the working of a solar cooker.
4. Discuss what do you mean by a solar green house.
5. Write notes on the different materials used for making solar cells.
6. Discuss the characteristics of a solar cell.
7. Give a description on of Power Quality related IEEE standards for distributed resource grid integration
8. Differentiate SoC and DoD of storage battery .
9. Write notes on the planned and unplanned islanding .
10. Explain life-cycle cost of renewable energy system.

PART B (14 x 5 = 70 Marks)

Answer any one full question from each module. Each question carries 14 Marks

Module 1

11. a. With the help of a neat diagram, explain the working of a pyrheliometer. (7)
 b. Explain how monthly average solar radiation on inclined surfaces can be calculated. (7)
12. a. State the reasons for variation in the amount of solar energy reaching earth surface. (4)
 b. With the help of a neat diagram, explain the working of a sunshine recorder. (6)
 c. Explain the difference in the working of pyrheliometer and pyranometer. (4)

Module 2

13. a. Explain the different types of solar collectors based on the way they collect solar radiation. (7)
 b. Explain in detail, the working of a solar air conditioning system (7)
14. a. With the help of a diagram, explain the function of different components of a flat plate solar collector. (7)
 b. Design a solar water heater for domestic application. (7)

Module 3

15. a. Write notes on the efficiency of a solar cell. (3)
 b. Discuss the effect of shadowing on the performance of solar cells. (3)
 c. Explain how maximum power point tracking can be done using buck-boost converter. (8)
16. a. Compare the performance of single junction and multijunction PV modules. (4)
 b. Write notes on packing factor of a PV module. (3)
 c. Explain the Perturb and Observe MPPT method. Compare with incremental conductance method. (7)

Module 4

- 17.
- Design an off grid PV system to backup 10kW system for 3 hours and draw the block level representation of the final system. (7)
 - Explain with a neat sketch, the working principle of a grid connected solar system. (7)
- 18.
- In a water pumping system, the water is being pumped from a sump to an overhead tank situated 25m above ground. The sump bottom is 2m below ground. The motor-pump system is located at ground level. The water is being pumped at the rate of 24.6 litres/sec. The pipe inner diameter is 10 cm. The pipe is placed completely vertical with no horizontal part. The friction factor is 0.037. The efficiencies of the pump, motor and dc-dc converter are 70%, 80% and 90% respectively. If the system is being powered by a PV source, what is the output power requirement for the PV panels? (7)
 - Explain the voltage and frequency matching method in grid connected PV system. (7)

Module 5

- 19.
- Detail the anti-islanding protection with suitable block diagram. (7)
 - The life cycle cost of a system is Rs. 10000/- for a life period of 20 years. The rate of interest is 8% and the inflation rate is 5%. What is the annual life cycle cost for the system? (7)
- 20.
- Draw and explain the line of protection equipment in PV array installation. (6)
 - Suppose the energy-efficiency retrofit of a large building reduces the annual electricity demand for heating and cooling from 2.3×10^6 kWh to 0.8×10^6 kWh and the peak demand for power from by 150 kW. Electricity costs Rs. 5/kWh and demand charges are Rs. 500/kW per month, both of which are projected to rise at an annual rate of 5%. If the project costs Rs. 3,50,00,000, what is the internal rate of return over a project lifetime of 15 years? (8)

Syllabus

Module 1

Introduction - Basic Concept of Energy -Source of Solar Energy -Formation of the Atmosphere - Solar Spectrum. Solar Constant -Air Mass -Solar Time-Sun-Earth Angles- Solar Radiation-Instruments to Measure Solar Radiation-Pyrheliometer -Pyranometer - Sunshine Recorder -Solar Radiation on a Horizontal Surface - Extra-terrestrial Region.- Terrestrial Region -Solar Radiation on an Inclined Surface -Conversion Factors -Total Solar Radiation on an Inclined/Tilted Surface -Monthly Average Daily Solar Radiation on Inclined Surfaces .

Module 2

Solar Thermal system-Principle of Conversion of Solar Radiation into Heat, -Solar thermal collectors -General description and characteristics -Flat plate collectors -Heat transfer processes -Solar concentrators (parabolic trough, parabolic dish, Central Tower Collector) - performance evaluation. Applications -Solar heating system, Air conditioning and Refrigeration system, Pumping system, solar cooker, Solar Furnace, Solar Greenhouse - Design of solar water heater

Module 3

Solar PV Systems-Introduction -Fundamentals of Semiconductor and Solar Cells - Photovoltaic Effect -Solar Cell (Photovoltaic) Materials - Basic Parameters of the Solar Cell - Generation of Solar Cell (Photovoltaic) Materials-Photovoltaic (PV) Module and PV Array - Single-Crystal Solar Cell Module, Thin-Film PV Modules, III-V Single Junction and Multifunction PV Modules-Emerging and New PV Systems -Packing Factor of the PV Module - Efficiency of the PV Module -Energy Balance Equations for PV Modules -Series and Parallel Combination of PV Modules.- Effect of shadowing-MPPT Techniques-P&O , incremental conductance method-Maximum Power Point Tracker (MPPT) using buck-boost converter.

Module 4

Solar PV Systems -stand-alone and grid connected -Design steps for a Stand-Alone system - Storage batteries and Ultra capacitors. Design PV powered DC fan and pump without battery- Design of Standalone System with Battery and AC or DC Load. A Grid Interactive PV System - Phase , Frequency Matching and Voltage Consideration - Operation of a Grid Interactive Inverter -Overview of IEEE -2018 Standard for Interconnecting Distributed Resources with Electric Power Systems

Module 5

Protection Against Islanding and Reverse Power Flow - AC Modules Design of EMI Filters. Overcurrent protection of solar PV power system, Selective fuse links for PV String protection, PV fuse selection flow chart, Fuse rating for PV Applications.

Life cycle costing, Growth models, Annual payment and present worth factor, payback period, LCC with examples. Introduction to simulation software for solar PV system design. *(An assignment can be given corresponding to CO2, CO3 and CO4 utilizing the simulation tools)*

Text book:

1. D.P. Kothari, M Jamil. Grid Integration of Solar Photovoltaic Systems, CRC Press 2018
2. Chetan Singh Solanki, Solar Photovoltaics: Fundamentals, Technologies And Applications 3rd Edition, PHI
3. G.N. Tiwari: Solar Energy-Fundamentals, Design, Modelling and Applications, Narosa Publishers,2002
4. A.A.M. Saigh(Ed): Solar Energy Engineering, Academic Press, 1977

References:

1. Masters, Gilbert M., Renewable and efficient electric power systems, John Wiley & Sons, Inc., Hoboken, New Jersey, 2004.
2. A. Duffie and W.A. Beckman: Solar Energy Thermal Processes, J. Wiley, 1994.
3. Thomas E. Kissell, David M. Buchla, Thomas L. Floyd Renewable energy systems, Pearson 2017
4. G. N. Tiwari,ArvindTiwari,Shyam, Handbook of Solar Energy: Theory, Analysis and Applications, springer,2016.
5. F. Kreith and J.F. Kreider: Principles of Solar Engineering, McGraw Hill, 1978
6. Khan B. H., Non-Conventional Energy Resources, Tata McGraw Hill, 2009.
7. D.P.Kothari, K.C.Singal, RakeshRanjan, *Renewable Energy Sources and Emerging Technologies*, Prentice Hall of India, New Delhi, 2009.
8. Rao S. and B. B. Parulekar, Energy Technology, Khanna Publishers, 1999.
9. Sab S. L., Renewable and Novel Energy Sources, MI. Publications, 1995.
10. Sawhney G. S., Non-Conventional Energy Resources, PHI Learning, 2012.
11. Abbasi S. A. and N. Abbasi, Renewable Energy Sources and Their Environmental Impact, Prentice Hall of India, 2001.
12. Boyle G. (ed.), Renewable Energy -Power for Sustainable Future, Oxford University Press, 1996.
13. Johansson T. B., H. Kelly, A. K. N. Reddy and R. H. Williams, Renewable Energy – Sources for Fuel and Electricity, Earth scan Publications, London, 1993.
14. Tara Chandra Kandpal, Hari Prakash Garg, Financial evaluation of renewable energy technologies, Mac Millam India Limited.,2003.
15. "IEEE Application Guide for IEEE Std 1547(TM), IEEE Standard for Interconnecting Distributed Resources with Electric Power Systems," in IEEE Std 1547.2-2008 , vol., no., pp.1-217, 15 April 2009, doi: 10.1109/IEEESTD.2008.4816078

Course Contents and Lecture Schedule:

No	Topic	No. of Lectures
1	Solar energy (7 hours)	
1.1	Introduction - Basic Concept of Energy -Source of Solar Energy - Formation of the Atmosphere - Solar Spectrum.	1
1.2	Solar Constant -Air Mass -Solar Time-Sun–Earth Angles-Solar Radiation-Instruments to Measure Solar Radiation-Pyrheliometer – Pyranometer -Sunshine Recorder	2
1.3	Solar Radiation on a Horizontal Surface –Extra-terrestrial Region.- Terrestrial Region -Solar Radiation on an Inclined Surface -Conversion Factors	2
1.4	Total Solar Radiation on an Inclined/Tilted Surface -Monthly Average Daily Solar Radiation on Inclined Surfaces.	2
2	Solar Thermal Systems (6 hours)	
2.1	Principle of Conversion of Solar Radiation into Heat, –Solar thermal collectors –General description and characteristics	1
2.2	Flat plate collectors –Heat transfer processes –Solar concentrators (parabolic trough, parabolic dish, Central Tower Collector) – performance evaluation.	2
2.3	Applications -Solar heating system, Air conditioning and Refrigeration system	1
2.4	Pumping system, solar cooker, Solar Furnace, Solar Greenhouse	1
2.5	Design of solar water heater	1
3	Solar PV systems (7 Hours)	
3.1	Introduction -Fundamentals of Semiconductor and Solar Cells - Photovoltaic Effect -Solar Cell (Photovoltaic) Materials - Basic Parameters of the Solar Cell -Generation of Solar Cell (Photovoltaic) Materials	2
3.2	Photovoltaic (PV) Module and PV Array - Single-Crystal Solar Cell Module, Thin-Film PV Modules, III–V Single Junction and Multijunction PV Modules -Emerging and New PV Systems	1
3.3	Packing Factor of the PV Module - Efficiency of the PV Module - Energy Balance Equations for PV Modules	1
3.4	Series and Parallel Combination of PV Modules.- Effect of shadowing-	1
3.5	MPPT Techniques-P&O , incremental conductance methd-Maximum Power Point Tracker (MPPT) using buck-boost converter.	2

4	Stand Alone and Grid integrated PV System (9 Hours)	
4.1	Solar PV Systems –stand-alone and grid connected -Design steps for a Stand-Alone system –Storage batteries and Ultra capacitors.	2
4.2	Design PV powered DC fan and pump without battery	2
4.3	Design of Standalone System with Battery and AC or DC Load.	2
4.4	A Grid Interactive PV System - Phase , Frequency Matching and Voltage Consideration – Operation of a Grid Interactive Inverter	2
4.5	IEEE Standard for Interconnecting Distributed Resources with Electric Power Systems	1
5	GIPV System Protection and LCC (7)	
5.1	Protection Against Islanding and Reverse Power Flow	1
5.2	AC Modules Design of EMI Filters. .	1
5.3	Overcurrent protection of solar PV power system, Selective fuse links for PV String protection, PV fuse selection flow chart, Fuse rating for PV Applications	2
5.4	Life cycle costing, Growth models, Annual payment and present worth factor, payback period of solar PV system, LCC with examples.	2
5.5	Introduction to simulation software for solar PV system design like PV syst, PV SOL etc.	1

Estd.



2014

Assessment Pattern

Bloom's Category	Continuous Assessment Tests		End Semester Examination
	1	2	
Remember (K1)	10	10	20
Understand (K2)	30	30	60
Apply (K3)	10	10	20
Analyse (K4)			
Evaluate (K5)	-	-	-
Create (K6)	-	-	-

End Semester Examination Pattern : There will be two parts; Part A and Part B. Part A contain 10 questions with 2 questions from each module, having 3 marks for each question. Students should answer all questions. Part B contains 2 questions from each module of which student should answer anyone. Each question can have a maximum 2 sub-divisions and carry 14 marks.

Course Level Assessment Questions**Course Outcome 1 (CO1):**

1. Explain different characteristics of transducers (K2)
2. Selection of transducers for various applications (K2, K3)

Course Outcome 2 (CO2):

1. Explain amplifier circuits used for signal conditioning in instrumentation systems (K2)
2. Explain different types of actuators used in instrumentation system (K2)

Course Outcome 3 (CO3):

1. Explain the protocols used in data transmission for instrumentation system (K2)
2. Describe the differences between traditional instruments and virtual instruments (K2)

Course Outcome 4 (CO4):

1. Describe the hardware details of programmable logic controllers (K2)
2. Implement logic gates and simple operations using PLC (K2, K3)

Course Outcome 5 (CO5):

1. Explain the architecture and protocols involved in SCADA systems (K2)
2. Describe the architecture of Distributed Control Systems (K2)

Model Question Paper**QP CODE:**

PAGES:2

Reg. No: _____

Name: _____

**APJ ABDUL KALAM TECHNOLOGICAL UNIVERSITY EIGHTH SEMESTER
B. TECH DEGREE EXAMINATION,
MONTH & YEAR
Course Code: EET468**

Course Name: INDUSTRIAL INSTRUMENTATION AND AUTOMATION

Max. Marks: 100

Duration: 3 Hours

PART A

Answer all questions. Each Question Carries 3 mark

1. State the factors to be considered while selecting a transducer for a specific application.
2. Explain different modes of operation of hotwire anemometer.
3. How can a log amplifier be used for signal conditioning?
4. Describe the working of electrical actuators
5. Compare Profibus and Fieldbus used in data transmission
6. List the advantages of virtual instrumentation systems
7. Implement basic gate operations using PLC ladder logic
8. Write a PLC program to obtain a delay of 10ms for process control
9. List the main components associated with SCADA Systems.
10. Explain different protocols used in SCADA communication

PART B

Answer any one full question from each module. Each question carries 14 marks.

Module 1

11. a) With the help of a diagram explain the process control loop. (10)
b) Explain second order time response of sensor. (4)
12. a) Explain the principal and operation of variable reluctance tachometer (7)
b) Discuss the working principle of Capacitive differential pressure measurement (7)

Module 2

13. a) Explain different types of actuators. (10)
b) Explain the working principle of charge amplifier. (4)
14. a) Explain the operation of Instrumentation amplifier (7)
b) How phase sensitive detectors can be employed for phase measurement. (7)

Module 3

15. a) Explain the architecture of Virtual instrumentation system (10)
b) Describe the concept of graphical programming (4)
16. a) Explain the different types of communication networks used for data collection and control in industrial applications (10)
b) Explain Field bus. (4)

Module 4

17. Devise a ladder program to switch on a pump for 100 s. It is then to be switched off, and a heater switched on for 50 s. Then the heater is switched off, and another pump is used to empty the water. (14)
18. Draw a block diagram of a PLC showing the main functional items and how buses link them, explaining the functions of each block (14)

Module 5

19. a) With neat diagram explain the architecture of Distributed control system (7)
b) Describe in detail protocols for SCADA communication (7)
20. a) Explain role of MTU in SCADA communication (4)
b) With neat diagram explain the architecture of SCADA system (10)

Syllabus		
Module	Contents	Hours
I	<p>Sensors and Transducers</p> <p>Introduction to Process Control - block diagram of the process control loop, definition of elements. Sensor time response - first and second-order responses.</p> <p>Transducers- Characteristics and Choice of the transducer. Applications of Transducers- Displacement measurement using Resistance Potentiometer- Capacitive differential pressure measurement, Flow measurement using Hotwire anemometer, speed measurement- Variable reluctance tachometers, Phase measurement- Analog and digital</p>	7
II	<p>Signal conditioning circuits and Final control</p> <p>Electronic amplifiers-Differential Amplifier, Instrumentation Amplifiers, Precision rectifiers, Log amplifiers, Carrier Amplifiers, Lock-In Amplifiers, Isolation Amplifiers, Charge amplifiers, Phase-sensitive detectors. Final control operation- signal conversion- actuators- control elements, Actuators- Electrical – Pneumatic- Hydraulic, Control elements-mechanical- electrical- fluid valves</p>	6
III	<p>Data transmission and Virtual instrumentation system</p> <p>Cable transmission of analog and digital data, Fiber optic data transmission, Pneumatic transmission. Process control Network- Functions- General characteristics- Fieldbus and Profibus, radio-wireless communication, WLAN architecture.</p> <p>Virtual instrumentation system: The architecture of virtual instruments – Virtual instruments and traditional instruments – concepts of graphical programming</p>	7
IV	<p>Programmable logic controllers (PLC)</p> <p>Programmable logic controllers- Organization- Hardware details- I/O- Power supply- CPU- Standards Programming aspects- Ladder programming- realization of AND, OR logic, the concept of latching, Introduction to Timer/Counters, Exercises based on Timers and Counters.</p>	7
V	<p>SCADA and DCS systems</p> <p>SCADA: Introduction, SCADA Architecture, Common System Components, Supervision and Control, HMI, RTU and Supervisory Stations, Protocols-IEC 60870-5-101 and DNP3.</p> <p>DCS: Introduction, DCS Architecture, Control modes.</p>	5

Text Books

1. Curtis D Johnson , “Process Control Instrumentation Technology”, PHI Learning Pvt Ltd New Delhi, 1997
2. Doebelin E.O, “Measurement Systems: Application and Design”, Fourth Edition, McGraw Hill, Newyork, 1992
3. DVS. Murty, “Transducers and Instrumentation”, Second Edition, PHI Learning Pvt Ltd New Delhi, 2013
4. Jovitha Jerome, “Virtual instrumentation using LabVIEW”, Prentice Hall of India, 2010.
5. William Bolton, “Programmable Logic Controllers”, Fifth edition, ELSEVIER INDIA Pvt Ltd New Delhi, 2011
6. Stuart A. Boyer, "SCADA: Supervisory Control and Data Acquisition", Fourth edition, International Society of Automation, 2010

References:

1. G.K.McMillan, ‘Process/Industrial Instrument and control and hand book’ McGraw Hill, New York,1999
2. Michael P .Lucas, ‘Distributed Control system’, Van Nastrant Reinhold Company, New York
3. Patranabis, D., ‘Principles of Industrial Instrumentation’, Second Edition Tata McGraw Hill Publishing Co. Ltd. New Delhi
4. Robert B. Northrop, ‘Introduction to instrumentation and measurements’, CRC, Taylor and Francis 2005

Course Contents and Lecture Schedule:

No	Topic	No. of Lectures
1	Sensors and Transducers (07 hours)	
1.1	Introduction to Process Control - block diagram of the process control loop, definition of elements. Sensor time response - first and second-order responses.	2
1.2	Transducers- Characteristics and Choice of transducer.	1
1.3	Applications of Transducers- Displacement measurement using Resistance Potentiometer- Capacitive differential pressure measurement	2
1.4	Flow measurement using Hotwire anemometer, speed measurement- Variable reluctance tachometers, Phase measurement- Analog and digital	2
2	Signal conditioning circuits and Final control (06 hours)	
2.1	Electronic amplifiers-Differential Amplifier, Instrumentation Amplifiers, Precision rectifiers, Log amplifiers, Carrier Amplifiers	2
2.2	Lock-In Amplifiers, Isolation Amplifiers, Charge amplifiers, Phase sensitive detectors	2

2.3	Final control operation- signal conversion- actuators- control elements Actuators- Electrical – Pneumatic- Hydraulic Control elements-mechanical- electrical- fluid valves	2
3	Data transmission and Virtual instrumentation system(07Hours)	
3.1	Cable transmission of analog and digital data, Fiber optic data transmission, Pneumatic transmission	2
3.2	Process control Network- Functions- General characteristics- Fieldbus and Profibus, radio and wireless communication and WLAN	2
3.3	Virtual instrumentation system: architecture of virtual instruments – Virtual instruments and traditional instruments – concepts of graphical programming	3
4	Automation using PLC (07 Hours)	
4.1	Programmable logic controllers- Introduction	1
4.2	Organisation and Hardware details - I/O- Power supply- CPU etc.	2
4.3	Standards Programming aspects- Ladder programming- realization of AND, OR logic, concept of latching,	2
4.4	Introduction to Timer/Counters, Exercises based on Timers and Counters	2
5	Automation using SCADA and DCS Systems (05 Hours)	
5.1	Introduction to SCADA, its Architecture and Common System Components	1
5.2	Supervision and Control, HMI, RTU and Supervisory Stations, Protocols-IEC 60870-5-101 and DNP3.	3
5.3	DCS: Introduction, DCS Architecture, Control modes.	1



CODE	COURSE NAME	CATEGORY	L	T	P	CREDIT
EET478	BIG DATA ANALYTICS	PEC	2	1	0	3

Preamble: This course is offered to introduce fundamental algorithmic ideas in processing data. The preliminary concepts of Hadoop and Map Reduce are included as part of this course.

Prerequisite: Nil

Course Outcomes: After the completion of the course the student will be able to

CO 1	Explain the key concepts of data science.
CO 2	Describe big data and use cases from selected business domains
CO 3	Perform big data analytics using Hadoop and related tools like Pig and Hive.
CO 4	Perform preliminary analytics using R language on simple data sets.
CO 5	Differentiate various learning approaches in machine learning to process data, and to interpret the concepts of supervised and unsupervised learning

Mapping of course outcomes with program outcomes

	PO 1	PO 2	PO 3	PO 4	PO 5	PO 6	PO 7	PO 8	PO 9	PO 10	PO 11	PO 12
CO 1	3											2
CO 2	3											2
CO 3	3	2	2		3							2
CO 4	3	2			3							2
CO 5	3	2			3							2

Assessment Pattern

Bloom's Category	Continuous Assessment Tests		End Semester Examination
	1	2	
Remember	15	15	30
Understand	25	25	50
Apply	10	10	20
Analyse			
Evaluate			
Create			

Mark distribution

Total Marks	CIE	ESE	ESE Duration
150	50	100	3 hours

Continuous Internal Evaluation Pattern:

Attendance	: 10 marks
Continuous Assessment Test (2 numbers)	: 25 marks
Assignment/Quiz/Course project	: 15 marks

End Semester Examination Pattern: There will be two parts; Part A and Part B. Part A contain 10 questions with 2 questions from each module, having 3 marks for each question. Students should answer all questions. Part B contains 2 questions from each module of which student should answer any one. Each question can have maximum 2 sub-divisions and carry 14 marks.

Course Level Assessment Questions**Course Outcome 1 (CO1):**

1. Explain the main categories of data that we come across in data science. (K1)
2. Summarize distributed file system with examples. (K1)
3. List the significance of data science. (K2)

Course Outcome 2 (CO2)

1. What are the three characteristics of Big Data, and what are the main considerations in processing Big Data?(K1)
2. Explain Big Data Analytics Lifecycle. (K1)
3. Explain Apache Hadoop ecosystem. (K1)

Course Outcome 3(CO3):

1. Demonstrate the map reduce execution flow to perform word count on data set.(K3)
2. Explain the stages of Map Reduce. (K2)
3. Write short notes on Pig and Hive. (K1)

Course Outcome 4 (CO4):

1. How do you list the preloaded datasets in R? (K2)
2. Use R to find the highest common factor of two numbers. (K3)
3. Why is R useful for data science? (K2)

Course Outcome 5 (CO5):

1. Mention the difference between Data Mining and Machine learning? (K2)
2. What are the different Algorithm techniques in Machine Learning? (K2)
3. Give a popular application of machine learning that you see on day-to-day basis? (K2)

Model Question Paper**QP CODE:****Reg No:** _____**PAGES:3****Name :** _____**APJ ABDUL KALAM TECHNOLOGICAL UNIVERSITY EIGHTH SEMESTER****B.TECH DEGREE EXAMINATION, MONTH & YEAR****Course Code: EET478****Course Name: BIG DATA ANALYTICS****Max. Marks: 100 Duration: 3 Hours****(2019-Scheme)****PART A****(Answer all questions, each question carries 3 marks)**

1. List any six Data Science applications.
2. Briefly explain the data transformation step in the process of Data Science.
3. Explain the important characteristics of Bigdata.
4. List the functions of Namenode in HDFS.
5. Identify the need of MapReduce Partitioner in Hadoop.
6. Differentiate between Hadoop MapReduce and Pig.
7. In R how missing values are represented.
8. How you can import Data in R.
9. Discuss any four examples of machine learning applications.
10. Describe the applications of clustering in various domains.

(10x3 = 30 marks)**PART B****(Answer one full question from each module, each question carries 14 marks)****MODULE I**

- 11.a) Illustrate with an example different stages of data science project.
 - b. Categorise the different roles associated with a data analysis project. (10+4 =14 marks)
- Or
12. a) Explain the data cleansing subprocess of data science process.
 - b) Discuss in detail about Exploratory Data analysis. (8+6 =14 marks)

MODULE II

- 13.a) Explain the core components of Apache Hadoop.
 - b) Write short note on YARN. (8+6 = 14 marks)
- Or
14. a) Explain read and write operations in HDFS.
 - b) What are Blocks in HDFS Architecture. (10+4 = 14 marks)

MODULE III

- 15.a) With a neat diagram, explain MapReduce architecture?
 - b) Describe the stages of MapReduce with an example. (5+9 = 14 marks)
- Or
16. a) Write short note on Pig and HIVE.
 - b) Compare NoSQL & RDBMS (10+4 = 14 marks)

MODULE IV

- 17.a) Explain data frames in R. Illustrate attach (), detach () and search () functions in R.
b) Explain any three functions in R to visualize a single variable. (8+6 = 14 marks)

Or

18. a) What are the data structures in R that is used to perform statistical analyses and create graphs?
b) Mention how you can produce co-relations and covariances with example? (9+5 = 14 marks)

MODULE V

- 19.a) Distinguish between classification and regression with an example.
b) Describe in detail with examples (i) Supervised Learning(ii) Unsupervised Learning (iii) Reinforcement Learning. (5+9 = 14 marks)

Or

20. a) Is regression a supervised learning technique? Justify your answer. Compare regression with classification with examples.?
b) Illustrate K means clustering algorithm with an example.? (8+6 = 14 marks)

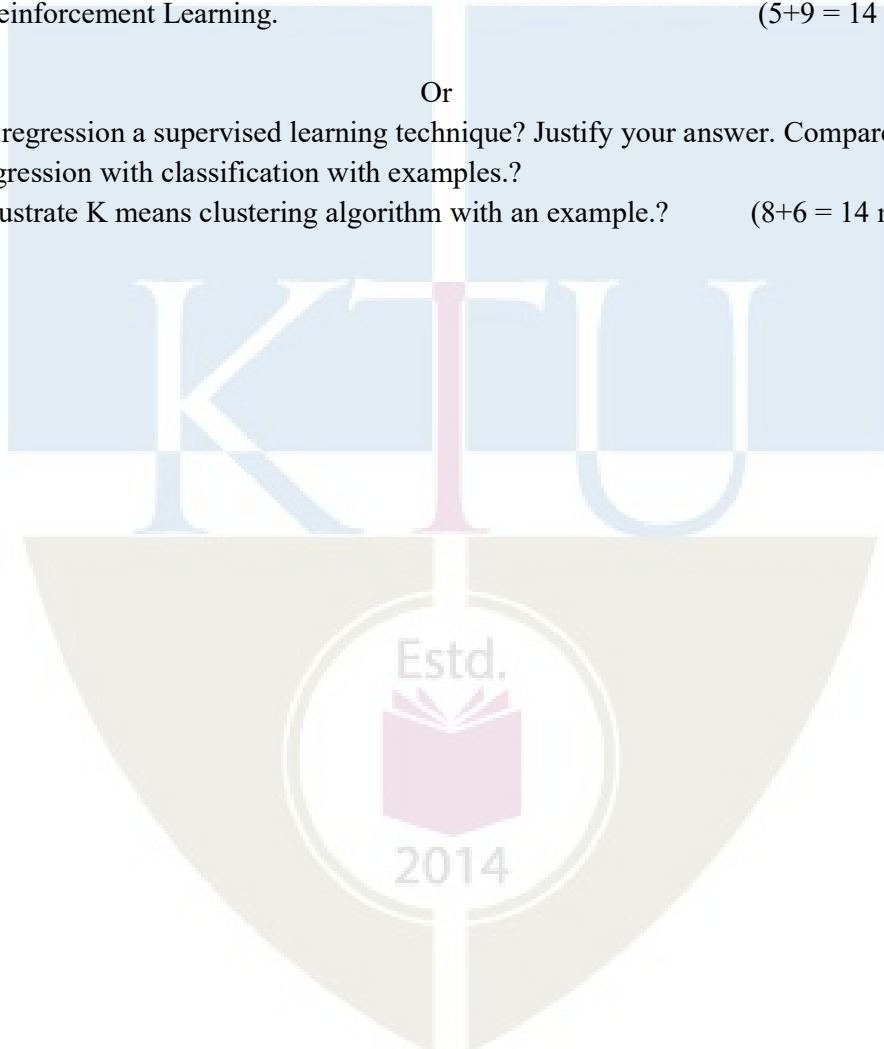

Syllabus

Module I-Data science in a big data world: Benefits and uses of data science and big data-Facets of data-the big data ecosystem and data science-Data science process-roles-stages in data science project- Defining research goals-Retrieving data-Cleansing, integrating, and transforming data- Data Exploration-Data modelling - Presentation and automation.

(6 hours)

Module II-Big Data Overview–the five V’s of big data-State of the Practice in Analytics-Examples of Big Data Analytics-Apache Hadoop and the Hadoop Ecosystem-HDFS-Design of HDFS, HDFS Concepts-Daemons-Reading and Writing Data-Managing File system Metadata- Map Reduce-The Stages of Map Reduce -Introducing Hadoop Map Reduce-Daemons-YARN (8 hours)

Module III-Analysing the Data with Hadoop using Map and Reduce-Developing a Map Reduce Application-Anatomy of a Map Reduce Job- Scheduling-Shuffle and Sort - Task execution.

Big data Management Tools: PIG- : Introduction to PIG, Execution Modes of Pig,Pig Latin, HIVE: Hive Architecture, HIVEQL, Introduction to NoSQL. (Introduction only)

(7 hours)

Module IV -Review of Basic Analytic methods using R- Introduction to R -Data Import and Export -Attribute and Data Types - ordered and unordered factors-arrays and matrices-lists and data frames -Descriptive Statistics-Exploratory Data Analysis-Dirty Data-Visualizing a Single Variable-Examining Multiple Variables-statistical models in R-Graphical Procedures-High-level plotting commands-Low-level plotting commands.

(7 hours)

Module V -Machine learning -Introduction to Machine Learning, Examples of Machine Learning applications-Supervised Learning- Regression – Single variable, Multi variable-Classification – Logistic Regression- Unsupervised Learning - Clustering: K-means-Reinforcement Learning-Model Selection and validation-k-Fold Cross Validation-Measuring classifier performance- Precision, recall

(7 hours)

Text/ Reference Books

1. Davy Cielen, Arno D. B. Meysman, and Mohamed Ali ,“Introducing Data Science - Big data, machine learning, and more, using Python tools” , Dreamtech Press 2016
2. Michael Minelli, Michelle Chambers, and AmbigaDhiraj, "Big Data, Big Analytics: Emerging Business Intelligence and Analytic Trends for Today's Businesses", Wiley,2013
3. EMC Education Services, “Data Science and Big Data Analytics: Discovering, Analyzing, Visualizing and Presenting Data”, Wiley ,January 2015
4. Tom White,"Hadoop: The Definitive Guide", Third Edition, O'Reilley,2012.
5. Eric Sammer,"Hadoop Operations",O'Reilly Media, Inc ,2012
6. E. Capriolo, D. Wampler, and J. Rutherglen, "Programming Hive", O'Reilley, 2012.
7. "Programming Pig", Alan Gates, O’Reilley,2011.

8. Ethem Alpaydin, “Introduction to Machine Learning (Adaptive Computation and Machine Learning)”, MIT Press, 2004.
9. Shai Shalev-Shwartz, Shai Ben-David, “Understanding Machine Learning: From Theory to Algorithms”, Cambridge University Press, 2014
10. Christopher Bishop, “Pattern Recognition and Machine Learning”, Springer, 2007.
11. Matloff, Norman,” The art of R programming: A tour of statistical software design”. No Starch Press, 2011.
12. Crawley, Michael J. The R book. John Wiley & Sons, 2012.
13. Sourabh Mukherjee, Amit Kumar Das and Sayan Goswami, “ Big Data Simplified”, Pearson, 1st edition, 2019.
14. Murtaza Haider, “Getting Started with Data Science”, First Edition, Kindle Edition, IBM Press, 2015.
15. Thomas Erl, Wajid Khattak and Paul Buhler “ Big Data Fundamentals: Concepts, Drivers and Techniques”, Prentice Hall, Pearson Service, 2016.

Course Contents and Lecture Schedule

No	Topic	No. of Lectures
1	Module I Data science in a big data world	6 hours
1.1	Data science in a big data world, Benefits and uses of data science and big data-Facets of data	1
1.2	the big data ecosystem and data science-Data science process-roles	1
1.3	Defining research goals-Retrieving data	1
1.4	Cleansing, integrating, and transforming data	1
1.5	Data Exploration	1
1.6	Data modelling - Presentation and automation.	1
2	Module II -Big Data Overview	8 hours
2.1	the five V’s of big data-State of the Practice in Analytics-Examples of Big Data Analytics	1
2.2	Apache Hadoop and the Hadoop Ecosystem- HDFS	2
2.3	Design of HDFS- HDFS Concepts-Daemons-Reading and Writing Data - Managing Filesystem Metadata	2
2.4	Map Reduce-The Stages of MapReduce -Introducing Hadoop MapReduce-Daemons	2
2.5	YARN	1
3	Module III - Analysing the Data with Hadoop	7 hours
3.1	Analysing the Data with Hadoop using Map and Reduce-Developing a Map Reduce Application	1
3.2	Anatomy of a Map Reduce Job- Scheduling-Shuffle and Sort - Task execution	2
3.3	Bigdata Management Tools: PIG- : Introduction to PIG, Execution Modes of Pig,Pig Latin	2
3.4	HIVE: Hive Architecture, HIVEQL,	1

3.5	Introduction to NoSQL	1
4	Module IV -Review of Basic Analytic methods using R	7 hours
4.1	Introduction to R -Data Import and Export -Attribute and Data Types - ordered and unordered factors-arrays and matrices	2
4.2	lists and data frames -Descriptive Statistics	1
4.3	Exploratory Data Analysis -Dirty Data	1
4.4	Visualizing a Single Variable-Examining Multiple Variables	1
4.5	statistical models in R-	1
4.6	Graphical Procedures-High-level plotting commands-Low-level plotting commands	1
5	Module V - Machine learning	7 hours
5.1	Introduction to Machine Learning, Examples of Machine Learning applications	1
5.2	Supervised Learning- Regression – Single variable, Multi variable	2
5.3	Classification – Logistic Regression	1
5.4	Unsupervised Learning - Clustering: K-means	1
5.5	Model Selection and validation-k-Fold Cross Validation	1
5.6	Measuring classifier performance- Precision, recall	1

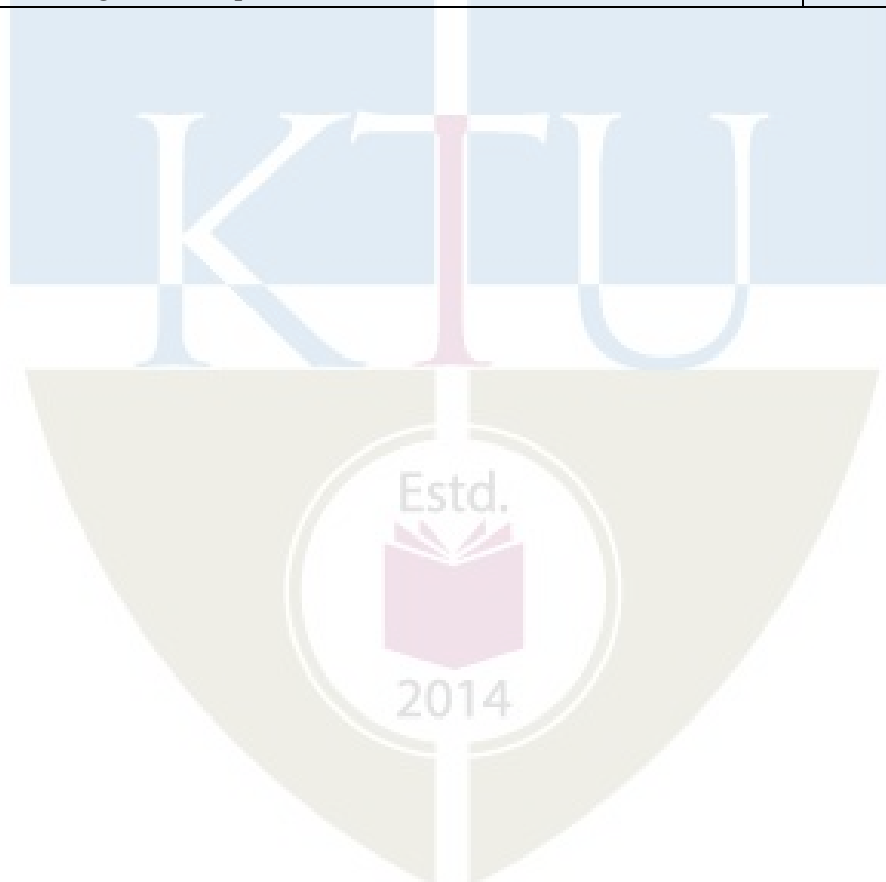

EET404	COMPREHENSIVE COURSE VIVA	CATEGORY	L	T	P	CREDIT
		PCC	1	0	0	1

Preamble: The objective of this Course viva is to ensure the basic knowledge of each student in the most fundamental core courses in the curriculum. The viva voce shall be conducted based on the core subjects studied from third to eighth semester. This course helps the learner to become competent in placement tests and other competitive examinations.

Guidelines

1. The course should be mapped with a faculty and classes shall be arranged for practicing questions based on the core courses listed in the curriculum.
2. The viva voce will be conducted by the same three member committee assigned for final project phase II evaluation. It comprises of Project coordinator, expert from Industry/research Institute and a senior faculty from a sister department.
3. The pass minimum for this course is 25.
4. The mark will be treated as internal and should be uploaded along with internal marks of other courses.
5. Comprehensive Viva should be conducted along with final project evaluation by the three member committee.

Mark Distribution

Total marks: 50, only CIE, minimum required to pass : 25 Marks



EED416	PROJECT PHASE II	CATEGORY	L	T	P	CREDIT
		PWS	0	0	12	4

Preamble: The course ‘Project Work’ is mainly intended to evoke the innovation and invention skills in a student. The course will provide an opportunity to synthesize and apply the knowledge and analytical skills learned, to be developed as a prototype or simulation. The project extends to 2 semesters and will be evaluated in the 7th and 8th semester separately, based on the achieved objectives. One third of the project credits shall be completed in 7th semester and two third in 8th semester. It is recommended that the projects may be finalized in the thrust areas of the respective engineering stream or as interdisciplinary projects. Importance should be given to address societal problems and developing indigenous technologies.

Course Objectives

- To apply engineering knowledge in practical problem solving.
- To foster innovation in design of products, processes or systems.
- To develop creative thinking in finding viable solutions to engineering problems.

Course Outcomes [COs]: After successful completion of the course, the students will be able to:

CO1	Model and solve real world problems by applying knowledge across domains (Cognitive knowledge level: Apply).
CO2	Develop products, processes or technologies for sustainable and socially relevant applications (Cognitive knowledge level: Apply).
CO3	Function effectively as an individual and as a leader in diverse teams and to comprehend and execute designated tasks (Cognitive knowledge level: Apply).
CO4	Plan and execute tasks utilizing available resources within timelines, following ethical and professional norms (Cognitive knowledge level: Apply).
CO5	Identify technology/research gaps and propose innovative/creative solutions (Cognitive knowledge level: Analyze).
CO6	Organize and communicate technical and scientific findings effectively in written and oral forms (Cognitive knowledge level: Apply).

Mapping of course outcomes with program outcomes

	PO1	PO2	PO3	PO4	PO5	PO6	PO7	PO8	PO9	PO10	PO11	PO12
CO1	2	2	2	1	2	2	2	1	1	1	1	2
CO2	2	2	2		1	3	3	1	1		1	1
CO3									3	2	2	1
CO4					2			3	2	2	3	2
CO5	2	3	3	1	2							1
CO6					2			2	2	3	1	1

Abstract POs defined by National Board of Accreditation			
PO #	Broad PO	PO#	Broad PO
PO1	Engineering Knowledge	PO7	Environment and Sustainability
PO2	Problem Analysis	PO8	Ethics
PO3	Design/Development of solutions	PO9	Individual and team work
PO4	Conduct investigations of complex problems	PO0	Communication
PO5	Modern tool usage	PO11	Project Management and Finance
PO6	The Engineer and Society	PO12	Lifelong learning

PROJECT PHASE II

Phase 2 Targets

- In depth study of the topic assigned in the light of the report prepared under Phase - I;
- Review and finalization of the approach to the problem relating to the assigned topic.
- Preparing a detailed action plan for conducting the investigation, including teamwork.
- Detailed Analysis/ Modeling / Simulation/ Design/ Problem Solving/Experiment as needed.
- Final development of product/ process, testing, results, conclusions and future directions.
- Preparing a paper for Conference Presentation/ Publication in Journals, if possible.
- Presenting projects in Project Expos conducted by the University at the cluster level and/ or state level as well as others conducted in India and abroad.
- Filing Intellectual Property Rights (IPR) if applicable.
- Preparing a report in the standard format for being evaluated by the Department Assessment Board.
- Final project presentation and viva voce by the assessment board including the external expert.

Evaluation Guidelines & Rubrics

Total: 150 marks (Minimum required to pass: 75 marks).

- Project progress evaluation by guide: 30 Marks.
- Two interim evaluations by the Evaluation Committee: 50 Marks (25 marks for each evaluation).
- Final evaluation by the Final Evaluation committee: 40 Marks
- Quality of the report evaluated by the evaluation committee: 30 Marks

(The evaluation committee comprises HoD or a senior faculty member, Project coordinator and project supervisor. The final evaluation committee comprises of Project coordinator, expert from Industry/research/academic Institute and a senior faculty from a sister department).

Evaluation by the Guide

The guide/supervisor must monitor the progress being carried out by the project groups on regular basis. In case it is found that progress is unsatisfactory it should be reported to the Department Evaluation Committee for necessary action. The presence of each student in the group and their involvement in all stages of execution of the project shall be ensured by the guide. Project evaluation by the guide: 30 Marks. This mark shall be awarded to the students in his/her group by considering the following aspects:

Project Scheduling & Distribution of Work among Team members: Detailed and extensive Scheduling with timelines provided for each phase of project. Work breakdown structure well defined. (5)

Literature survey: Outstanding investigation in all aspects. (4)

Student's Diary/ Daily Log: The main purpose of writing daily diary is to cultivate the habit of documenting and to encourage the students to search for details. It develops the students' thought process and reasoning abilities. The students should record in the daily/weekly activity diary the day to day account of the observations, impressions, information gathered and suggestions given, if any. It should contain the sketches & drawings related to the observations made by the students. The daily/weekly activity diary shall be signed after every day/week by the guide. (7)

Individual Contribution: The contribution of each student at various stages. (9)

Completion of the project: The students should demonstrate the project to their respective guide. The guide shall verify the results and see that the objectives are met. (5)



EVALUATION RUBRICS for PROJECT Phase II: Interim Evaluation - 1

No.	Parameters	Marks	Poor	Fair	Very Good	Outstanding
2-a	Novelty of idea, and Implementation scope [CO5] [Group Evaluation]	5	The project is not addressing any useful requirement. The idea is evolved into a non-implementable one. The work presented so far is lacking any amount of original work by the team.	Some of the aspects of the proposed idea can be implemented. There is still lack of originality in the work done so far by the team. The project is a regularly done theme/topic without any freshness in terms of specifications, features, and/or improvements.	Good evidence of an implementable project. There is some evidence for the originality of the work done by the team . There is fresh specifications/features/improvements suggested by the team. The team is doing a design from fundamental principles, and there is some independent learning and engineering ingenuity.	The project has evolved into incorporating an outstandingly novel idea. Original work which is not yet reported anywhere else. Evidence for ingenious way of innovation which is also Implementable. Could be a patentable / publishable work.
			(0 – 1 Marks)	(2 – 3 Marks)	(4 Marks)	(5 Marks)
2-b	Effectiveness of task distribution among team members. [CO3] [Group Evaluation]	5	No task distribution of any kind. Members are still having no clue on what to do.	Task allocation done, but not effectively, some members do not have any idea of the tasks assigned. Some of the tasks were identified but not followed individually well.	Good evidence of task allocation being done, supported by project journal entries, identification of tasks through discussion etc. However, the task distribution seems to be skewed, and depends a few members heavily than others. Mostly the tasks are being followed by the individual members.	Excellent display of task identification and distribution backed by documentary evidence of team brainstorming, and project journal entries. All members are allocated tasks according to their capabilities, and as much as possible in an equal manner. The individual members are following the tasks in an excellent manner.
			(0 – 1 Marks)	(2 – 3 Marks)	(4 Marks)	(5 Marks)
2-c	Adherence to project schedule. [CO4] [Group Evaluation]	5	Little or no evidence of continued planning or scheduling of the project. The students did not stick to the plan what they were going to build nor plan on what materials / resources to use in the project. The students do not have any idea on the budget required even after the end of phase - I. No project journal kept or the journal.	There is some improvement in the primary plan prepared during phase I. There were some ideas on the materials /resources required, but not really thought out. The students have some idea on the finances required, but they have not formalized a budget plan. Schedules were not prepared. The project journal has no useful details on the project.	Good evidence of planning done and being followed up to a good extent after phase I. Materials were listed and thought out, but the plan wasn't followed completely. Schedules were prepared, but not detailed, and needs improvement. Project journal is presented but it is neither complete nor updated regularly.	Excellent evidence of enterprising and extensive project planning and follow-up since phase I. Continued use of project management/version control tool to track the project. Material procurement if applicable is progressing well. Tasks are updated and incorporated in the schedule. A well-kept project journal showed evidence for all the above, in addition to the interaction with the project guide.
			(0 - 1 Marks)	(2 - 3 Marks)	(4 Marks)	(5 Marks)

2-d	Interim Results. [CO6] [Group assessment]	5	There are no interim results to show.	The team showed some interim results, but they are not complete / consistent to the current stage, Some corrections are needed.	The interim results showed were good and mostly consistent/correct with respect to the current stage. There is room for improvement.	There were significant interim results presented which clearly shows the progress.
			(0 - 1 Marks)	(2 - 3 Marks)	(4 Marks)	(5 Marks)
2-e	Presentation [Individual assessment]	5	Very poor presentation and there is no interim results. The student has no idea about the project proposal.	Presentation is average, and the student has only a feeble idea about the team work.	Good presentation. Student has good idea about the team's project. The overall presentation quality is good.	Exceptionally good presentation. Student has excellent grasp of the project. The quality of presentation is outstanding.
			(0 - 1 Marks)	(2 - 3 Marks)	(4 Marks)	(5 Marks)
Phase-II Interim Evaluation - 1 Total Marks: 25						

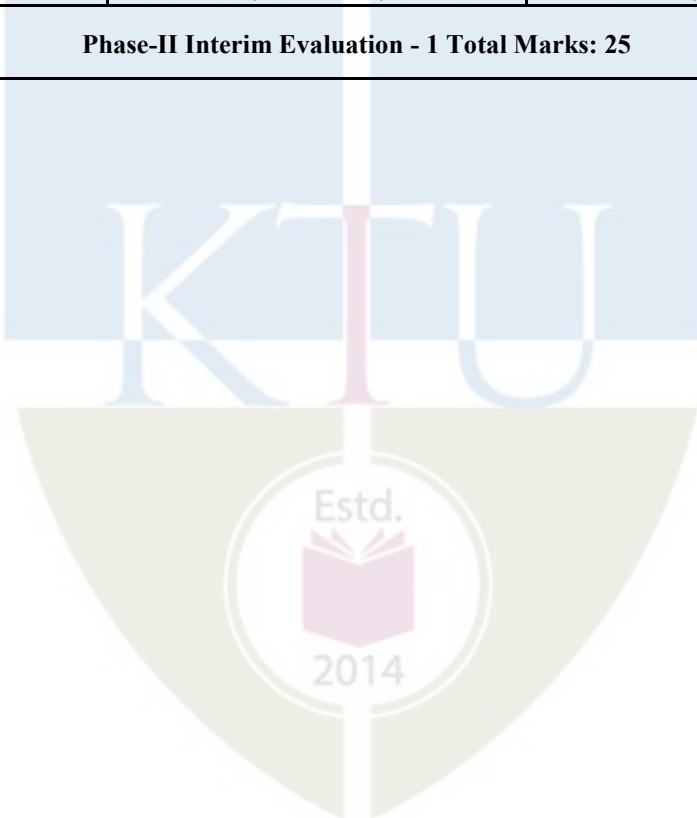

EVALUATION RUBRICS for PROJECT Phase II: Interim Evaluation – 2

No	Parameters	Marks	Poor	Fair	Very Good	Outstanding
2-f	Application of engineering knowledge [CO1] [Individual Assessment]	10	The student does not show any evidence of applying engineering knowledge on the design and the methodology adopted. The student's contribution in application of engineering knowledge in the project is poor.	The student appears to apply some basic knowledge, but not able to show the design procedure and the methodologies adopted in a comprehensive manner.	The student is able to show some evidence of application of engineering knowledge in the design and development of the project to good extent.	Excellent knowledge in design procedure and its adaptation. The student is able to apply knowledge from engineering domains to the problem and develop solutions.
			(0 – 3 Marks)	(4 – 6 Marks)	(7 - 9 Marks)	(10 Marks)
2-g	Involvement of individual members [CO3] [Individual Assessment]	5	No evidence of any Individual participation in the project work.	There is evidence for some amount of individual contribution, but is limited to some of the superficial tasks.	The individual contribution is evident. The student has good amount of involvement in core activities of the project.	Evidence available for the student acting as the core technical lead and has excellent contribution to the project.
			(0 - 1 Marks)	(2 - 3 Marks)	(4 Marks)	(5 Marks)
2-h	Results and inferences upon execution [CO5] [Group Assessment]	5	None of the expected outcomes are achieved yet. The team is unable to derive any inferences on the failures/issues observed. Any kind of observations or studies are not made.	Only a few of the expected outcomes are achieved. A few inferences are made on the observed failures/issues. No further work suggested.	Many of the expected outcomes are achieved. Many observations and inferences are made, and attempts to identify the issues are done. Some suggestions are made for further work.	Most of the stated outcomes are met. Extensive studies are done and inferences drawn. Most of the failures are addressed and solutions suggested. Clear and valid suggestions made for further work.
			(0 - 1 Marks)	(2 - 3 Marks)	(4 Marks)	(5 Marks)
2-i	Documentation and presentation. [CO6] [Individual assessment]	5	The individual student has no idea on the presentation of his/her part. The presentation is of poor quality.	Presentation's overall quality needs to be improved.	The individual's presentation performance is satisfactory.	The individual's presentation is done professionally and with great clarity. The individual's performance is excellent.
			(0 - 1 Marks)	(2 - 3 Marks)	(4 Marks)	(5 Marks)

Phase-II Interim Evaluation - 2 Total Marks: 25

EVALUATION RUBRICS for PROJECT Phase II: Final Evaluation

No	Parameters	Marks	Poor	Fair	Very Good	Outstanding
2-j	Engineering knowledge. [CO1] [Group Assessment]	10	The team does not show any evidence of applying engineering knowledge on the design and the methodology adopted.	The team is able to show some of the design procedure and the methodologies adopted, but not in a comprehensive manner.	The team is able to show evidence of application of engineering knowledge in the design and development of the project to good extent. There is scope for improvement.	Excellent knowledge in design procedure and its adaptation. The team is able to apply knowledge from engineering domains to the problem and develop an excellent solution.
			(0 – 3 Marks)	(4 – 6 Marks)	(7 - 9 Marks)	(10 Marks)
2-k	Relevance of the project with respect to societal and/or industrial needs. [Group Assessment] [CO2]	5	The project as a whole do not have any societal / industrial relevance at all.	The project has some relevance with respect to social and/or industrial application. The team has however made not much effort to explore further and make it better.	The project is relevant to the society and/or industry. The team is mostly successful in translating the problem into an engineering specification and managed to solve much of it.	The project is exceptionally relevant to society and/or industry. The team has made outstanding contribution while solving the problem in a professional and/or ethical manner.
			(0 - 1 Marks)	(2 - 3 Marks)	(4 Marks)	(5 Marks)
2-i	Innovation / novelty / Creativity [CO5] [Group Assessment]	5	The project is not addressing any useful requirement. The idea is evolved into a non-implementable one. The work presented so far is lacking any amount of original work by the team.	Some of the aspects of the proposed idea appears to be practical. There is still lack of originality in the work done. The project is a regularly done theme/topic without any freshness in terms of specifications, features, and/or improvements.	Good evidence of an implementable project. There is some evidence for the originality of the work done by the team. There is fresh specifications/features/improvements suggested by the team. The team is doing a design from fundamental principles, and there is some independent learning and engineering ingenuity. Could be translated into a product / process if more work is done.	The project has evolved into incorporating an outstandingly novel idea. Original work which is not yet reported anywhere else. Evidence for ingenious way of innovation which is also Implementable. Could be a patentable publishable work.
			(0 - 1 Marks)	(2 - 3 Marks)	(4 Marks)	(5 Marks)
2-m	Quality of results / conclusions / solutions. [CO1] [Group Assessment]	10	None of the expected outcomes are achieved. The team is unable to derive any inferences on the failures/issues observed. Any kind of observations or studies is not made.	Only a few of the expected outcomes are achieved. A few inferences are made on the observed failures/issues. No further work suggested.	Many of the expected outcomes are achieved. Many observations and inferences are made, and attempts to identify the issues are done. Some suggestions are made for further work.	Most of the stated outcomes are met. Extensive studies are done and inferences drawn. Most of the failures are addressed and solutions suggested. Clear and valid suggestions made for further work.
			(0 – 3 Marks)	(4 – 6 Marks)	(7 - 9 Marks)	(10 Marks)

2-n	Presentation - Part I Preparation of slides. [CO6] [Group Assessment].	5	The presentation slides are shallow and in a clumsy format. It does not follow proper organization.	Presentation slides follow professional style formats to some extent. However, its organization is not very good. Language needs to be improved. All references are not cited properly, or acknowledged. Presentation slides needs to be more professional.	Presentation slides follow a good style format and there are only a few issues. Organization of the slides is good. Most of references are cited properly. The flow is good and team presentation is neatly organized. Some of the results are not clearly shown. There is room for improvement.	The presentation slides are exceptionally good. Neatly organized. All references cited properly. Diagrams/Figures, Tables and equations are properly numbered, and listed. Results/ inferences clearly highlighted and readable.
			(0 - 1 Marks)	(2 - 3 Marks)	(4 Marks)	(5 Marks)
	Presentation - Part II: Individual Communication [CO6] [Individual Assessment].	5	The student is not communicating properly. Poor response to questions.	The student is able to explain some of the content. The student requires a lot of prompts to get to the idea. There are language issues.	Good presentation/ communication by the student. The student is able to explain most of the content very well. There are however, a few areas where the student shows lack of preparation. Language is better.	Clear and concise communication exhibited by the student. The presentation is outstanding. Very confident and tackles all the questions without hesitation. Exceptional traits of communicator.
			(0 - 1 Marks)	(2 - 3 Marks)	(4 Marks)	(5 Marks)
Phase-II Final Evaluation, Marks: 40						



EVALUATION RUBRICS for PROJECT Phase II: Report Evaluation

Sl. No.	Parameters	Marks	Poor	Fair	Very Good	Outstanding
2-o	Report [CO6]	30	The prepared report is shallow and not as per standard format. It does not follow proper organization. Contains mostly unacknowledged content. Lack of effort in preparation is evident. References are not cited. Unprofessional and inconsistent formatting.	Project report follows the standard format to some extent. However, its organization is not very good. Language needs to be improved. All references are not cited properly in the report. There is lack of formatting consistency.	Project report shows evidence of systematic documentation. Report is mostly following the standard style format and there are only a few issues. Organization of the report is good. Mostly consistently formatted. Most of references/sources are cited, acknowledged properly.	The report is exceptionally good. Neatly organized. All references cited properly. Diagrams/Figures, Tables and equations are properly numbered, and listed and clearly shown. Language is excellent and follows professional styles. Consistent formatting and exceptional readability.
			(0 - 11 Marks)	(12 - 18 Marks)	(19 - 28 Marks)	(29 - 30 Marks)
Phase - II Project Report Marks: 30						

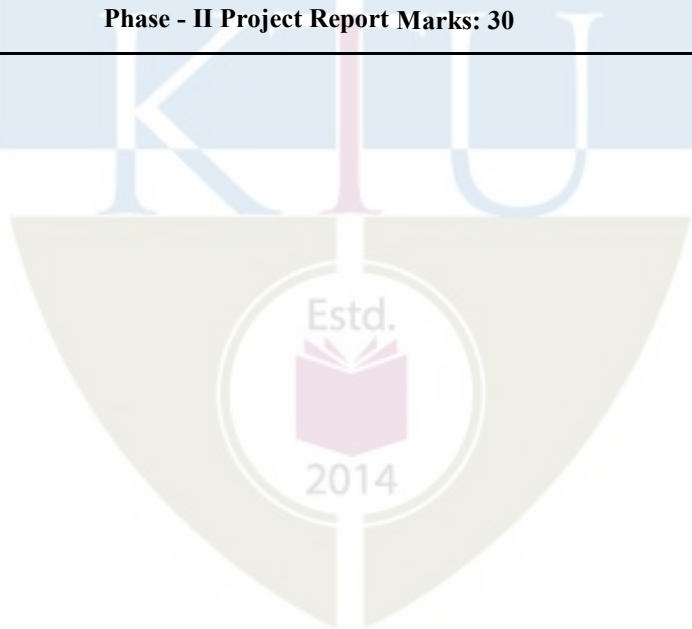

CODE	COURSE NAME	CATEGORY	L	T	P	CREDIT
EET401	ADVANCED CONTROL SYSTEMS	PCC	2	1	0	3

Preamble: This course aims to provide a strong foundation on advanced control methods for modelling, time domain analysis, and stability analysis of linear and nonlinear systems. The course also includes the design of feedback controllers and observers.

Prerequisite: EET 305 Signals and Systems, EET 302 Linear Control Systems

Course Outcomes: After the completion of the course the student will be able to:

CO 1	Develop the state variable representation of physical systems
CO 2	Analyse the performance of linear and nonlinear systems using state variable approach
CO 3	Design state feedback controller for a given system
CO 4	Explain the characteristics of nonlinear systems
CO 5	Apply the tools like describing function approach or phase plane approach for assessing the performance of nonlinear systems
CO 6	Apply Lyapunov method for the stability analysis of physical systems.

Mapping of course outcomes with program outcomes

	PO 1	PO 2	PO 3	PO 4	PO 5	PO 6	PO 7	PO 8	PO 9	PO 10	PO 11	PO 12
CO 1	3	3	-	-	-	-	-	-	-	-	-	2
CO 2	3	3	2	-	-	-	-	-	-	-	-	2
CO 3	3	3	3	-	-	-	-	-	-	-	-	2
CO 4	3	2	-	-	-	-	-	-	-	-	-	2
CO 5	3	3	2	-	-	-	-	-	-	-	-	2
CO 6	3	3	2	-	-	-	-	-	-	-	-	2

Assessment Pattern:

Total Marks	CIE marks	ESE marks	ESE Duration
150	50	100	03 Hrs

Bloom's Category	Continuous Assessment Tests		End Semester Examination
	1	2	
Remember (K1)	10	10	20
Understand (K2)	15	15	30
Apply (K3)	25	25	50
Analyse (K4)			
Evaluate (K5)			
Create (K6)			

End Semester Examination Pattern: There will be two parts; Part A and Part B.

Part A contains 10 questions with 2 questions from each module, having 3 marks for each question. Students should answer all questions.

Part B contains 2 questions from each module of which student should answer any one. Each question carries 14 marks and can have maximum 2 sub-divisions.

Course Level Assessment Questions:

Course Outcome 1 (CO1)

1. Derive the state model of an armature controlled DC servo motor. (K2, PO1)
2. Obtain the phase variable representation for the system with $G(s)=$

$$T(s) = \frac{2s^2 + s + 3}{s^3 + 6s^2 + 11s + 6} \quad (\text{K3, PO1, PO2})$$

3. Problems on deriving the state model of a given electrical circuit. (K2, PO1)
4. Problems on the conversion of Phase variable form to Canonical form. (K3, PO1, PO2)

Course Outcome 2 (CO2):

1. Obtain the time response $y(t)$ of the homogeneous system:

$$\dot{X} = \begin{bmatrix} -1 & 1 \\ -2 & -3 \end{bmatrix} x, \quad y = [1 \quad 1]x \quad \text{and} \quad x(0)^T = [1 \quad 0] \quad (\text{K3, PO1, PO2})$$

2. Determine the transfer function for the system with the state model:

$$\dot{X} = \begin{bmatrix} -2 & 1 \\ -3 & -2 \end{bmatrix} x + \begin{bmatrix} 1 \\ 1 \end{bmatrix} u; \quad y = [1 \quad 1]x \quad (\text{K3, PO1, PO2})$$

3. Determine the controllability of the following state model:

$$\dot{x} = \begin{bmatrix} 1 & 0 & 0 \\ 0 & 0 & 2 \\ 0 & -1 & -5 \end{bmatrix} x + \begin{bmatrix} 0 \\ 0 \\ 1 \end{bmatrix} u \quad (\text{K3, PO1, PO2, PO3})$$

Course Outcome 3(CO3):

1. Design a state feedback controller for the following system such that the closed loop poles are placed at: $-1 \pm j2$ and -12 .

$$\dot{x} = \begin{bmatrix} 0 & 1 & 0 \\ 0 & -1 & 2 \\ 0 & -1 & -3 \end{bmatrix} x + \begin{bmatrix} 0 \\ 0 \\ 1 \end{bmatrix} u \quad (\text{K3, PO1, PO2, PO3})$$

2. Design problems on State observer. (K3, PO1, PO2, PO3)

Course Outcome 4 (CO4):

1. Explain the linearization concept and assumptions made referred to Describing Function analysis. (K1, PO1)
2. With suitable characteristics explain the jump resonance phenomena. (K2, PO1, PO2)
3. Differentiate between linear and nonlinear systems referred to:
 - i) frequency response, ii) sustained oscillations. (K2, PO1, PO2)
4. Identify and explain the type of singular points for the following two systems:

$$\text{i) } \dot{X} = \begin{bmatrix} 0 & 1 \\ -2 & 3 \end{bmatrix} X \quad \text{and} \quad \text{ii) } \dot{X} = \begin{bmatrix} 0 & 1 \\ -1 & -2 \end{bmatrix} X \quad (\text{K3, PO1, PO2})$$

Course Outcome 5 (CO5):

1. Problems related to the derivation of describing function of a common nonlinearity. (K2, PO1, PO2)
2. Problems related to application of describing function for analysing the stability of given closed loop system. (K3, PO1, PO2, PO3)
3. Obtain the phase trajectory of the system with $\ddot{y} + 6\dot{y} + 5y = 0$, for initial point $x(0)^T = [1 \ 0.6]$. Use Isocline method. Also, identify the type of singular point. (K3, PO1, PO2, PO3)

Course Outcome 6 (CO6):

1. Use Lyapunov Direct method to determine the value of K such that the given LTI system is stable.

$$\dot{X} = \begin{bmatrix} 0 & K \\ -2 & -1 \end{bmatrix} X \quad . \quad (\text{K3, PO1, PO2, PO3})$$

$$\dot{X} = \begin{bmatrix} 0 & 1 & 0 \\ 0 & 0 & 1 \\ -1 & -2 & -5 \end{bmatrix} X$$

2. Determine the stability of the LTI system with state model:
(K3, PO1, PO2, PO3)
3. Test stability of the nonlinear system given below, using Lyapunov method.

$$\dot{X} = \begin{bmatrix} -4 & 0 \\ 3x_2^2 & -2 \end{bmatrix} X \quad (\text{K3, PO1, PO2, PO3})$$

Estd.



2014

Model Question Paper

PAGES: 3

QP CODE:

Reg.No: _____

Name: _____

APJ ABDULKALAM TECHNOLOGICAL UNIVERSITY
SEVENTH SEMESTER B.TECH DEGREE EXAMINATION
MONTH & YEAR

Course Code: EET401

Course Name: **ADVANCED CONTROL SYSTEMS****Max. Marks: 100****Duration: 3 Hours****PART A****Answer all Questions. Each question carries 3 Marks**

1 Selecting $i_1(t) = x_1(t)$ and $i_2(t) = x_2(t)$ as state variables obtain state equation and output equation of the network shown.

2 Obtain the diagonal canonical representation for the system with the transfer function:

$$T(s) = \frac{s + 2}{s^2 + 0.7s + 0.1}$$

3 Determine the transfer function for the system with state model:

$$\dot{X} = \begin{bmatrix} -2 & 1 \\ 0 & -2 \end{bmatrix} x + \begin{bmatrix} 2 \\ 0 \end{bmatrix} u; \quad y = [1 \quad 0]x$$

4 Explain any four properties of state transition matrix.

5 Determine the controllability of the following state model:

$$\dot{x} = \begin{bmatrix} 1 & 0 & 0 \\ 0 & 2 & 1 \\ 0 & -1 & -5 \end{bmatrix} x + \begin{bmatrix} 0 \\ 0 \\ 1 \end{bmatrix} u$$

6 Explain the significance of PBH test for observability.

7 With suitable characteristics explain the jump resonance phenomena in nonlinear systems.

8 Obtain the describing function of deadzone non-linearity.

9 Determine given quadratic form is positive definite or not:

$$V(x) = 10x_1^2 + 4x_2^2 + x_3^2 + 2x_1x_2 - 2x_2x_3 - 4x_1x_3$$

10 Use Lyapunov theorem to determine test stability of the nonlinear system given below.

$$\dot{X} = \begin{bmatrix} -4 & 0 \\ 3x_2^2 & -2 \end{bmatrix} X$$

PART B**Answer any one full question from each module. Each question carries 14 Marks****Module 1**

11 a) Obtain the phase variable representation for the system with transfer function:

$$T(s) = \frac{2s^2 - 3}{s^3 + 6s^2 + 11s + 6}$$

(7 Marks)

b) Derive the state model of an armature controlled DC servo motor.

(7 Marks)

12 a) Determine the diagonal canonical representation for the system:

$$\dot{X} = \begin{bmatrix} -2 & 1 \\ -3 & -2 \end{bmatrix} x + \begin{bmatrix} 1 \\ 0 \end{bmatrix} u; \quad y = [1 \quad -1]x \quad (9 \text{ Marks})$$

- b) Explain any four advantages of state model as compared to transfer function model. (5 Marks)

Module 2

- 13 a) Obtain the unit step response $y(t)$ of the system

$$\dot{X} = \begin{bmatrix} -1 & 0 \\ -2 & -3 \end{bmatrix} x + \begin{bmatrix} 1 \\ 1 \end{bmatrix} u, \quad y = [1 \quad 1]x \quad (10 \text{ Marks})$$

- b) Show that eigen values of state models are unique. (4 Marks)

- 14 a) Determine the state transition matrix for the system with state model:

$$\dot{X} = \begin{bmatrix} -1 & 1 \\ 1 & -2 \end{bmatrix} x \quad (7 \text{ Marks})$$

- b) How do you derive the z transfer function from the state model of a sampled data system? (7 Marks)

Module 3

- 15 a) Consider a linear system described by the transfer function $\frac{Y(s)}{U(s)} = \frac{10}{s(s+1)(s+2)}$. Design a feedback controller with a state feedback so that the closed loop poles are placed at $-2, -1 \pm j1$. (10 Marks)

- b) Write short note on reduced order observer. (4 Marks)

- 16 a) $\dot{x} = \begin{bmatrix} 1 & 2 & 0 \\ 3 & -1 & 1 \\ 0 & 2 & -5 \end{bmatrix} x + \begin{bmatrix} 2 \\ 1 \\ 1 \end{bmatrix} u$

Consider a linear system described by

Design a state observer so that the closed loop poles are placed at $-4, -3 \pm j1$. (9 Marks)

- b) With suitable example explain the concept of duality referred to controllability. (5 Marks)

Module 4

- 17 a) Determine the value of K for an occurrence of limit cycle. Also determine the amplitude, frequency and stability of limit cycle. (10 Marks)

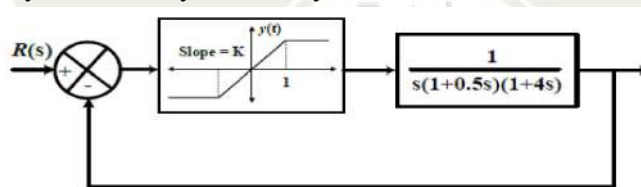

- b) With relevant characteristics explain any three nonlinearities in electrical systems. (4 Marks)

- 18 a) Obtain the describing function of relay with dead zone nonlinearity. (8 Marks)
 b) Explain the linearization concept and assumptions made referred to Describing Function analysis. (6 Marks)

Module 5

- 19 a) A linear second order system is described by the equation: $\ddot{e} + 2\delta\omega ne' + \omega n^2 e = 0$, with $\delta = 0.25$, $\omega n = 1 \text{ rad/sec}$, $e(0) = 1.0$, and $e'(0) = 0$. Determine the singular point and state the stability by constructing the phase trajectory using the method of isoclines. (11 Marks)
 b) Identify and explain the type of singular point for the following system:

$$\dot{X} = \begin{bmatrix} 0 & 1 \\ -2 & 3 \end{bmatrix} X$$

(3 Marks)

- 20 a) Differentiate between stable and unstable limit cycles. (5 Marks)
- b) Use Lyapunov Direct method to determine the value of K such that the given LTI system is stable.

$$\dot{X} = \begin{bmatrix} 0 & K \\ -2 & -1 \end{bmatrix} X$$

(9 Marks)

Syllabus

Module 1

State Space Representation of Systems (7 hours)

Introduction to state space and state model concepts- State equation of linear continuous time systems, matrix representation- features- Examples of electrical circuits and dc servomotors. Phase variable forms of state representation- Diagonal Canonical forms- Similarity transformations to diagonal canonical form.

Module 2

State Space Analysis (9 hours)

State transition matrix- Properties of state transition matrix- Computation of state transition matrix using Laplace transform and Cayley Hamilton method.

Derivation of transfer functions from state equations.

Solution of time invariant systems: Solution of time response of autonomous systems and forced systems.

State space analysis of Discrete Time control systems: Phase variable form and Diagonal canonical form representations- Pulse transfer function from state matrix- Computation of State Transition Matrix (problems from 2nd order systems only).

Module 3

State Feedback Controller Design (6 hours)

Controllability & observability: Kalman's, Gilbert's and PBH tests.- Duality principle

State feedback controller design: State feed-back design via pole placement technique

State observers for LTI systems- types- Design of full order observer.

Module 4

Nonlinear Systems (7 hours)

Types and characteristics of nonlinear systems- Jump resonance, Limit cycles and Frequency entrainment

Describing function method: Analysis through harmonic linearization- Determination of describing function of nonlinearities.

Application of describing function for stability analysis of autonomous system with single nonlinearity (relay, dead zone and saturation only).

Module 5

Phase Plane and Lyapunov Stability Analysis (8 hours)

Phase plots: Concepts- Singular points – Classification of singular points.

Definition of stability- asymptotic stability and instability.

Construction of phase trajectories using Isocline method for linear and nonlinear systems.

Lyapunov stability analysis: Lyapunov function- Lyapunov methods to stability of nonlinear systems- Lyapunov methods to LTI continuous time systems.

Text Books:

1. Nagarath I. J. and Gopal M., Control System Engineering, 5/e, New Age Publishers, 2007
2. Ogata K., Modern Control Engineering, 5/e, Prentice Hall of India, 2010.
3. Gopal M, Modern Control System Theory, 2/e, New Age Publishers, 1984
4. Kuo B.C, Analysis and Synthesis of Sampled Data Systems, Prentice Hall Publications, 2012.

References:

1. Khalil H. K, Nonlinear Systems, 3/e, Prentice Hall, 2002
2. Gibson J.E. Nonlinear Automatic Control, Mc Graw Hill, 1963.
3. Gopal M., Control Systems Principles and Design, 4/e, Tata McGraw Hill, 2012.
4. Slotine J. E and Weiping Li, Applied Nonlinear Control, Prentice-Hall, 1991,
5. Gopal M, Digital Control and State Variable Methods, 2/e, Tata McGraw Hill, 2003
6. Thomas Kailath, Linear Systems, Prentice-Hall, 1980.
7. Ogata K., Discrete Time Control Systems, 2/e, Pearson Education, Asia, 2015

Course Contents and Lecture Schedule:

No	Topic	No. of Lectures
1	State Space Representation of Systems	(7 hours)
1.1	Introduction to state space and state model concepts- state equation of linear continuous time systems, matrix representation- features -Examples of electrical circuits and dc servomotors	3
1.2	Phase variable forms of state representation- features- controllable and observable companion forms	2
1.3	Diagonal canonical forms of state representation- Diagonal & Jordan forms- features- Similarity transformations to diagonal canonical form	2
2	State Space Analysis	(9 hours)
2.1	State transition matrix- Properties of state transition matrix- Computation of state transition matrix using Laplace transform- Cayley Hamilton method.	2
2.2	Derivation of transfer functions from state equations.	1
2.3	Solution of time invariant systems: Solution of time response of autonomous systems and forced systems	3
2.4	State space analysis of Discrete Time control systems: Phase variable form and Diagonal canonical form representations	2
2.5	Pulse transfer function from state matrix- Computation of State Transition Matrix- (problems from 2 nd order systems only)	1
3	State Feedback Controller Design	(6 hours)
3.1	Controllability & observability: Kalman's, Gilbert's and PBH tests- Duality property	2
3.2	State feedback controller design: State feed-back design via pole placement technique	2

3.3	State observers for LTI systems- Full order and reduced order observers- Design of full order observer design	2
4	Nonlinear Systems	(7 hours)
4.1	Types of nonlinear systems- characteristics of nonlinear systems- peculiar features like Jump resonance, Limit cycles and Frequency entrainment	2
4.2	Describing function Method: Analysis through harmonic linearisation	1
4.3	Determination of describing function of nonlinearities	2
4.4	Application of describing function for stability analysis of autonomous system with single nonlinearity (relay, dead zone and saturation only).	2
5	Phase Plane and Lyapunov Stability Analysis	(8 hours)
5.1	Phase plots: Concepts- Singular points - Classification of singular points.	1
5.2	Construction of phase trajectories using Isocline method for linear and nonlinear systems	2
5.3	Definition of stability- asymptotic stability and instability	1
5.4	Lyapunov stability analysis: Lyapunov function- Lyapunov methods to stability of nonlinear systems	2
5.5	Lyapunov methods to LTI continuous time systems.	2

----- x -----

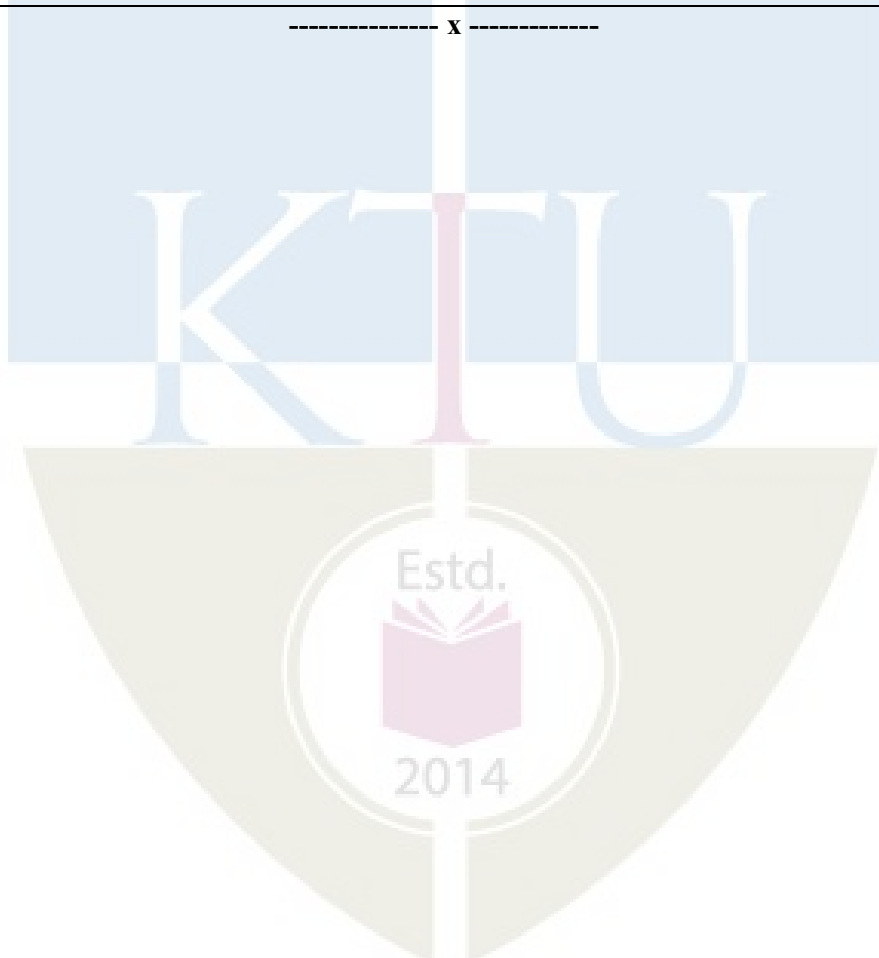

EET413	ELECTRIC DRIVES	CATEGORY	L	T	P	CREDIT
		PEC	2	1	0	3

Preamble: To impart knowledge about the DC and AC motor drives and its applications

Prerequisite: EET306 Power Electronics, EET202 DC Machines and Transformers and EET307 Synchronous and Induction Machines.

Course Outcomes: After the completion of the course the student will be able to

CO 1	Describe the transient and steady state aspects electric drives
CO 2	Apply the appropriate configuration of controlled rectifiers for the speed control of DC motors
CO 3	Analyse the operation of chopper-fed DC motor drive in various quadrants
CO 4	Illustrate the various speed control techniques of induction motors
CO 5	Examine the vector control of induction motor drives
CO 6	Distinguish different speed control methods of synchronous motor drives

Mapping of course outcomes with program outcomes

	PO 1	PO 2	PO 3	PO 4	PO 5	PO 6	PO 7	PO 8	PO 9	PO 10	PO 11	PO 12
CO 1	3	2	-	-	-	-	-	-	-	-	-	-
CO 2	3	2	-	2	-	-	-	-	-	-	-	1
CO 3	3	2	-	2	-	-	-	-	-	-	-	1
CO 4	3	2	-	2	-	-	-	-	-	-	-	1
CO 5	3	1	-	2	-	-	-	-	-	-	-	1
CO 6	3	2	-	2	-	-	-	-	-	-	-	1

Assessment Pattern

Bloom's Category	Continuous Assessment Tests		End Semester Examination
	1	2	
Remember (K1)	10	10	20
Understand (K2)	20	20	40
Apply (K3)	20	20	40
Analyse (K4)			
Evaluate (K5)			
Create (K6)			

Mark distribution

Total Marks	CIE	ESE	ESE Duration
150	50	100	3 hours

Continuous Internal Evaluation Pattern:

Attendance	: 10 marks
Continuous Assessment Test (2 numbers)	: 25 marks
Assignment/Quiz/Course project	: 15 marks

End Semester Examination Pattern: There will be two parts; Part A and Part B. Part A contain 10 questions with 2 questions from each module, having 3 marks for each question. Students should answer all questions. Part B contains 2 questions from each module of which student should answer any one. Each question can have maximum 2 sub-divisions and carry 14 marks.

Course Level Assessment Questions**Course Outcome 1 (CO1):**

1. Derive the condition for steady state stability (K3,K4, PO1, PO4).
2. Draw the speed torque characteristics of traction drive (K1, PO1).
3. Problems based on fundamental torque equations and equivalent values of drive parameters (K3, K4 , PO2, PO4).

Course Outcome 2 (CO2)

1. Numerical problems based on rectifier controlled separately excited dc motor. (K3, K4, PO2, PO4).
2. Describe the function of a three phase inverter driving a dc motor (K2, PO1).
3. Draw the circuit diagram of dual converter and explain the operation (K1, PO1).

Course Outcome 3(CO3):

1. Explain Motoring and braking operation of chopper controlled DC motor (K2,PO1).
2. Numerical problems based on chopper controlled separately excited dc motor. (K3, K4, PO2, PO4).
3. With the block diagram illustrate the closed loop control of SEDC motor (K2, PO4).

Course Outcome 4 (CO4):

1. List different speed control methods for three phase induction motors (K1, PO1)

2. Discuss sine triangle PWM control of three phase induction motor drive (K2, PO4).
3. Numerical problems based on speed control of induction motor drives (K3,K4, PO2, PO4).

Course Outcome 5 (CO5):

1. Draw the block diagram of direct vector control of induction motor drives (K2, PO1).
2. Figure out the differences of scalar and vector control methods of three phase induction motor (K3, PO1).
3. Draw the decoupled diagram and phasor diagram of three phase induction motor (K2, PO1).

Course Outcome 6 (CO6):

1. Explain v/f control of three phase synchronous motor drive (K2, PO1).
2. Enumerate different speed control methods of synchronous motor drives (K1, PO1).
3. With the diagram of load commutated CSI synchronous motor drive discuss the operation (K2, PO1).

Model Question Paper

PAGES: 3

QPCODE:

Reg. No: _____

Name: _____

**APJ ABDUL KALAM TECHNOLOGICAL UNIVERSITY
SEVENTH SEMESTER B. TECH DEGREE EXAMINATION
MONTH & YEAR**

Course Code: **EET413**Course Name: **ELECTRIC DRIVES****Max. Marks: 100****Duration: 3 Hours****PART A****Answer all Questions.****Each question carries 3 Marks**

- 1 Draw the block diagram of an electric drive.
- 2 List 3 classifications of load torque with one example for each.
- 3 For a single phase fully-controlled rectifier fed separately excited DC motor, the armature current is assumed to be continuous and ripple free ($i_a = I_a$). Draw the source current waveform for a firing angle of 45° .

- 4 Can a half-controlled rectifier fed separately excited DC drive operated in quadrant IV? Justify your answer.
- 5 Draw the circuit diagram of a two-quadrant (class C) chopper showing the two quadrants of operation.
- 6 With the help of the torque – speed characteristics of a DC series motor, explain why it is used for high-starting torque applications?
- 7 Constant torque loads are not suitable for AC voltage controller fed induction motor drive. Why?
- 8 Why V/f ratio is kept constant upto base speed and V constant above base speed in variable frequency control of an induction motor?
- 9 Differentiate between true synchronous mode and self-control mode of operation of a synchronous motor.
- 10 List any two advantages of vector control of 3-phase induction motors.

PART B

Answer any one full question from each module.

Each question carries 14 Marks

Module 1

- 11 a) What are the advantages of electric drives? (7)
 b) Explain the multi-quadrant operation of a motor driving a hoist load. (7)
- 12 a) Explain about steady state stability of equilibrium point in electric drive. (7)
 b) A drive has following parameters: - $J=10\text{kg-m}^2$, $T=100-0.1N$ and $T_l=0.05N$ where N is the speed in rpm. Initially the drive is operating in steady state. Now it is to be reversed. For this motor characteristics is changed to $T = -100-0.1N$. Calculate the time of reversal. (7)

Module 2

- 13 a) Explain the working of 3-phase fully-controlled separately excited DC drive with necessary waveforms. (7)
 b) A 220V, 1500rpm, 10A separately excited DC motor is fed from a single phase fully controlled rectifier with an ac source voltage of 230V, 50Hz. $R_a=2\Omega$. Conduction can be assumed to be continuous. Calculate the firing angles for rated motor torque and -1000rpm. (7)
- 14 a) Explain the discontinuous conduction mode of operation of a fully controlled rectifier fed separately excited DC motor with necessary waveforms. (7)
 b) Explain the working of a dual converter (circulating current type) fed separately excited DC motor. (7)

Module 3

- 15 a) Explain the operation of four quadrant chopper fed DC drives. (7)
 b) A chopper used to control the speed of a separately excited DC motor has supply voltage of 230V, $T_{on} = 15\text{ms}$, $T_{off} = 5\text{ms}$. Assuming continuous conduction of motor current, calculate the average load current when the motor speed is 3000rpm. Assume voltage constant $K_v = 0.5\text{V/rad/sec}$ and $R_a = 4\Omega$. (7)

- 16 a) Explain the chopper control of DC series motor. (7)
 b) Using a neat block diagram, explain the closed loop speed control for a separately excited DC motor. (7)

Module 4

- 17 a) Explain V/f control of 3-phase induction motor using necessary speed – torque characteristics. (7)
 b) A 440V, 3-phase, 50Hz, 6-pole, 945rpm, delta connected induction motor has following parameters referred to the stator: $R_s = 2\Omega$, $R_r' = 2\Omega$, $X_s = 3\Omega$, $X_r' = 4\Omega$. When driving a fan load at rated voltage it runs at rated speed. The motor speed is controlled by stator voltage control. Determine motor terminal voltage, current and torque at 800rpm. (7)
- 18 a) Explain the working of static rotor resistance control of 3-phase induction motor. Also derive the expression for the total rotor circuit resistance per phase. (7)
 b) Explain the static slip power recovery scheme using one uncontrolled bridge rectifier and one controlled bridge rectifier in the rotor circuit. (7)

Module 5

- 19 a) Describe the principle of operation of vector control. (7)
 b) Explain the variable frequency control of multiple synchronous motor. (7)
- 20 a) Explain Clerke and Park transformation with necessary equations. (5)
 b) Describe the working of a self-controlled synchronous motor drive employing load commutated thyristor inverter. (9)

Syllabus (36 hours)

Module 1 (6 hours)

Introduction to electric drives – block diagram – advantages of electric drives – dynamics of motor load system, fundamental torque equations, types of load – classification of load torque, four quadrant operation of drives, Equivalent values of drive parameters- effect of gearing - steady state stability.

Module 2 (7 hours)

Rectifier control of DC drives- separately excited DC motor drives using controlled rectifiers- single-phase fully controlled rectifier fed drives (discontinuous and continuous mode of operation), critical speed - single-phase semi converter fed drives (continuous mode of operation) - three-phase semi converter and fully controlled converter fed drives (continuous mode of operation) - dual converter control of DC motor - circulating current mode.

Module 3 (6 hours)

Chopper control of DC drives - two quadrant and four quadrant chopper drives - motoring and regenerative braking - chopper fed DC series motor drive - closed loop speed control for separately excited dc motor.

Module 4 (10 hours)

Three phase induction motor drives: Stator voltage control - Stator frequency control – v/f control - below and above base speed – Voltage Source Inverter (VSI) fed v/f control using sine-triangle PWM - static rotor resistance speed control employing chopper – static slip power recovery speed control scheme for speed control below synchronous speed.

Module 5 (7 hours)

Concept of space vector – Clarke and Park transformation – field orientation principle – Introduction to direct vector control of induction motor drives – decoupling of flux and torque components - space vector diagram and block diagram [Ref.1].

Synchronous motor drives – v/f control – open loop control – self-controlled mode – load commutated CSI fed synchronous motor.

Note: Simulation assignments can be given using modern simulation tools like MATLAB, PSIM, PSpice, LTspice etc. from all modules of 2, 3, 4 and 5.

Text Books

1.G. K. Dubey, “Fundamentals of Electric Drives”, Narosa publishers, second edition, 2001

Reference Books.

1. Bimal K.Bose, “Power Electronics and and Motor Drives”, Academic press, An Imprint of Elsevier, 2006.
2. Vedam Subrahmanyam, “Electric Drives Concepts and Applications”, MC Graw Hill Education, second edition, 2011,New Delhi.
3. Dr. P. S. Bimbhra, “Power Electronics”, Khanna publishers, fifth edition, 2012.
4. Ned Mohan, Tore M Undeland, William P Robbins, “Power electronics converters applications and design”, John Wiley and Sons Inc.,3rd edition
5. Muhammad H.Rashid, “Power Electronics, Devices, Circuits and Applications”, Pearson, 3rd edition, 2014
6. R Krishnan, “Electric Motor Drives: Modeling, Analysis, and Control”, Prentice Hall, 2001.

Course Contents and Lecture Schedule

No	Topic	No. of Lectures
1	Fundamentals of Electric drives (6 hours)	
1.1	Introduction to electric drives- block diagram – advantages of electric drives	1
1.2	Dynamics of motor load system, fundamental torque equations,	1
1.3	four quadrant operation of drives	1
1.4	Types of load – classification of load torque	1
1.5	Equivalent values of drive parameters- effect of gearing -	1
1.6	Steady state stability	1
2	Rectifier Control of DC drives (7 hours)	
2.1	Rectifier controlled DC drives- separately excited DC motor drives using controlled rectifiers- single-phase fully controlled rectifier fed drives discontinuous mode of operation,	2
2.2	continuous mode of operation - critical speed	1
2.3	single-phase semi converter fed drives (continuous mode of operation)	1
2.4	three-phase semi converter controlled converter fed drives (continuous mode of operation)	1
2.5	Three phase fully controlled converter fed drives (continuous mode of operation)	1
2.6	Dual converter control of DC motor - circulating current mode	1
3	Chopper control of DC drives (6 hours)	
3.1	Two quadrant chopper DC drives - motoring and regenerative braking	2
3.2	Four quadrant chopper DC drives	1
3.3	Chopper fed DC series motor drive	2
3.4	Closed loop speed control for separately excited dc motor.	1
4	Three phase induction motor drives (10 hours)	
4.1	Stator voltage control - Stator frequency control	1
4.2	v/f control - below and above base speed	2
4.3	Voltage Source Inverter (VSI) fed v/f control using sine-triangle PWM	2
4.4	Static rotor resistance speed control employing chopper	1
4.5	Static slip power recovery speed control scheme for speed control below synchronous speed.	1
4.6	Auto Sequential Commutated Current source Inverter (CSI) fed induction motor drives	1
4.7	Current regulated VSI using power semiconductor devices, operation and control scheme - comparison of CSI and VSI fed	2

	drives.	
5	Concept of space vector , Synchronous motor drives (7 hours)	
5.1	Concept of space vector – Clarke and Park transformation – field orientation principle – Introduction to direct vector control of induction motor drives – decoupling of flux and torque components - space vector diagram and block diagram.	4
5.2	Synchronous motor drives – v/f control – open loop control	1
5.3	Self-controlled mode – load commutated CSI fed synchronous motor.	2

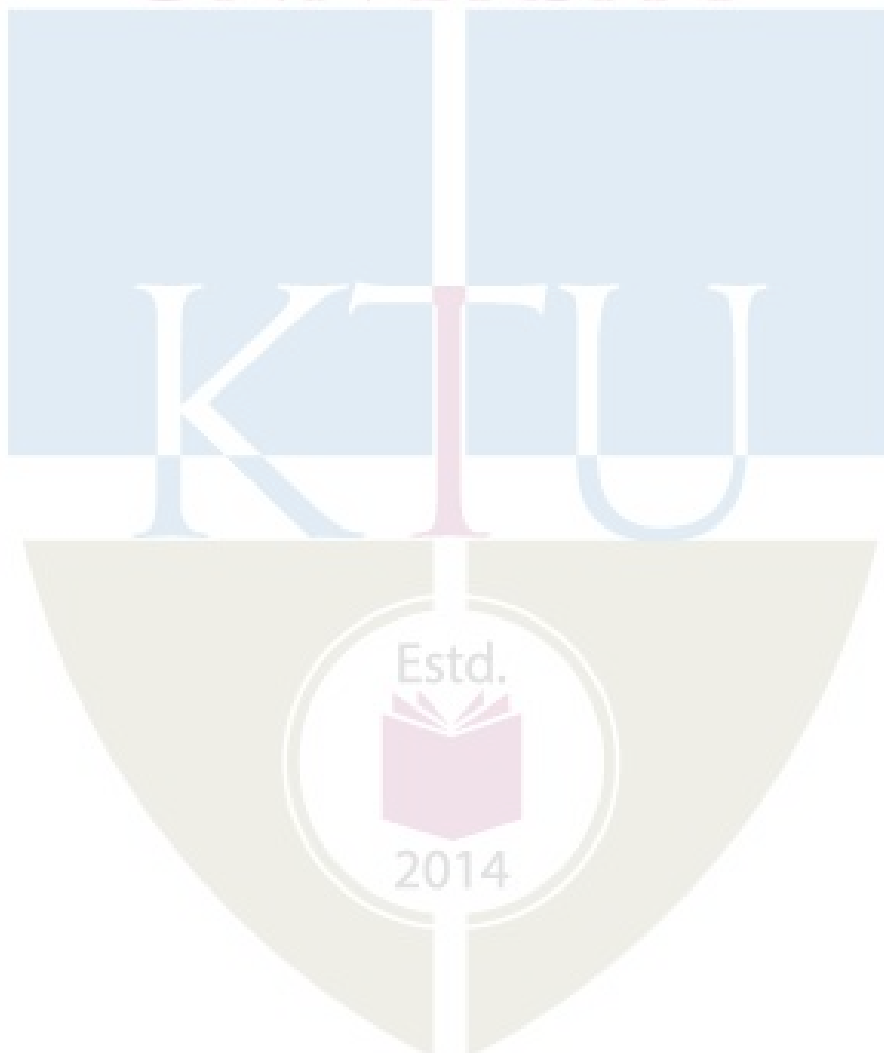

CODE	COURSE NAME	CATEGORY	L	T	P	CREDIT
EET423	DIGITAL CONTROL SYSTEMS	PEC	2	1	0	3

Preamble: This course aims to provide a strong foundation in discrete domain modelling, analysis and design of digital controllers to meet performance requirements.

Prerequisite: EET201 Circuits and Networks, EET305 Signals and Systems, and EET302 Linear Control Systems

Course Outcomes : After the completion of the course the student will be able to:

CO 1	Describe the various control blocks and components of digital control systems.
CO 2	Analyse sampled data systems in z-domain.
CO 3	Design a digital controller/ compensator in frequency domain.
CO 4	Design a digital controller/ compensator in time domain.
CO 5	Apply state variable concepts to design controller for linear discrete time system.

Mapping of course outcomes with program outcomes

	PO 1	PO 2	PO 3	PO 4	PO 5	PO 6	PO 7	PO 8	PO 9	PO 10	PO 11	PO 12
CO 1	3	3	3	-	-	-	-	-	-	-	-	2
CO 2	3	3	3	3	-	-	-	-	-	-	-	2
CO 3	3	3	3	3	2	-	-	-	-	-	-	3
CO 4	3	3	3	3	2	-	-	-	-	-	-	3
CO 5	3	3	3	3	-	-	-	-	-	-	-	3

Assessment Pattern:

Total Marks	CIE marks	ESE marks	ESE Duration
150	50	100	03 Hrs

Bloom's Category	Continuous Assessment Tests		End Semester Examination
	1	2	
Remember (K1)	10	10	10
Understand (K2)	15	15	30
Apply (K3)	25	25	50
Analyse (K4)			
Evaluate (K5)			
Create (K6)			

End Semester Examination Pattern : There will be two parts; Part A and Part B. **Part A** contains 10 questions with 2 questions from each module, having 3 marks for each question. Students should answer all questions.

Part B contains 2 questions from each module of which student should answer any one. Each question carries 14 marks and can have maximum 2 sub-divisions.

Course Level Assessment Questions:**Course Outcome 1 (CO1)**

1. Selection of sampling period and elements of discrete time systems (K2) (PO1, PO2).
2. Derivation of the transfer functions of discrete time systems (K3)(PO1, PO2, PO3, PO12).
3. Relations between continuous system poles and that in discrete domain (K2) (PO1, PO2).

Course Outcome 2 (CO2):

1. Derivation of pulse transfer function or response function of various system configurations (K3) (PO1, PO2, PO3, PO4, PO12).
2. Determination of time response of systems, error constant and steady state error (K2) (PO1, PO2).
3. Problems to analyse the response of systems (K3) (PO1, PO2, PO3, PO4, PO12).

Course Outcome 3(CO3):

1. Obtain the frequency response and design controller (K3) (PO1, PO2, PO3, PO4, PO5, PO12).
2. Design suitable compensator in frequency domain (K3) (PO1, PO2, PO3, PO4, PO5, PO12).
3. Problems related to compensator and controller design in frequency domain (K3) (PO1, PO2, PO3, PO4, PO5, PO12).

Course Outcome 4 (CO4):

1. Problems related to design controller from time response (K3) (PO1, PO2, PO3, PO4, PO5, PO12).
2. Design suitable compensator in time domain (K3) (PO1, PO2, PO3, PO4, PO5, PO12).
3. Problems related compensator and controller design in time domain (K3) (PO1, PO2, PO3, PO4, PO5, PO12).

Course Outcome 5 (CO5):

1. Problems related to modelling and analysis (stability, controllability and observability) of system in state space (K2) (PO1, PO2, PO3, PO4).
2. Design a state feedback controller and observer (K3) (PO1, PO2, PO3, PO4).
3. Problems to identify the response and solution of state equation (K2) (PO1, PO2, PO3, PO4).

Model Question Paper

PAGES: 2

QP CODE:

Reg.No: _____

Name: _____

**APJ ABDUL KALAM TECHNOLOGICAL UNIVERSITY
SEVENTH SEMESTER B.TECH DEGREE EXAMINATION
MONTH & YEAR**

Course Code: **EET423**Course Name: **DIGITAL CONTROL SYSTEMS****Max. Marks: 100****Duration: 3 Hours****PART A****Answer all Questions. Each question carries 3 Marks**

- 1 Explain any four advantages of sampled data control systems.
- 2 Identify and justify a suitable sampling frequency for the continuous time system with transfer function $G(s) = \frac{100}{(s+1)(s+10)(s+100)}$

- 3 Obtain the pulse transfer function for the given system.

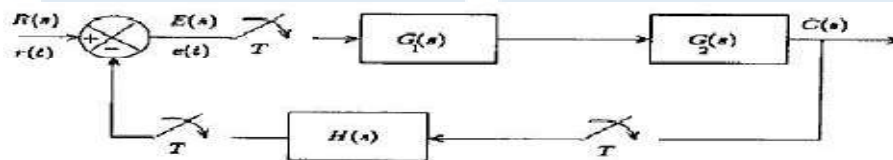

- 4 Distinguish between type and order of a system.
- 5 Explain the frequency domain specifications.
- 6 Realize the digital compensator with transfer function $D(z) = \frac{2.3798z-1.9387}{z-0.5589}$
- 7 Draw and explain the mapping between s- plane to z-plane for the constant frequency loci.
- 8 What is dead beat response?
- 9 Identify the discrete equivalent of the continuous time system $\dot{x} = Ax$ when the sampling period is T_s
- 10 Define controllability and observability.

PART B**Answer any one full question from each module. Each question carries 14 Marks****Module 1**

- 11 a) Derive the transfer function of a FoH circuit. (6)
- b) Determine the pulse transfer function of the system with transfer function $H(s) = \frac{3}{s(s+2)^2}$ if the sampling period is 0.1s. (8)
- 12 a) Derive the transfer function of a ZoH circuit. (5)
- b) Realize the digital filter $D(z) = \frac{2z-0.6}{z+0.5}$ by the three methods of direct, standard and ladder programming. (9)

Module 2

- 13 Obtain the pulse transfer function for the unity feedback system with $G_1(s) = \frac{1}{s}$, $G_2(s) = \frac{1}{(s+2)}$ and assume $T=0.1s$ and hence determine the step response of the system.

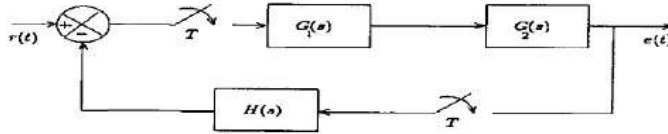

- (14)
14 a) Obtain the unit impulse response $C(n)$ of the following feedback DT system with $G(s) = \frac{1}{(s+3)}$, $H(s) = \frac{1}{s}$,

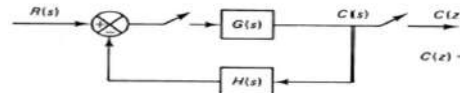

- Assume ideal sampling and $T=1$ ms. (9)
b) Explain the factors on which the steady state error constants depend on? (5)

Module 3

- 15 Design a suitable compensator for the unity feedback system with forward transfer function $G(z) = \frac{0.01758(z+0.8753)}{(z-1)(z-0.6703)}$, $T = 0.1s$, such that the phase margin of the system be atleast 45° at approximately 2 rad/sec and velocity error constant atleast $100s^{-1}$. (14)

- 16 Consider the unity feedback system with forward transfer function

$$G(z) = \frac{K(0.01873z + 0.01752)}{z^2 - 1.8187z + 0.8187}$$

Design a controller for the system such that the w -plane phase margin is 50° , gain margin is 10dB, and the static velocity error constant is 2 sec^{-1} . Assume a sampling period of 0.2sec.

(14)

Module 4

- 17 Design a suitable digital compensator for the unity feedback system with open loop transfer function $G(s) = \frac{1}{s(s+4)}$ to meet the following specifications. Velocity error constant $K_v \geq 40 \text{ sec}^{-1}$, Damping factor $\zeta = 0.5$, Natural frequency $\omega_n = 4 \text{ rad/sec}$.

Assume a sampling period of 0.1s (14)

- 18 Design a controller, by the method of Ragazzini, for the unity feedback system with open loop transfer function $G(z) = \frac{0.018201(z+0.905)}{(z-1.105)(z-0.6703)}$, $T = 0.1s$ to meet the following specifications. Damping factor $\zeta = 0.5$, Natural frequency $\omega_n = 2 \text{ rad/sec}$ and zero steady state error for unit step input. (14)

Module 5

- 19 Design a suitable controller for the system by selecting suitable poles. $x(k+1) = \begin{bmatrix} 0.9128 & -0.008826 & 0.1574 \\ 0.09194 & 1.114 & -0.1662 \\ 0.07429 & -0.08753 & 0.6855 \end{bmatrix} x(k) + \begin{bmatrix} 0.104 \\ -0.00411 \\ 0.08707 \end{bmatrix} u(k)$, $y(k) = [0 \ 1 \ 0]x(k)$ Formulate the control law that can perfectly track a step command. Since the output is directly available for measurement. design a reduced

order observer to realise the controller.

(14)

- 20 Compute the unit step response of the system represented by $x(k+1) = \begin{bmatrix} 0.9048 & 0 \\ 0.08611 & 0.8187 \end{bmatrix} x(k) + \begin{bmatrix} 0.09516 \\ 0.09516 \end{bmatrix} u(k)$, $y(k) = [1 \ 1]x(k)$ assume the initial state $x(0) = \begin{bmatrix} 1 \\ 2 \end{bmatrix}$.

(14)

Syllabus

Module 1

Basics of Digital Control (6 hours)

Basic digital control system- Mathematical modelling - sampling and reconstruction - Zero order and First order hold circuits - realisation of digital filters. Relation between transfer function and pulse transfer function - Mapping between s-domain and z-domain.

Module 2

Response Computation (7 hours)

Pulse transfer function of different configurations of systems- Modified z-transform- Time Response of discrete time system. Order and Type of a system Steady state error and Static error constants.

Module 3

Design of controller/Compensator in frequency domain (7 hours)

Bilinear transformation and sketching of frequency response - Digital P/PI/PID controller design based on frequency response - Digital compensator based on frequency response. Introduction to design and simulation using MATLAB (for demo/ assignment only and not to be included for examination).

Module 4

Design of controller/Compensator based on time response (7 hours)

Design of lag, lead and lag-lead compensator using root locus - Design of controllers and compensators by the method of Ragazzini- Dead beat response and deadbeat controller design.

Module 5

Modern control approach to digital control (10 hours)

Introduction to state space - state space modelling of discrete time SISO system - Computation of solution of state equation and state transition matrix. Controllability, observability and stabilizability of discrete time systems- Loss of controllability and observability due to sampling. Digital controller and observer design - state feedback – pole placement - full order observer - reduced order observer.

Text Book:

1. C. L. Philips, H. T. Nagle, Digital Control Systems, Prentice-Hall, Englewood Cliffs, New Jersey, 1995.
2. M. Gopal, Digital Control and State Variable Methods, Tata McGraw-Hill, 1997
3. Ogata K., Discrete-Time Control Systems, Pearson Education, Asia.

References:

1. Benjamin C. Kuo, Digital Control Systems, 2/e, Saunders College Publishing, Philadelphia, 1992.
2. Constantine H. Houppis and Gary B. Lamont, Digital Control Systems Theory, Hardware Software, McGraw Hill Book Company, 1985.
3. Isermann R., Digital Control Systems, Fundamentals, Deterministic Control, V. I, 2/e, Springer Verlag, 1989.
4. Liegh J. R., Applied Digital Control, Rinchart & Winston Inc., New Delhi.
5. Åström, Karl J., and Björn Wittenmark,. Computer-controlled systems: theory and design. Courier Corporation, 2013.

Course Contents and Lecture Schedule

No	Topic	No. of Lectures
1	Basics of Digital Control	(6 hours)
1.1	Basic digital control system- Examples - mathematical model - choice of sampling and reconstruction-ZOH and FOH	2
1.2	Realisation of digital filters.	2
1.3	Relation between s and z - Mapping between s-domain and z-domain	2
2	Response Computation	(7 hours)
2.1	Pulse transfer function- Different configurations for the design	2
2.2	Time Response of discrete time system.	2
2.3	Steady state performance and error constants.	3
3	Design of controller/Compensator in frequency domain	(7 hours)
3.1	Digital P/PD/PI controller design	2
3.2	Digital PID controller design	1
3.3	Design of lag and lead compensator,	2
3.4	Design of lag-lead compensator.	1
3.5	Demo with MATLAB	1
4	Design of controller/Compensator based on time response	(7 hours)
4.1	Design of lag and lead compensator.	2
4.2	Design of lag-lead compensator.	1
4.3	Design based on method of Ragazzini.	2
4.4	Dead beat response design and deadbeat controller design.	2
5	Modern control approach to digital control	(10 hours)
5.1	Introduction to state space-	1
5.2	Computation of solution of state equation and state transition matrix. (examination questions can be limited to second order systems)	2
5.3	Controllability, Observability, and stabilizability of systems	2
5.4	Loss of controllability and observability due to sampling.	1
5.5	State feedback controller based on pole placement.	2
5.6	Observer design based on pole placement.	2

CODE	COURSE NAME	CATEGORY	L	T	P	CREDIT
EET433	MODERN OPERATING SYSTEMS	PEC	2	1	0	3

Preamble: Understanding of concepts of OS, through process/threads, system call interface, inter process communication, deadlock, scheduling, address space, main memory, virtual memory and file systems.

Prerequisite: NIL

Course Outcomes: After the completion of the course the student will be able to:

CO 1	Describe the key concepts of modern operating systems
CO 2	Apply the concepts of scheduling, resource management and process synchronization for process management.
CO 3	Evaluate the implementation of various memory management techniques.
CO 4	Illustrate different file management and directory management methods.
CO 5	Evaluate Disc scheduling algorithms
CO 6	Explain RAID structures

Mapping of course outcomes with program outcomes

	PO 1	PO 2	PO 3	PO 4	PO 5	PO 6	PO 7	PO 8	PO 9	PO 10	PO 11	PO 12
CO 1	2											
CO 2	2	2										2
CO 3	2	2										2
CO 4	2											
CO 5	2	2										

Assessment Pattern

Bloom's Category	Continuous Assessment Tests		End Semester Examination
	1	2	
Remember (K1)	15	15	30
Understand (K2)	20	20	40
Apply (K3)	15	15	30
Analyse (K4)			
Evaluate (K5)	-	-	-
Create (K6)	-	-	-

Mark distribution

Total Marks	CIE	ESE	ESE Duration
150	50	100	3 hours

Continuous Internal Evaluation Pattern:

Attendance	: 10 marks
Continuous Assessment Test (2 numbers)	: 25 marks
Assignment/Quiz/Course project	: 15 marks

End Semester Examination Pattern: There will be two parts; Part A and Part B. Part A contain 10 questions with 2 questions from each module, having 3 marks for each question. Students should answer all questions. Part B contains 2 questions from each module of which student should answer any one. Each question can have a maximum 2 sub-divisions and carry 14 marks.

Course Level Assessment Questions**Course Outcome 1 (CO1):**

1. What is an operating system?(K1, PO1)
2. What are operating system services?(k2, PO1)
3. Explain time sharing operating system?(K1, PO1)
4. Explain OS structure?(K2, PO1, PO2)

Course Outcome 2 (CO2):

1. Define the process? (K1, PO1)
2. What is meant by the state of the process?(K1,PO2)
3. What are the types of schedulers?(K1, PO2)
4. Consider the following five processes, with the length of the CPU burst time given in milliseconds. Process Burst time P1 10 P2 29 P3 3 P4 7 P5 12 Consider the First come First serve (FCFS), Non Pre-emptive Shortest Job First (SJF), Round Robin(RR) (quantum=10ms) scheduling algorithms. Illustrate the scheduling using Gantt charts.(K3, PO1,PO2)
5. Define race condition.(K2, PO2)
6. What are the requirements that a solution to the critical section problem must satisfy?(K2, PO1, PO2)

Course Outcome 3 (CO3):

1. Define Swapping(K1,PO2)
2. What is Demand Paging?(K2,PO1,PO2)

3. Explain about the following page replacement algorithms a)FIFO b)OPR, c)LRU
4. Differentiate local and global page replacement algorithms. Differentiate local and global page replacement algorithm(K3, PO1,PO2)

Course Outcome 4 (CO4):

1. What is a File?(K1, PO1)
2. What are the various File Operations?(K1, PO1)
3. What are the different Accessing Methods of a File?(K2, PO2)
4. What are the Allocation Methods of a Disk Space?(K2, PO2)

Course Outcome 5 (CO5):

1. Explain different Disk scheduling algorithms SCAN,CSCAN.CLOOK(K3, PO1,PO2)
2. Explain disk structure in detail(K2, PO1)
3. What are goals for good disk scheduling algorithm(K1, PO1)
4. Define seek time, Rotational latency and disk bandwidth(K1, PO1)

Course Outcome 6 (CO6):

1. What is RAID Technology(K1, PO1)
2. What data is stored on the second hard drive with RAID 1?(K2,PO2)
3. Explain RAID level 10(K2, PO1, PO2)

Model Question Paper

**APJ ABDUL KALAM TECHNOLOGICAL UNIVERSITY SEVENTH SEMESTER
B.TECH DEGREE EXAMINATION,
MONTH & YEAR**

Course Code: EET433

Course Name:

**Max. Marks: 100
Hours**

Duration: 3

PART A (3 x 10 = 30 Marks)

Answer all Questions. Each question carries 3 Marks

1. Explain the concept of Multiprogramming and Multiprocessing
2. Enlist different kinds of computing environments
3. Compare and contrast user level threads & kernel level threads? Illustrate various multi-threading models.
4. What are the conditions for deadlock?

5. Differentiate between External fragmentation and Internal fragmentation
6. What is thrashing
7. Enlist five file attributes? What you mean by extended file attributes
8. Distinguish between sequential access file & direct access file. Give example on each
9. Define seek time, Rotational latency and disk bandwidth
10. Differentiate between viruses and worms , Give one example for each

PART B (14 x 5 = 70 Marks)

Answer any one full question from each module. Each question carries 14 Marks

Module 1

11. (a) Explain the role of OS as Extended Machine (7)
 (b) Explain User Operating-System Interface in detail (7)
- OR**
12. (a) Differentiate between grid computing & Cloud computing. Give examples for each. (6)
 (b) What are the functions of the process management module of the OS? What is PCB, Explain its structure (8)

Module 2

13. Consider the following five processes, with the length of the CPU burst time given in milliseconds. Process Burst time P1 10 P2 29 P3 3 P4 7 P5 12 Consider the First come First serve (FCFS), Non Preemptive Shortest Job First (SJF), Round Robin(RR) (quantum=10ms) scheduling algorithms. Illustrate the scheduling using Gantt chart. Also find average waiting time and turnaround time for each algorithm (14)
- OR**
14. (a) What is race condition? List the condition to be satisfied to ensure mutual exclusion in critical section (7)
 (b) Explain semaphores. (7)

Module 3

15. (a) What is contiguous memory allocation? (7)
 (b) Explain the different methods and strategies of contiguous memory allocation (7)

OR

16. (a) Explain paging scheme for memory management, discuss the paging hardware and Paging (5)
- (b) Explain about the following page replacement algorithms a) FIFO b) OPR, c) LRU (9)

Module 4

17. (a) What are the operations that can be performed on files (7)
- (b) Explain Indexed file allocation with proper illustration (7)

OR

18. (a) What is meant by directory structure (6)
- (b) What is free space management? Illustrate bit vector free space management technique (8)

Module 5

19. (a) What are goals for good disk scheduling algorithm (4)
- (b) Consider a disk with 300 tracks and the queue has random requests from different processes in the order: 60, 39, 23, 90, 170, 150, 38, 194, 295. Initially the arm is at 100. Find the Average Seek length using FIFO, SSTF, SCAN and C-SCAN algorithms (10)

OR

20. (a) Explain different RAID Level in details with proper illustration (8)
- (b) Explain programme threats and system threats with proper examples (6)

Syllabus

Module 1: Introduction-Definition- Operating System Structure- Operating System Operations, Process Management- Memory Management- Storage Management- Protection and Security- User and Operating-System Interface-System Calls- Types of System Calls Computing Environments- Open-Source Operating Systems.

Process Management- Process Concept- Operations on Processes-Threads Overview- Multithreading Models

Module 2 - CPU Scheduling- Basic Concepts- Scheduling Criteria- Scheduling Algorithms- First come first served scheduling - Shortest job first - Shortest remaining time next- Round robin scheduling - Priority scheduling.

Inter-process communication - race condition - critical sections - Mutual exclusion with busy waiting - sleep and wakeup - Semaphores, Mutexes

Introduction to Deadlocks
Module 3: Memory Management-Swapping- Contiguous Memory Allocation- Virtual memory - Paging - Page tables – TLBs - Page replacement algorithms - Optimal page replacement algorithm - - First-in first-out algorithm - Second chance page replacement algorithm - Clock algorithm - Least recently used algorithm - the working set page replacement algorithm -Belady’s anomaly, local verses global policies
Module 4: File Management- File-System Interface- File Concept- Access Methods - Directory and Disk Structure - File-System Mounting - File Sharing- Protection- File-System Implementation- File-System Structure- - Directory Implementation- Allocation Methods Free-Space Management - Efficiency and Performance
Module 5: Mass Storage Structure- Disk Scheduling- RAID Structure - - Protection and Security- Protection- Goals of Protection- Principles of Protection- Domain of Protection- Access Matrix Implementation of Access Matrix- Access Control- Revocation of Access Rights Security- The Security Problem -Program Threats- System and Network Threats

Text Book

1. Abraham Silberschatz, Greg Gagne, Peter B. Galvin Author, Operating System Concepts, 10th Edition “Title”, Publisher, 9thth edition, Wiley publishers

Reference Books

1. William Stallings “Operating Systems: Internals and Design Principles, 7th edition, prentice Hall
2. Andrew S. Tanenbaum; Modern Operating systems ,4th edition, Person publications

Course Content and Lecture Schedule

No	Topic	No. of Lectures
Module 1 (9 hrs)		
1.1	Introduction-Definition– Operating System Structure	1
1.2	Operating System Operations, Process Management and Memory Management	1
1.3	Storage Management- Protection and Security	1
1.4	User and Operating-System Interface	1
1.5	System Calls, Types of System Calls	1
1.6	Computing Environments- Open-Source Operating Systems	1
1.7	Process Management- Process Concept	1
1.8	Operations on Processes	1

1.9	Threads Overview- Multithreading Models	1
	Module 2 (8 hrs)	
2.1	CPU Scheduling- Basic Concepts- Scheduling Criteria	1
2.2	Scheduling Algorithms- First come first served scheduling- problems	1
2.3	Shortest job first - Shortest remaining time next- problems	1
2.4	Round robin scheduling - Priority scheduling.- problems	1
2.5	Inter-process communication - race condition - critical sections	1
2.6	critical sections and Mutual exclusion with busy waiting	1
2.7	Sleep and wakeup Semaphores, Mutexes	1
2.8	Deadlock- introduction only	1
	Module 3 (7 hrs)	
3.1	Memory Management-Swapping- Contiguous Memory Allocation	1
3.2	Virtual memory – Paging	1
3.3	Page tables – TLBs	1
3.4	Page replacement algorithms- Optimal page replacement algorithm - FIFO	1
3.5	Least recently used algorithm	1
3.6	Second chance page replacement algorithm - Clock algorithm	1
3.7	the working set page replacement algorithm -Beladys anomaly, local verses global policies	1
	Module 4 (7 hrs)	
4.1	File Management- File-System Interface- File Concept- Access Methods	1
4.2	Directory and Disk Structure	1
4.3	File-System Mounting - File Sharing- Protection- F	1
4.4	File-System Implementation- File-System Structure-	1
4.5	Directory Implementation-	1
4.6	Allocation Methods Free-Space Management	1
4.7	Efficiency and Performance	1
	Module 5 (5 hrs)	
5.1	Disk Scheduling-	1
5.2	RAID Structure	1
5.3	Protection- Goals of Protection- Principles of Protection- Domain of Protection	1
5.4	Access Matrix Implementation of Access Matrix- Access Control- Revocation of Access Rights Security-	1
5.5	The Security Problem -Program Threats- System and Network Threats	1

CODE	COURSE NAME	CATEGORY	L	T	P	CREDITS
EET443	DATA STRUCTURES	PEC	2	1	0	3

Preamble: This course aims at moulding the learner to understand the various data structures, their organization and operations. The course helps the learners to assess the applicability of different data structures and associated algorithms for solving real world problems efficiently. This course introduces abstract concepts for data organization and manipulation using data structures such as stacks, queues, linked lists, binary trees and graphs for designing their own data structures to solve practical application problems.

Prerequisite: EST 102 Programming in C

Course Outcomes: After the completion of the course the student will be able to:

CO 1	Analyze the time and space efficiency of the data structure(K3)
CO 2	Describe how arrays, records, linked structures, stacks and queues are used by algorithms (K1)
CO 3	Compare and contrast the benefits of dynamic and static data structures implementations(K3)
CO 4	Explain different memory management techniques and their significance (K3)
CO 5	Develop algorithms incorporating trees and graphs (K3)

Mapping of course outcomes with program outcomes

	PO 1	PO 2	PO 3	PO 4	PO 5	PO 6	PO 7	PO 8	PO 9	PO 10	PO 11	PO 12
CO 1	3	2										
CO 2	3	2										
CO 3	3	2										
CO 4	3	2										
CO 5	3	2										
CO 6	3	2										

Assessment Pattern

Bloom's Category	Continuous Assessment Tests		End Semester Examination
	1	2	
Remember (K1)	10	10	20
Understand (K2)	25	25	50
Apply (K3)	15	15	30
Analyse (K4)	-	-	-
Evaluate (K5)	-	-	-
Create (K6)	-	-	-

Mark distribution

Total Marks	CIE	ESE	ESE Duration
150	50	100	3 hours

Continuous Internal Evaluation Pattern:

Attendance	: 10 marks
Continuous Assessment Test (2 numbers)	: 25 marks
Assignment/Quiz/Course project	: 15 marks

End Semester Examination Pattern: There will be two parts; Part A and Part B. Part A contain 10 questions with 2 questions from each module, having 3 marks for each question. Students should answer all questions. Part B contains 2 questions from each module of which student should answer any one. Each question can have maximum 2 sub-divisions and carry 14 marks.

Course Level Assessment Questions**Course Outcome 1 (CO1):**

1. Derive the big O notation for $f(n) = n^2 + 2n + 5$ (K2,PO1)
2. What do you understand by complexity of an algorithm? Write worst case and best case
3. Find complexity of linear search.(K2,PO1)
4. Write an algorithm for matrix multiplication and calculate its time complexity. (K3,PO2)

Course Outcome 2 (CO2)

1. Write an algorithm/pseudo code to add a new element in a particular position of an array(K3,PO2)
2. Explain about the use and representation of header node in linked list (K1,PO1)
3. How a linked list can be used to represent the polynomial $5x^4y^6 + 24x^3y^4 - 17x^2y^3 + 15xy^2 + 45$.(K3,P02)
4. What is a circular queue? How it is different from normal queue? (K1,PO1)

Course Outcome 3(CO3):

1. Compare and contrast singly linked list and doubly linked list ((K2,PO1)
2. Write a program that implement stack (its operations) using i) Arrays ii) Linked list(Pointers) and compare performance(K3,PO2)
3. Compare array and linked list implementation of a general list.(K2,P02)
4. What are the disadvantages of representing a linear queue using array? How are they overcome (K1,PO1)

Course Outcome 4 (CO4):

1. Free memory blocks of size 60K, 25K, 12K, 20K, 35K, 45K and 40K are available in this order. Show the memory allocation for a sequence of job requests of size 22K, 10K, 42K, and 31K (in this order) in First Fit, Best Fit and Worst Fit allocation strategies (K3,PO2)
2. Explain how memory de-allocation is done in memory management (K1,PO1)
3. Compare various memory management techniques (K2,PO1)

Course Outcome 5 (CO5):

1. List the properties of a binary search tree. (K1,P01)
2. Create a Binary search Tree with node representing the following sequence 14, 15, 4, 18, 9, 16, 20, 17, 3, 7, 5, 2 and perform inorder, preorder and postorder traversals on the above tree and print the output. (K3,P02)
3. Develop an algorithm to add an element into a binary search tree (K3,P02)
4. Give any two representations of graph. Give algorithm for DFS. Demonstrate DFS using suitable example. (K2,P01)

Model Question Paper

QP CODE:

PAGES : 3

Reg No: _____

Name: _____

**APJ ABDUL KALAM TECHNOLOGICAL UNIVERSITY SEVENTH SEMESTER
B.TECH
DEGREE EXAMINATION, MONTH & YEAR**

Course Code: EET443

Course Name: DATA STRUCTURES

**Max.Marks:100
Hours**

Duration: 3

PART A

Answer all Questions. Each question carries 3 Marks

1. Compare Structured Approach and Object Oriented Approach of Programming.
2. Calculate the frequency count of the statement $x = x+1$; in the following code segment

```
for (i = 0; i < n; i++)
  for (j = 0; j < n; j*=2)
    x = x + 1;
```
3. Write an Algorithm to reverse a string using Stack.
4. Explain the disadvantages of representing a Linear Queue using Array.
5. Write any three Applications of Linked List.
6. Explain DEQUEUE
7. Write a non recursive algorithm/ Pseudocode for pre-order traversal in a binary tree.

8. What is a binary search tree (BST)? Give an example of a BST with five nodes.
9. Give two different types of representation for graphs.
10. Compare Prim's and Kruskal's Algorithm

PART B

- 11.a) Explain space complexity and time complexity of an Algorithm. Write an Algorithm/pseudo code for linear search and mention the best case and worst case time complexity of Linear Search algorithm?
(10)
 - b) Explain Modular Programming with Suitable Example (4)
- OR
- 12.a) Explain System Lifecycle in detail. (10)
 - b) Explain an algorithm? How is its complexity analysed? (4)
- 13.a) Write algorithms to insert and delete elements from a double ended Queue. Demonstrate with examples (10)
 - b) Compare and Contrast a Circular Queue with a normal Queue (4)
- OR
- 14.a) Write an Algorithm to evaluate Postfix operation. (8)
 - b) Convert the following infix expression into prefix expression $(A-B/C) * (D * E - F)$. Show the stack contents for each step. (6)
- 15.a) Write algorithms to perform the following operations on a doubly linked list.
 - (i) Insert a node with data 'y' after a node whose data is 'x'.
 - (ii) Delete a node whose data is 's'.
 - (iii) Insert a node with data 'a' as the 1st node of the list. (10)
 - b) Write an algorithm to count the number of occurrences of a character in a linked list (each node contains only one character). (4)
- OR
- 16.a) Assume that a Stack is represented using Linked List. Write Algorithms for the following operations.
 - a) PUSH
 - b) POP (10)
 - b) Compare a Circular Linked List and a Doubly Linked List. (4)

17. a) Explain how memory de-allocation is done in memory management. (8)
 b) Discuss the advantages and Disadvantages of First-fit, Best-fit and Worst-fit Allocation schemes. (6)

OR

- 18.a) Write an algorithm/Pseudocode to perform the following operations on Binary Search tree.
 a) Insert an element k
 b) Search for an element k (10)
 b) Write an iterative algorithm for in-order traversal of a Binary Tree (4)
19. a) Explain the various ways in which a graph can be represented bringing out the advantages and disadvantages of each representation (10)
 b) Write an algorithm to perform bubble sort on a collection of 'n' numbers. (4)

OR

- 20.a) Give algorithms for DFS and BFS of a graph and explain with examples. (8)
 b) How graphs can be represented in a Computer? (6)

Syllabus

Module 1

Basic Concepts of Data Structures

Introduction to programming methodologies – structured approach, object oriented approach, stepwise refinement techniques, Algorithms, Performance Analysis, Space Complexity, Time Complexity, Asymptotic Notation, Complexity Calculation of Simple Algorithms

Module 2

Arrays

Introduction to data structures: Stacks, Queues-Circular Queues, Priority Queues, Double Ended Queues, Evaluation of Expressions, Applications of stacks and queues

Module 3

Linked List

Singly Linked List-Operations on Linked List. Doubly Linked List, Circular Linked List, Stacks and Queues using Linked List, Polynomial representation using Linked List

Module 4*Memory Management and Trees*

Memory Management - Memory allocation and de-allocation-First-fit, Best-fit and Worst-fit allocation schemes

Trees, Binary Trees-Tree Operations, Binary Tree Representation, Tree Traversals, Binary Search Trees- Binary Search Tree Operations

Module 5*Graphs*

Graphs : Definitions, Representation of Graphs, Topological Sort, Depth First Search and Breadth First Search on Graphs, Shortest-path algorithms, Minimum spanning tree, Prim's and Kruskal's algorithms, Applications of graphs

Text Book

1. Fundamentals of Data structures in C, 2nd Edition, E.Horowitz, S.Sahni and Susan Anderson-Freed, University Press (India),2008.

Reference Books

1. Classic Data Structures, Samanta D., Prentice Hall India, 2/e,,2009.
2. Data Structures: A Pseudocode Approach with C, 2/e, Richard F. Gilberg, Behrouz A. Forouzan, Cengage Learning 2005.
3. Data Structures and Algorithms, Aho A. V., J. E. Hopcroft and J. D. Ullman Pearson Publication. 2nd Edition
5. Introduction to Data Structures with Applications, Tremblay J. P. and P. G. Sorenson,Tata McGraw Hill 1995
4. Advanced Data Structures, Peter Brass ,Cambridge University Press,2008
5. Theory and Problems of Data Structures, Lipschuts S., Schaum's Series 1996
6. 8A Structured Approach to Programming, . Hugges J. K. and J. I. Michtm, PHI. 1987

Course Contents and Lecture Schedule:

No	Topic	No. of Lectures
1	Introduction	5
1.1	Introduction to programming methodologies – structured approach, object oriented approach, stepwise refinement techniques\	1
1.2	Algorithms , Performance Analysis	1
1.3	Space Complexity, Time Complexity	1
1.4	Asymptotic Notation (Big O Notation)	1

1.5	Complexity Calculation of Simple Algorithms	1
2	Arrays	7
2.1	Stacks	1
2.2	Queues, Circular Queues	1
2.3	Priority Queues	1
2.4	Double Ended Queues	1
2.5	Conversion and Evaluation of Expressions	1
2.6	Applications of stacks and queues	2
3	Linked List	8
3.1	Singly Linked List	1
3.2	Doubly Linked List	1
3.3	Circular Linked List	1
3.4	Stacks using Linked List	1
3.5	Queues using Linked List	1
3.6	Polynomial representation using Linked List	2
4	Memory Management and Trees	8
4.1	Memory allocation and de-allocation	1
4.2	First-fit, Best-fit and Worst-fit allocation schemes	2
4.3	Binary Trees- Tree Operations	1
4.4	Binary Tree Representation, Tree Traversals	2
4.5	Binary Search Trees- Binary Search Tree Operations	2
5	Graphs	7
5.1	Graphs Definitions, Representation of Graphs	1
5.2	Topological sort, Depth First Search and Breadth First Search on Graphs,	2

5.3	Shortest-path algorithms,	1
5.4	Minimum spanning tree	1
5.5	Prim's and Kruskal's algorithms, Applications of graphs	2

APJ ABDUL KALAM
TECHNOLOGICAL
UNIVERSITY

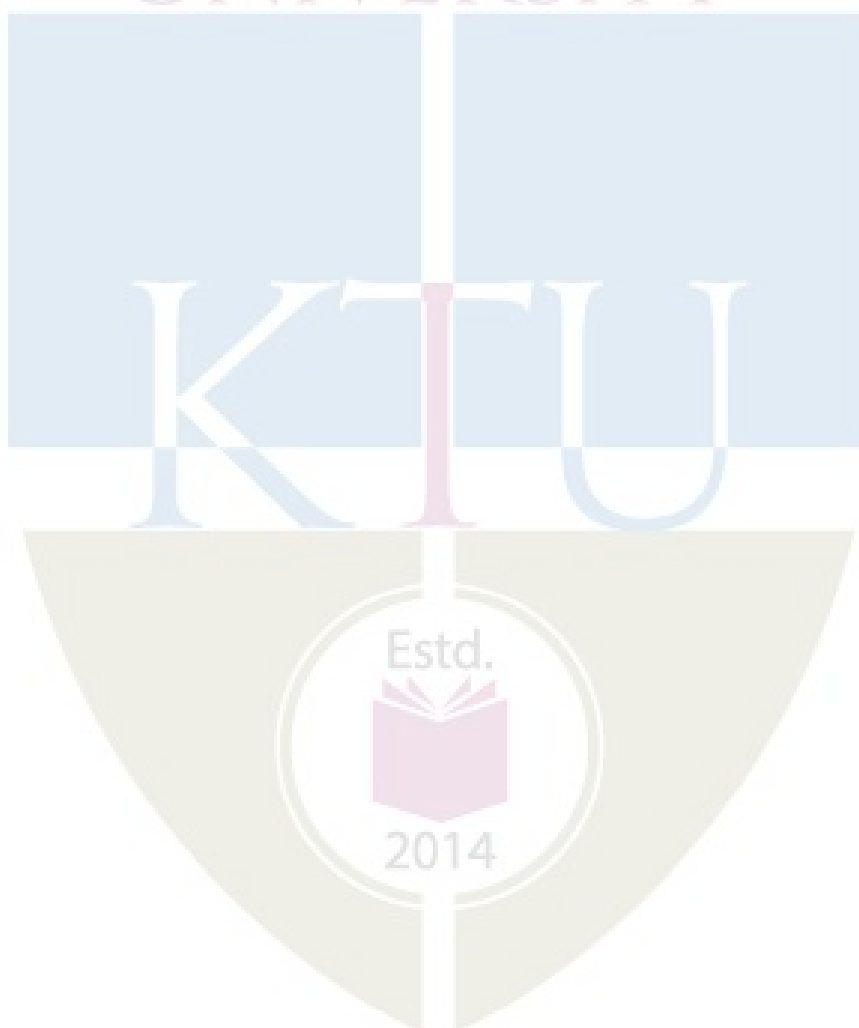

CODE	COURSE NAME	CATEGORY	L	T	P	CREDIT
EET453	DIGITAL SIGNAL PROCESSING	PEC	2	1	0	3

Preamble: This course introduces the discrete Fourier transform (DFT) and its computation using direct method and fast Fourier transform (FFT). Techniques for designing infinite impulse response (IIR) and finite impulse response (FIR) filters from given specifications are also introduced. Various structures for realization of IIR and FIR filters are discussed. Detailed analysis of finite word-length effects in fixed point DSP systems is included. Architecture of a digital signal processor is also discussed.

Prerequisite : EET305 - Signals and Systems

Course Outcomes: After the completion of the course the student will be able to

CO 1	Compute Discrete Fourier transform and Fast Fourier transform .
CO 2	Discuss the various structures for realization of IIR and FIR discrete-time systems.
CO 3	Design IIR (Butterworth and Chebyshev) digital filters using impulse invariant and bilinear transformation methods.
CO 4	Design FIR filters using frequency sampling method and window function method.
CO 5	Compare fixed point and floating point arithmetic used in digital signal processors and discuss the finite word length effects.
CO 6	Explain the architecture of digital signal processors and the applications of DSP.

Mapping of course outcomes with program outcomes

	PO1	PO2	PO3	PO4	PO5	PO6	PO7	PO8	PO9	PO10	PO11	PO12
CO 1	3	2	-	2	2	-	-	-	-	-	-	2
CO 2	3	2	-	2	2	-	-	-	-	-	-	2
CO 3	3	2	-	2	2	-	-	-	-	-	-	2
CO 4	3	2	-	2	2	-	-	-	-	-	-	2
CO 5	3	2	-	-	2	-	-	-	-	-	-	2
CO 6	3	-	2	-	2	2	-	-	-	-	-	3

Assessment Pattern

Bloom's Category	Continuous Assessment Tests		End Semester Examination
	1	2	
Remember (K1)	10	10	10
Understand (K2)	10	10	30
Apply (K3)	30	30	60
Analyse (K4)			
Evaluate (K5)			
Create (K6)			

Mark distribution

Total Marks	CIE	ESE	ESE Duration
150	50	100	3 hours

Continuous Internal Evaluation Pattern:

Attendance	: 10 marks
Continuous Assessment Test (2 numbers)	: 25 marks
Assignment/Quiz/Course project	: 15 marks

End Semester Examination Pattern: There will be two parts; Part A and Part B. Part A contain 10 questions with 2 questions from each module, having 3 marks for each question. Students should answer all questions. Part B contains 2 questions from each module of which student should answer any one. Each question can have maximum 2 sub-divisions and carry 14 marks.

Course Level Assessment Questions**Course Outcome 1 (CO1)**

1. State and prove various properties of DFT - (K1, PO1,PO2,PO12)
2. Determine the linear convolution using DFT – (K2,PO1,PO2,PO4,PO5,PO12)
3. Determine the linear convolution using overlap-add and overlap-save method – (K3,PO1,PO2,PO4,PO5)
4. Compute DFT using DIT FFT and DIF FFT – (K2,PO1,PO2,PO4,PO5)

Course Outcome 2 (CO2)

1. Determine the structures for direct form, cascade, parallel, transposed and lattice-ladder realisations of IIR systems –(K2,PO1,PO2,PO4,PO5,PO12)
2. Determine the structures for direct form, cascade, lattice ,and linear phase realizations of FIR systems – (K2,PO1,PO2,PO4,PO5)

Course Outcome 3(CO3)

1. Design IIR digital LP/HP/BP/BS filter using Butterworth and Chebyshev methods – (K3,PO1,PO2,PO4,PO5)
2. Transform $H(s)$ to $H(z)$ using impulse invariant technique and bilinear transformation – (K2,PO1,PO2,PO4,PO5,PO12)

Course Outcome 4 (CO4)

1. Design FIR digital LP/HP/BP/BS filter using frequency sampling method – (K3,PO1,PO2,PO4,PO5,PO12)
2. Design FIR digital LP/HP/BP/BS filter using window function – (K3,PO1,PO2,PO4,PO5)

Course Outcome 5 (CO5)

1. Differentiate between fixed-point arithmetic and floating point arithmetic - (K2,PO1,PO2,PO12)
2. Explain various finite word length effects in fixed point DSP processors.- (K2,PO1,PO2)
3. Problems to determine steady state output noise power and round-off noise power – (K3,PO1,PO2)
4. Explain limit cycle oscillations and methods for its elimination - (K2,PO1,PO2)

Course Outcome 6 (CO6)

1. Explain Harvard architecture –(K1,PO1,PO5,PO12)
2. Describe the architecture of a fixed-point DSP processor – (K1,PO1,PO5)
3. List various applications of digital signal processor – (K3,PO1,PO3,PO6)

Model Question Paper

PAGES: 3

QPCODE:

Reg. No: _____

Name: _____

**APJ ABDUL KALAM TECHNOLOGICAL UNIVERSITY
SEVENTH SEMESTER B. TECH DEGREE EXAMINATION
MONTH & YEAR**

Course Code: **EET453**Course Name: **DIGITAL SIGNAL PROCESSING****Max. Marks: 100****Duration: 3 Hours**

Estd.

PART A**Answer all Questions.****Each question carries 3 Marks**

- 1 List any 3 properties of DFT.
The first 5 points of the 8-point DFT of a real valued sequence are
- 2 $X(k) = \{0.25, 0.125 - j0.3, 0, 0.125 - j0.05, 0\}$. Determine the remaining 3 points.
Obtain direct form 1 realization for a digital IIR system described by the
- 3 system function, $H(z) = \frac{z+0.2}{z^2+0.5z+1}$.
- 4 Obtain realization with minimum number of multipliers for the system function $H(z) = \frac{1}{2} + z^{-1} + \frac{1}{2}z^{-2}$.

- 5 Explain warping effect in bilinear transformation.
- 6 Determine the order of a Chebyshev analog lowpass filter with a maximum passband attenuation of 2.5dB at $\Omega_p = 20$ rad/sec and the stopband attenuation of 30dB at $\Omega_s = 50$ rad/sec.
- 7 What are the desirable characteristics of a window function used for truncating the infinite impulse response?
- 8 Represent the numbers i) +4.5 and ii) -4.5 in IEEE 754 single-precision floating point format.
- 9 List any 3 finite-word length effects in a fixed point digital signal processor.
- 10 Draw the block diagram of a basic Harvard architecture in digital signal processor.

PART B

Answer any one full question from each module.

Each question carries 14 Marks

Module 1

- 11 a) Find the 4-point DFT of the sequence, $x(n) = \{1, -1, 1, -1\}$. Also, using time shift property, find the DFT of the sequence, $y(n) = x((n-2))_4$. (7)
- b) Two finite duration sequences are $h(n) = \{1, 0, 1\}$ (7) and $x(n) = \{-1, 2, -1, 0, 1, 3, -2, 1, -3, -2, -1, 0, -2\}$. Use overlap-save method, to find $y(n) = x(n) * h(n)$.

OR

- 12 Compute IDFT of the sequence (14)
 $X(k) = \{7, -0.707 - j0.707, -j, 0.707 - j0.707, 1, 0.707 + j0.707, j, -0.707 + j.707\}$ using DIT FFT.

Module 2

- 13 a) Realize the system function in cascade form $H(z) = \frac{1 + \frac{1}{3}z^{-1}}{1 - \frac{3}{4}z^{-1} + \frac{1}{8}z^{-2}}$. (6)
- b) Determine the direct form 2 and transposed direct form structure for the given system $y(n) = \frac{1}{2}y(n-1) - \frac{1}{4}y(n-2) + x(n) + x(n-1)$. (8)

OR

- 14 a) Obtain the direct form realization of linear phase FIR system given by (7)
 $H(z) = 1 + \frac{3}{4}z^{-1} + \frac{17}{8}z^{-2} + \frac{3}{4}z^{-3} + z^{-4}$
- b) Determine the coefficients k_m of the lattice filter corresponding to FIR filter (7) described by the system function $H(z) = 1 + 2z^{-1} + \frac{1}{3}z^{-2}$. Also, draw the corresponding second order lattice structure

Module 3

- 15 a) Find $H(z)$ using impulse invariant transformation. (7)

$$H(s) = \frac{1}{s^2 + \sqrt{2}s + 1}; \quad T = 1 \text{ sec.}$$

- b) A Butterworth lowpass filter has to meet the following specifications. (7)

i) Passband gain = -3dB at $f_p = 500\text{Hz}$

ii) Stopband attenuation greater than or equal to 40dB at $f_s = 1000\text{Hz}$

Determine the order of the Butterworth filter to meet the above specifications. Also, find the cut off frequency.

OR

- 16 Design a Chebyshev digital lowpass filter with a maximum passband attenuation of 2dB at 100Hz and minimum stopband attenuation of 20dB at 500Hz. Sampling rate is 4000 samples/sec. Use bilinear transformation. (14)

Module 4

- 17 a) Design a linear phase lowpass FIR filter with $N = 7$ and a cut-off frequency 0.3π radian using the frequency sampling method. (7)

- b) A linear phase FIR filter has frequency response $H(\omega) = \cos \frac{\omega}{2} + \frac{1}{2} \cos \frac{3\omega}{2}$ (7)

Determine the impulse response $h(n)$.

OR

- 18 A band stop filter is to be designed with the following desired frequency (14)

$$\text{response } H_d(e^{j\omega}) = \begin{cases} e^{-j\omega\alpha} & -\omega_{c1} \leq \omega \leq \omega_{c1} \quad \omega_{c2} \leq |\omega| \leq \pi \\ 0 & \text{otherwise} \end{cases}$$

Design with $N = 7$, $\omega_{c1} = \pi/4$ rad/sec, $\omega_{c2} = 3\pi/4$ rad/sec using rectangular window.

Module 5

- 19 a) Compare between fixed point and floating point digital signal processors. (6)

- b) The output of an ADC is applied to a digital filter with system function (8)

$$H(z) = \frac{0.5z}{(z-0.5)}$$

Find the output noise power from digital filter when input signal is quantized to have 8 bits.

OR

- 20 a) Draw and explain the architecture of any fixed-point DSP processor. (8)

- b) Explain the techniques used to prevent overflow in fixed-point DSP operations. (6)

Module 1 - DISCRETE-FOURIER TRANSFORM

Review of signals and systems - Frequency domain sampling - Discrete Fourier transform (DFT) – inverse DFT (IDFT) - properties of DFT – linearity, periodicity, symmetry, time reversal, circular time shift, circular frequency shift, circular convolution, complex conjugate property – Filtering of long data sequences – over-lap save method, over-lap add method – Fast Fourier transform (FFT) – advantages over direct computation of DFT - radix -2 decimation-in-time FFT (DITFFT) algorithm, Radix-2 decimation-in-frequency FFT (DIFFFT) algorithm.

Module 2 - REALIZATION OF IIR AND FIR SYSTEMS

Introduction to FIR and IIR systems - Realization of IIR systems – direct form 1, direct form 2, cascade form, parallel form, lattice structure for all-pole system, lattice-ladder structure – conversion of lattice to direct form and vice-versa - signal flow graphs and transposed structures – Realization of FIR systems – direct form, cascade form, lattice structure, linear phase realization.

Module 3 - IIR FILTER DESIGN

Conversion of analog transfer function to digital transfer function – impulse invariant transformation and bilinear transformation – warping effect

Design of IIR filters – low-pass, high-pass, band-pass, band-stop filters – Butterworth and Chebyshev filter – frequency transformation in analog domain - design of LP, HP, BP, BS IIR digital filters using impulse invariance and bilinear transformation.

Module 4 - FIR FILTER DESIGN AND REPRESENTATION OF NUMBERS

Impulse response of ideal low pass filter – linear phase FIR filter – frequency response of linear phase FIR filter – Design of FIR filter using window functions (LP, HP, BP, BS filters) – Rectangular, Bartlett, Hanning, Hamming and Blackmann only – FIR filter design based on frequency sampling approach (LP, HP, BP, BS filters)

Representation of numbers – fixed point representation – sign-magnitude, one's complement, two's complement – floating point representation – IEEE 754 32-bit single precision floating point representation

Module 5 - FINITE WORD LENGTH EFFECTS AND DIGITAL SIGNAL PROCESSORS

Finite word length effects in digital Filters – input quantization – quantisation noise power – steady-state output noise power – coefficient quantisation – overflow – techniques to prevent overflow - product quantization error – rounding and truncation – round-off noise power – limit cycle oscillations – zero input limit cycle oscillations – overflow limit cycle oscillations – signal scaling.

Digital signal processor architecture based on Harvard architecture (block diagram) – Harvard architecture, pipelining, dedicated hardware multiplier/accumulator, special instructions dedicated to DSP, replication, on-chip memory cache, extended parallelism

(Reference [2]) - comparison of fixed-point and floating-point processor – applications of DSP

Text Books

1. John G. Proakis & Dimitris G. Manolakis, “Digital Signal Processing Principles, Algorithms & Applications”, Pearson

Reference Books

1. Emmanuel Ifeachor & Barrie W. Jervis, “Digital Signal Processing”, Pearson, 13th edition, 2013
2. P. Ramesh Babu, “Digital Signal Processing”, Scitech Publications (India) Pvt Ltd, 2nd edition, 2003
3. Li Tan, “Digital Signal Processing, Fundamentals & Applications”, Academic Press, 1st edition, 2008
4. D. Ganesh Rao & Vineeta P. Gejji, “Digital Signal Processing, A Simplified Approach”, Sanguine Technical Publishers, 2nd edition, 2008

Course Contents and Lecture Schedule

Sl. No	Topic	No. of Lectures
1	DISCRETE-FOURIER TRANSFORM (7 hours)	
1.1	Review of signals, systems and discrete-time Fourier transform (DTFT), Frequency domain sampling, discrete-Fourier transform (DFT), twiddle factor, inverse DFT, properties of DFT - linearity, periodicity, symmetry, time reversal, circular time shift, circular frequency shift, circular convolution, complex conjugate property	3 hours
1.2	Linear filtering using DFT, linear filtering of long data sequences, overlap-save method, overlap-add method	1 hour
1.3	Fast Fourier transform (FFT) – comparison with direct computation of DFT - radix -2 decimation-in-time FFT (DITFFT) algorithm – bit reversal - Radix-2 decimation-in-frequency FFT (DIFFFT) algorithm	3 hours
2	REALIZATION OF IIR AND FIR SYSTEMS (7 hours)	
2.1	Introduction to FIR and IIR systems - comparison - Realization of IIR systems – direct form 1, direct form 2, cascade form, parallel form	3 hours
2.2	Lattice structure for all-pole system - lattice-ladder structure – conversion of lattice to direct form and vice-versa signal flow graphs and transposed structures	2 hours
2.3	Realization of FIR systems – direct form, cascade form, lattice structure, linear phase realization.	2 hours
3	IIR FILTER DESIGN (7 hours)	
3.1	Conversion of analog transfer function to digital transfer function – impulse invariant transformation and bilinear transformation – warping effect	2 hours
3.2	Design of IIR filters – characteristics of ideal and practical low-pass, high-pass, band-pass, band-stop filters – design of Butterworth filter –	3 hours

	normalised analog filter - frequency transformation in analog domain - design of LP, HP, BP, BS IIR digital filters using impulse invariance and bilinear transformation.	
3.3	Design of Chebyshev filter – design of LP, HP, BP, BS IIR digital filters using impulse invariance and bilinear transformation	2 hours
4	FIR FILTER DESIGN AND REPRESENTATION OF NUMBERS (7 hours)	
4.1	Impulse response of ideal low pass filter – linear phase FIR filter – frequency response of linear phase FIR filter – Design of FIR filter using window function (LP, HP, BP, BS filters) – Rectangular, Bartlett, Hanning, Hamming and Blackmann only	3 hours
4.2	FIR filter design based on frequency sampling approach (LP, HP, BP, BS filters)	2 hours
4.3	Representation of numbers – fixed point representation – sign-magnitude, one’s complement, two’s complement – floating point representation – IEEE 754 32-bit single precision floating point representation	2 hours
5	FINITE WORD LENGTH EFFECTS AND DIGITAL SIGNAL PROCESSORS (7 hours)	
5.1	Finite word length effects in digital Filters – input quantization – quantisation noise power – steady-state output noise power	2 hours
5.2	Coefficient quantisation – overflow – techniques to prevent overflow - product quantization error – rounding and truncation – round-off noise power	1 hour
5.3	Limit cycle oscillations – zero input limit cycle oscillations – overflow limit cycle oscillations – signal scaling.	1 hour
5.4	Digital signal processor architecture based on Harvard architecture (block diagram) – Harvard architecture, pipelining, dedicated hardware multiplier/accumulator, special instructions dedicated to DSP, replication, on-chip memory cache, extended parallelism (Reference [1])	2 hours
5.5	Comparison of fixed-point and floating-point processor – applications of digital signal processor	1 hour

Note: Preferable list of computer based assignments

Assignments using signal processing tool of MATLAB/SCILAB etc	
1	Determine 4-point/8-point DFT/IDFT of any sequence by direct computation
2	Compute 4-point/8-point DFT/IDFT using DIT FFT and DIF FFT algorithms.
3	Find the linear convolution and circular convolution of two sequences.
4	Find the linear convolution using overlap-add and overlap-save methods.
5	Determine 2 stage/3 stage lattice ladder coefficients if the system function of IIR direct form is given.
6	Obtain coefficients of IIR direct form from lattice ladder form.
7	Transform an analog filter into digital filter using impulse invariant technique/bilinear transformation.
8	Calculate the order and cut-off frequency of a low pass Butterworth filter
9	Obtain the frequency response and filter coefficients of a LP/HP/BP/BS IIR

	Butterworth filter	ELECTRICAL AND ELECTRONICS
10	Obtain the frequency response and filter coefficients of a LP/HP/BP/BS IIR Chebyshev filter	
11	Compute LP/HP/BP/BS FIR filter coefficients using rectangular/Bartlett/Hamming/Hanning/Blackmann window	

APJ ABDUL KALAM
TECHNOLOGICAL
UNIVERSITY

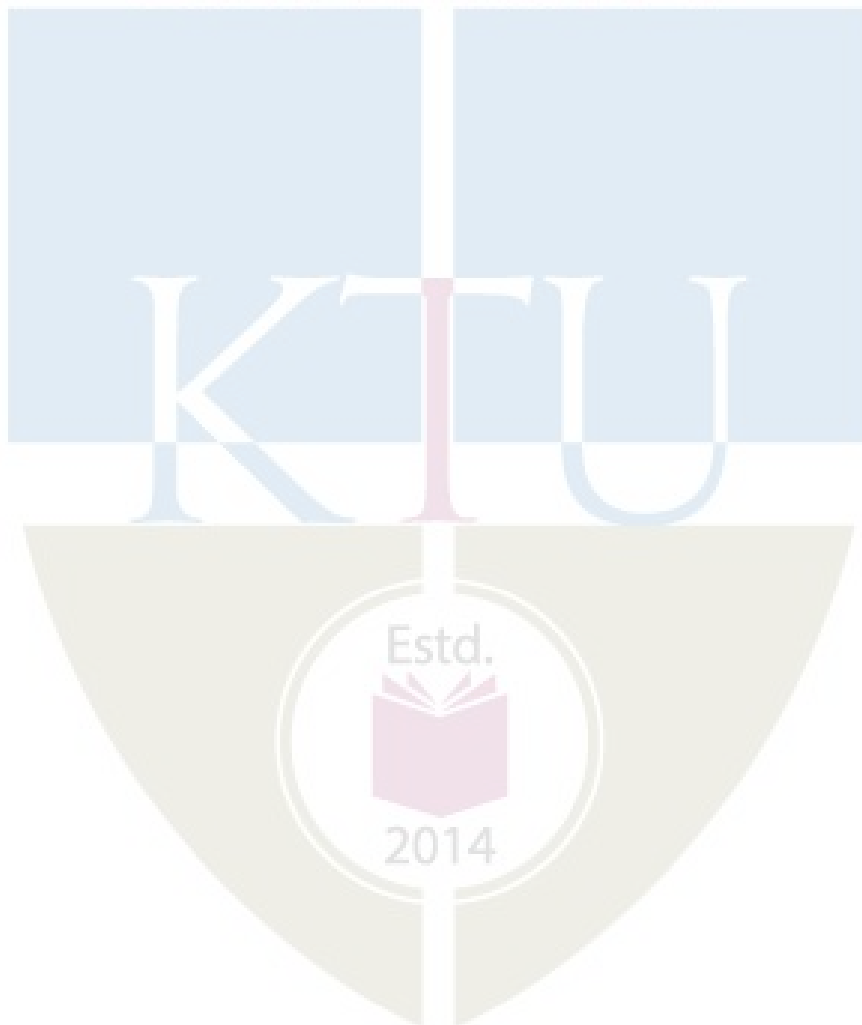

CODE	COURSE NAME	CATEGORY	L	T	P	CREDIT
EET463	ILLUMINATION TECHNOLOGY	PEC	2	1	0	3

Preamble: The basic objective of this course is to deliver the fundamental concepts of illumination engineering in the analysis and design of architectural lighting systems.

Prerequisite: Nil

Course Outcomes: After the completion of the course the student will be able to

CO 1	Explain the fundamental concepts of natural and artificial lighting schemes
CO 2	Design efficient indoor lighting systems
CO 3	Design efficient outdoor lighting systems
CO 4	Describe aesthetic and emergency lighting systems

Mapping of course outcomes with program outcomes

	PO 1	PO 2	PO 3	PO 4	PO 5	PO 6	PO 7	PO 8	PO 9	PO 10	PO 11	PO 12
CO 1	3	2										
CO 2	2	2	3				1					1
CO 3	2	2	3				1					1
CO 4	2	2			3							

Assessment Pattern

Bloom's Category	Continuous Assessment		End Semester Examination
	Tests		
	1	2	
Remember	15	15	30
Understand	15	15	30
Apply	20	20	40
Analyse			
Evaluate			
Create			

Mark distribution

Total Marks	CIE	ESE	ESE Duration
150	50	100	3 hours

Continuous Internal Evaluation Pattern:

ELECTRICAL AND ELECTRONICS

Attendance	: 10 marks
Continuous Assessment Test (2 numbers)	: 25 marks
Assignment/Quiz/Course project	: 15 marks

End Semester Examination Pattern: There will be two parts; Part A and Part B. Part A contain 10 questions with 2 questions from each module, having 3 marks for each question. Students should answer all questions. Part B contains 2 questions from each module of which student should answer any one. Each question can have maximum 2 sub-divisions and carry 14 marks.

Course Level Assessment Questions**Course Outcome 1 (CO1):**

1. Explain the quality of a good lighting (K2 PO1)
2. Select the factors affecting the quality of artificial lighting (K2 PO2)
3. Define MHCP, MSCP. (K1 PO1)

Course Outcome 2 (CO2)

1. Define Maintenance Factor.(K1 PO1)
2. Problems related to design of indoor lighting systems.(K2 PO2 PO3 PO7)
3. What are the special features that must be taken care of while illuminating staircase. (K2 PO2 PO12)

Course Outcome 3(CO3):

1. Select the main factors for designing street/road lighting? .(K2 PO2 PO3 PO12)
2. Problems related to design of Flood Lighting system?(K2 PO2 PO3 PO7)
3. With a neat diagram give the application of Track Fixtures.(K2 PO2 PO3)

Course Outcome 4 (CO4):

1. Explain at least Five features of monument lighting.(K2 PO1 PO2)
2. What are the different factors to be considered while designing aesthetic illumination of bridges and statues? .(K2 PO1 PO2 PO5)
3. Selection of luminaries for different areas in hospitals? .(K2 PO1 PO2 PO5)

Model Question Paper

ELECTRICAL AND ELECTRONICS

QP CODE:

PAGES:

Reg No: _____

Name : _____

**APJ ABDUL KALAM TECHNOLOGICAL UNIVERSITY
SEVENTH SEMESTER B.TECH DEGREE EXAMINATION,
MONTH & YEAR**

Course Code: EET463

Course Name: ILLUMINATION TECHNOLOGY

Max. Marks: 100

Duration: 3 Hours

PART A (10X3=30marks)

Answer all Questions. Each question carries 3 Marks

1. What are the different schemes of artificial lighting?
2. Explain with neat diagram the different types of artificial lighting system used.
3. Explain how photometric bench is used for measuring candle power of a test lamp
4. Explain how illumination can be calculated for Line source and Surface source.
5. Illustrate at least five fixtures used for outdoor lighting?
6. Define Space to Mounting height ratio
7. How are the projectors in flood lighting classified according to the beam?
8. What are different methods available for aiming the lamp in flood lighting?
9. List out the requirements of a good Sport lighting.
10. List out and explain at least five features of auditorium lighting

PART B

Answer any one full question from each module. Each question carries 14 Marks

Module-1

11(a) What is the impact of stroboscopic effect on visual comfort in an artificial lighting scheme? How the effect can be reduced

11(b) Explain with neat diagram the different types of artificial lighting system used.

12(a) Explain Colour rendering and stroboscopic effect

12(b) What is a glare? How it is classified.

Module-2

13(a) Four lamps 15m apart are arranged to illuminate a corridor. Each lamp is mounted at a height of 8m above the floor level. Each lamp gives 450 Cd in all directions below the horizontal. Find the illumination at the midway between 2nd and 3rd lamp

13(b) Illustrate with a neat diagram the concept of polar curve in illumination technology

14(a) State the Laws of Illumination

14(b) Explain with neat figures a.) Inverse square law b.) Lambert's Cosine law

Module-3

15(a) Specify the need of DLOR and ULOR in artificial architectural lighting. List out three factors on which DLOR and ULOR depends

15(b) Illustrate at least five fixtures used for interior lighting?

16(a) Define

1. Coefficient of utilisation
2. Depreciation factor

16(b) A drawing hall in an engineering college is to be illuminated with a lighting installation. The hall is $30\text{m} \times 20\text{m} \times 8\text{m}$ (high). The mounting height is 5m and the required level of illumination is 144 lm/m^2 . Using metal filament lamps, estimate the size and number of single lamp luminaries and draw their spacing layout. Assume: Utilization factor = 0.6, MF = 0.75; Space/Height = 1. Lumens/ Watt for 300-W lamp = 13, Lumens/Watt for 500-W lamp = 16

Module-4

17(a) How are the projectors in flood lighting classified according to the beam?

17 b) Describe the area of application of each type of flood light.

18(a) Illustrate at least five fixtures used for outdoor lighting?

18(b) Explain the various types of lamps used in street lighting.

Module-5

19a) What are different factors to be considered while designing aesthetic illumination of bridges and statues?

19 b) What is the importance of modelling and shadows in the case of sports field lighting?

20 a) Describe any five characteristics of statue lighting

20(b) During the Onam week celebration organised by the Dept. of Tourism, it is a customary to illuminate the Kerala Secretariat Building and the arterial road in the capital city in different colours. As an illumination engineer what are the different factors which must be considered for

- i) Illuminating the Secretariat building
- ii) The roads way aesthetic lighting
- iii) A Statue in front of Secretariat building

Syllabus

Module 1

Introduction of Light: Types of illumination, Day lighting, Artificial light sources- artificial lighting and total lighting, Quality of good lighting, Factors affecting the Physical processes- Incandescent and Halogen lamps, Fluorescent lamps, LPSV and HPSV lamps, mercury vapour lamps, metal halide lamps, LED lamps- modern trends. Supplementary lighting- shadow, glare, reflection, Colour rendering and stroboscopic effect, Methods of artificial lighting, Lighting systems- direct, indirect, semi direct, semi indirect, Lighting scheme, General and localised, Different types of Luminaires

Module 2

Measurement of Light: Definition of luminous flux, Luminous intensity, Lumen, Candle power, Illumination, M.H.C.P, M.S.C.P, M.H.S.C.P, Lamp efficiency, Brightness or luminance, Laws of illumination, Inverse square law and Lambert's Cosine law, Illumination at horizontal and vertical plane from point source, Concept of polar curve, Calculation of luminance and illumination in case of linear source, round source and flat source. Measuring apparatus- Goniophotometer, Integrating sphere, lux meter.

Module 3

Design of Interior Lighting: Definitions of maintenance factor, Uniformity ratio, Direct ratio, Coefficients of utilisation and factors affecting it, Illumination required for various work planes, Types of fixtures and relative terms used for interior illumination such as DLOR and ULOR, Selection of lamp and luminance, Selection of utilisation factor, reflection factor and maintenance factor, Determination of Lamp Lumen output taking into account voltage and temperature variations, Calculation of wattage of each lamp and no of lamps needed, Layout of lamp luminaire, Calculation of space to mounting height ratio, Indian standard recommendation and standard practices for illumination levels in various areas, Special feature for entrance, staircase, Corridor lighting and industrial building.

Module 4

Design of Outdoor Lighting: Street Lighting - Types of street and their level of illumination required, Terms related to street lighting, Types of fixtures used and their suitable application, Various arrangements in street lighting, Requirements of good street lighting, Selection of lamp and luminaire, Calculation of illumination level available on road. Tunnel

Lighting, Calculation of their wattage and number and their arrangement, Calculation of space to mounting height ratio.

Flood Lighting: Terms related to flood lighting, Types of fixtures and their suitable applications, Selection of lamp and projector, recommended method for aiming of lamp, Calculation of their wattage and number and their arrangement, Calculation of space to mounting height ratio.

Module 5

Special Features of Aesthetic Lighting: Monument and statue lighting, Sports lighting, Hospital lighting, Auditorium lighting

General Aspects of emergency lighting. Lighting controllers – dimmers, motion and occupancy sensors, photo sensors and timers. Lighting system design using software (eg: DIALux and Relux).

Note: Case study of indoor and outdoor lighting design using software may be given as assignment.

Text Books

1. D.C. Pritchard Lighting, Routledge, 2016
2. Jack L. Lindsey, Applied Illumination Engineering, PHI, 1991

References:

1. John Matthews Introduction to the Design and Analysis of Building Electrical Systems, Springer, 1993
2. M.A. Cayless, Lamps and Lighting , Routledge, 1996
3. Craig DiLouie, Advanced Lighting Controls: Energy Savings, Productivity, Technology and Applications, CRC Press, 2005.
4. Lighting Engineering Applied calculations R. H. Simons and A. R. Bean, Routledge; 1st edition, 2020

Course Contents and Lecture Schedule

No	Topic	No. of Lectures
1	Introduction of Light (7 hours)	
1.1	Types of illumination, Day lighting.	1
1.2	Artificial light sources-Physical processes- Incandescent and Halogen lamps, Fluorescent lamps, LPSV and HPSV lamps, mercury vapour lamps, metal halide lamps, LED lamps- modern trends.	2
1.3	Supplementary artificial lighting and total lighting, Quality of good lighting, Factors affecting the lighting-shadow, glare, reflection, Colour	2

	rendering and stroboscopic effect.	
1.4	Methods of artificial lighting, Lighting systems-direct, indirect, semi direct, semi indirect, Lighting scheme, General and localised, Different types of Luminaires.	2
2	Measurement of Light. (7 hours)	
2.1	Definition of luminous flux, Luminous intensity, Lumen, Candle power, Illumination, M.H.C.P, M.S.C.P, M.H.S.C.P, Lamp efficiency, Brightness or luminance.	2
2.2	Laws of illumination, Inverse square law and Lambert's Cosine law, Illumination at horizontal and vertical plane from point source.	2
2.3	Concept of polar curve, Calculation of luminance and illumination in case of linear source, round source and flat source.	2
2.4	Measuring apparatus- Goniophotometer, Integrating sphere, lux meter.	1
3	Design of Interior Lighting (8 Hours)	
3.1	Definitions of maintenance factor, Uniformity ratio, Direct ratio, Coefficients of utilisation and factors affecting it, Illumination required for various work planes.	2
3.2	Types of fixtures and relative terms used for interior illumination such as DLOR and ULOR, Selection of lamp and luminance, Selection of utilisation factor, reflection factor and maintenance factor.	2
3.3	Determination of Lamp Lumen output taking into account voltage and temperature variations, Calculation of wattage of each lamp and no of lamps needed, Layout of lamp luminaire, Calculation of space to mounting height ratio.	2
3.4	Indian standard recommendation and standard practices for illumination levels in various areas, Special feature for entrance, staircase, Corridor lighting and industrial building.	2
4	Design of Outdoor Lighting (10 Hours)	
4.1	Street Lighting - Types of street and their level of illumination required, Terms related to street and street lighting, Types of fixtures used and their suitable application.	2
4.2	Various arrangements in street lighting, Requirements of good street lighting, Selection of lamp and luminaire, Calculation of illumination level available on road. Calculation of their wattage and number and their arrangement, Calculation of space to mounting height ratio.	2
4.3	Tunnel Lighting, Calculation of their wattage and number and their	2

	arrangement, Calculation of space to mounting height ratio.	
4.4	Flood Lighting: Terms related to flood lighting, Types of fixtures and their suitable applications, Selection of lamp and projector, Recommended method for aiming of lamp.	2
4.5	Flood Lighting: Calculation of their wattage and number and their arrangement, Calculation of space to mounting height ratio.	2
5	Special Features of Aesthetic and Emergency lighting (6 Hours)	
5.1	Monument and statue lighting, Sports lighting	2
5.2	Hospital lighting, Auditorium lighting	1
5.3	General Aspects of emergency lighting, Lighting controllers – dimmers, motion and occupancy sensors, photo sensors and timers	2
5.4	Lighting system design using software	1

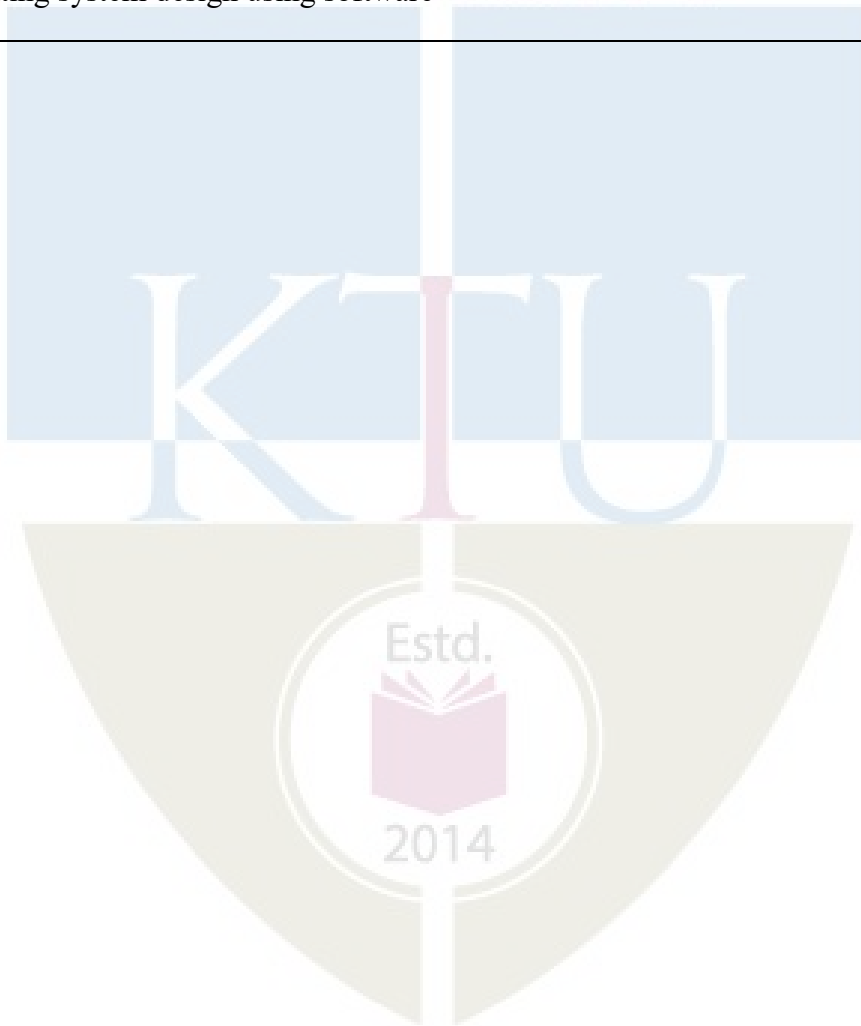

CODE	COURSE NAME	CATEGORY	L	T	P	CREDIT
EET473	DIGITAL PROTECTION OF POWER SYSTEMS	PEC	2	1	0	3

Preamble: The basic objective of this course is to deliver fundamental concepts to design various electronic circuits to implement various relaying functions. The relays such as Static Relays, Microprocessor based protective relays, Digital relay Travelling wave based protection and adaptive relaying is comprehensively covered in this course. It should be also useful to practicing engineers and the research community.

Prerequisite : 1) EET 301 Power Systems I
2) EET 304 Power Systems II

Course Outcomes: After the completion of the course the student will be able to

CO 1	Identify the relay protection scheme suitable for over current, differential and distance protection.
CO 2	Develop the protection scheme for bus bars, transformers, generators, motors and distribution systems using appropriate protective relays.
CO 3	Illustrate the operation of a numerical relay in his/her own way.
CO 4	Explain signal processing methods and algorithms in digital protection.
CO 5	Infer emerging protection schemes in power systems.

Mapping of course outcomes with program outcomes

	PO 1	PO 2	PO 3	PO 4	PO 5	PO 6	PO 7	PO 8	PO 9	PO 10	PO 11	PO 12
CO 1	3	2	-	-	-	-	-	-	-	-	-	-
CO 2	3	3	3	-	-	-	-	-	-	-	-	-
CO 3	3	2	3	-	-	-	-	-	-	-	-	-
CO 4	3	2	3	-	-	-	-	-	-	-	-	-
CO 5	3	3	-	2	-	-	-	-	-	-	-	-

Assessment Pattern

Bloom's Category	Continuous Assessment Tests		End Semester Examination
	1	2	
Remember	10	10	30
Understand	20	20	40
Apply	20	20	30
Analyse			
Evaluate			
Create			

Mark distribution

Total Marks	CIE	ESE	ESE Duration
150	50	100	3 hours

Continuous Internal Evaluation Pattern:

Attendance : 10 marks

Continuous Assessment Test (2 numbers) : 25 marks

Assignment/Quiz/Course project : 15 marks

End Semester Examination Pattern: There will be two parts; Part A and Part B. Part A contain 10 questions with 2 questions from each module, having 3 marks for each question. Students should answer all questions. Part B contains 2 questions from each module of which student should answer any one. Each question can have maximum 2 sub-divisions and carry 14 marks.

Course Level Assessment Questions

Course Outcome 1 (CO1):

1. Discuss how saturation affects the accuracy of C.T.s. (K2)
2. Why I.D.M.T. relays are widely used for over current protection (K2))
3. Develop a criteria for the selection off distance relays.(K3)

Course Outcome 2 (CO2)

1. In what way distance protection is superior to over current protection for the protection of transmission lines.(K2)
2. Discuss the working principle of frame leakage protection.(K2)
3. Explain the differential scheme for bus zone protection.(K1)

Course Outcome 3(CO3):

1. Explain the principle of operation of numerical relays. (K1)
2. What is the function of the sample and hold circuit.(K2)
3. Explain the sliding window concept.(K2)

Course Outcome 4 (CO4):

1. Explain the concept of Finite Impulse Response filters,(K2)
2. Explain sinusoidal wave based algorithms. (K1)
3. Explain Least squares based algorithm. (K1)

Course Outcome 5 (CO5):

ELECTRICAL AND ELECTRONICS

1. Compare the different decision making schemes in protective relays.(K2)
2. Explain the concept of synchronized sampling. (K2)
3. What are the basic components of a phasor measurement unit.(K1)

Model Question Paper

QP CODE: _____

PAGES:4

Reg.No: _____

Name: _____

APJ ABDUL KALAM TECHNOLOGICAL UNIVERSITY
SEVENTH SEMESTER B.TECH DEGREE EXAMINATION,
MONTH & YEAR

Course Code: EET473

Course Name : DIGITAL PROTECTION OF POWER SYSTEMS

Max. Marks: 100
Hours

Duration: 3

PART A (3 x 10 = 30 Marks)

Answer all Questions. Each question carries 3 Marks

1. Explain the basic principle and characteristics of impedance relays.
2. Explain current setting and time setting.
3. Explain the effect of power swings on the performance of distance relays.
4. What are the features of directional protection schemes for distribution system.
5. Give a comparison of numerical relays with static relays.
6. What are the basic components of numerical relays. Explain
7. Why digital filtering is required in a digital relay. Explain.
8. What are the useful properties of finite impulse filter.
9. What are the advantages of adaptive relaying
10. Give the definition of wide-area protection

PART B (14 x 5 = 70 Marks) ELECTRICAL AND ELECTRONICS

Answer any one full question from each module. Each question carries 14 Marks

Module 1

- 11.a) Explain the time current characteristics of inverse, very inverse and extremely inverse over current relays. Discuss their area of applications 7
- b) What are the requirements of C.T. s used for protection. 7
- 12.a) Explain the types of construction used for P.T.s. 7
- b) Explain the basic principle and characteristics of reactance and mho relays. 7

Module 2

- 13.a) With the help of a schematic diagram explain the carrier current protection scheme. 7
- b) With the help of a neat diagram explain the working of harmonic restraint relay. 7
- 14.a) Explain the Phase comparison line protection scheme. 7
- b) Explain the loss of excitation protection for a generator. 7

Module 3

- 15.a) With the help of a block diagram explain the basic components of a digital relay. 8
- b) Explain the communication in protective relays (IEC 61850) 6
- 16.a) Briefly explain the information handling with substation automation system. 7
- b) Explain the signal conditioning subsystem in numerical relays. 7

Module 4

- 17.a) Explain the full cycle window algorithm. 8
- b) Give a comparison between infinite impulse filter and finite impulse filter. 6
- 18.a) Give the basic formulation of sample and first derivative method in sinusoidal wave based algorithm. 8
- b) Explain how the impedance to the fault is found by using Least square method. 6

Module 5

- 19.a) Explain the methods of deterministic decision making and decision making with multiple criteria in protective relays. 8
- b) Explain the architectures of wide-area protection 6
- 20.a) Explain the concept of Adaptive relaying and its applications. 8
- b) Explain the Adaptive Differential protective scheme. 6

Syllabus

Module 1 (8 hours)

Introduction: Need for protective systems, Zones of protection, Current transformers and voltage transformers (Electromagnetic and Capacitive voltage transformers), Principle of operation of magneto optic CT/ PT, effect on relaying philosophy.

Relays: Over current relays - time-current characteristics of over current relays: definite time over current relays, inverse Definite Minimum time - directional over current relays, current setting and time setting - Numerical Problems - Differential relays: Operating and restraining characteristics, types of differential relays, Distance relays: impedance relays, reactance relays, mho relays, quadrilateral relays, elliptical relays (basic principles and characteristics only).

Module 2 (8 hours)

Protection of Transmission Line Systems: Schemes of distance protection, Differential line protection, Phase comparison line protection, Use of line carrier and communication links, Effect of power swings on the performance of distance relays.

Protection of Bus-bar, Transformer and Generator & Motor Systems: Types of faults, differential protection: High impedance and low impedance differential protection schemes, harmonic restraint relay, Restricted Earth Fault Protection, frame leakage protection, stator and rotor protection against various types of faults.

Pilot relaying schemes: Pilot wire protection, carrier current protection (Basic Principles and schematic).

Protection Scheme for Distribution Systems: Protection criteria for distribution system, Features of directional and non-directional protection schemes for distribution system, Fundamentals of travelling wave protection scheme.

Module 3 (8 hours)

Introduction to Digital (Numerical) Relays- Basic Components of numerical Relays with block diagram, Processing Unit, Human machine Interface, Principle of operation- Comparison of numerical relays with electromechanical and static relays, Advantages of numerical relays - communication in protective relays (IEC 61850), Information handling with substation automation system (SAS)

Signal Conditioning Subsystems: Surge Protection Circuits, Anti-aliasing filter, Conversion Subsystem, The Sampling Theorem, aliasing, Sample and Hold Circuit, Concept of analog to digital and digital to analog conversion, Idea of sliding window concept, Fourier, Discrete and fast Fourier transforms

Module 4 (6 hours)

Signal processing techniques: Sinusoidal wave based algorithms, Fourier Analysis based algorithms (half cycle and full cycle), Least squares based algorithm.

Digital filters – Fundamentals of Infinite Impulse Response Filters, Finite Impulse Response filters, Filters with sine and cosine windows

Module 5 (6 hours)

Decision making in Protective Relays – Deterministic decision making, Statistical Hypothesis testing, Decision making with multiple criteria, Adaptive decision schemes.

Wide Area Protection and Measurement: Phasor Measurement Units, concept of synchronized sampling, Definition of wide-area protection, Architectures of wide-area protection, concept of Adaptive relaying, advantages of adaptive relaying and its application, Adaptive Differential protective scheme.

Assignment - Simulation of protection schemes using SIMULINK

Text/References Books

1. A. T. Johns and S. K. Salman, "Digital Protection for Power Systems," Peter Peregrinus Ltd, UK, 1995.
2. Waldemar Rebizant, Digital Signal Processing in Power System Protection and Control –Springer Publication
3. J. L. Blackburn, "Applied Protective Relaying," Westinghouse Electric Corporation, New York, 1982.
4. A. G. Phadke and J. S. Thorp, "Computer Relaying for Power Systems," Research study press Ltd, John Wiley & Sons, Taunton, UK, 1988.
5. S.P Patra, S.K Bl,lsu and S. Choudhary, "Power System Protection", Oxford IBH Pub.
6. S. Ravindernath and M. Chander, "Power System Protection and Switchgear", Wiley Eastern Ltd.
7. Badri Ram and Vishwakarma, Power System Protection and Switchgear, A McGraw Hill.
8. Digital Signal Processing in Power System Protection and Control by Waldemar Rebizant, Janusz Szafran ,Andrzej Wiszniewski - Springer publication

Course Contents and Lecture Schedule:

No	Topic	No. of Lectures
1	Introduction to protective relays (8 hours)	
1.1	Introduction: Need for protective systems, Zones of protection, Current transformers and voltage transformers (Electromagnetic and Capacitive voltage transformers), Principle of operation of magneto optic CT/ PT, effect on relaying philosophy.	2
1.2	Relays: Over current relays-time-current characteristics of over current	2

	relays: definite time over current relays, inverse Definite Minimum time -directional over current relays, current setting and time setting- Numerical Problems	
1.3	Differential relays: Operating and restraining characteristics, types of differential relays,	1
1.4	Distance relays: impedance relays, reactance relays, mho relays, quadrilateral relays, elliptical relays (basic principles and characteristics only).	3
2	Protection of Transmission, Distribution, Bus-bar, Transformer, Generator & Motor Systems (8 hours)	
2.1	Protection of Transmission Line Systems: Schemes of distance protection, Differential line protection, Phase comparison line protection, Use of line carrier and communication links, Effect of power swings on the performance of distance relays.	2
2.2	Protection of Bus-bar, Transformer and Generator & Motor Systems: Types of faults, differential protection: High impedance and low impedance differential protection schemes, harmonic restraint relay, Restricted Earth Fault Protection, frame leakage protection, stator and rotor protection against various types of faults.	3
2.3	Pilot relaying schemes: Pilot wire protection, carrier current protection (Basic Principles and schematic) .	1
2.4	Protection Scheme for Distribution Systems: Protection criteria for distribution system, Features of directional and non-directional protection schemes for distribution system, Fundamentals of travelling wave protection scheme.	2
3	Introduction to Digital (Numerical) Relays (8 hours)	
3.1	Basic Components of numerical Relays with block diagram, Processing Unit, Human machine Interface, Principle of operation- Comparison of numerical relays with electromechanical and static relays, Advantages of numerical relays	3
3.2	Communication in protective relays (IEC 61850), Information handling with substation automation system (SAS)	1
3.3	Signal Conditioning Subsystems: Surge Protection Circuits, Anti-aliasing filter, Conversion Subsystem, The Sampling Theorem, aliasing, Sample and Hold Circuit, Concept of analog to digital and digital to analog conversion	3
3.4	Idea of sliding window concept, Fourier, Discrete and fast Fourier transforms	1

4	Signal processing techniques (6 hours)	
4.1	Signal processing techniques: Sinusoidal wave based algorithms, Fourier Analysis based algorithms (half cycle and full cycle), Least squares based algorithm	3
4.2	Digital filters – Fundamentals of Infinite Impulse Response Filters, Finite Impulse Response filters, Filters with sine and cosine windows	3
5	Decision making in Protective Relays (6 hours)	
5.1	Decision making in Protective Relays – Deterministic decision making, Statistical Hypothesis testing, Decision making with multiple criteria, Adaptive decision schemes.	2
5.2	Wide Area Protection and Measurement: Phasor Measurement Units, concept of synchronized sampling, Definition of wide-area protection, Architectures of wide-area protection	2
5.3	concept of Adaptive relaying, advantages of adaptive relaying and its application, Adaptive Differential protective scheme.	2

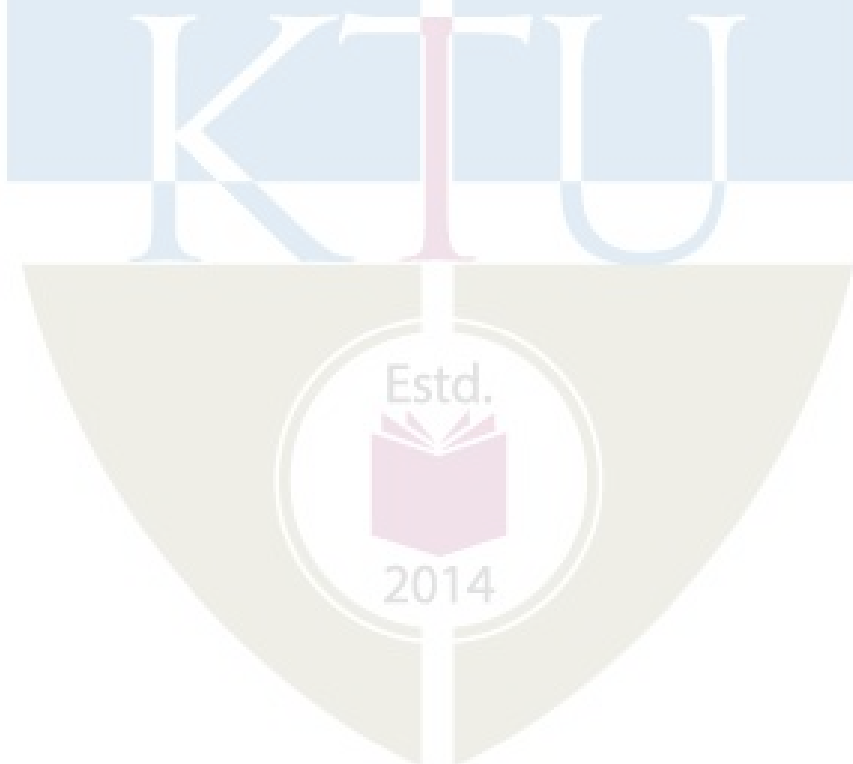

CODE	COURSE NAME	CATEGORY	L	T	P	CREDIT
EET415	CONTROL SYSTEMS ENGINEERING	OEC	2	1	0	3

Preamble: Control Engineering is not limited to any engineering discipline, but is equally applicable to mechanical, chemical, electrical, aeronautical engineering. The most characteristic quality of control engineering is the opportunity to control machines, industrial and economic process for the benefit of society. This course aims to provide a strong foundation on classical control theory. In this course modelling, time domain analysis, frequency domain analysis and stability analysis of linear systems based on transfer function approach will be discussed.

Prerequisite: Knowledge of Laplace transforms.

Course Outcomes: After the completion of the course the student will be able to:

CO 1	Identify the elements of control system.
CO 2	Develop transfer function models of systems.
CO 3	Analyse the relation between pole locations with the transient response of first and second order systems.
CO 4	Determine the stability of LTI systems.
CO 5	Apply the concept of Root locus to assess the performance of linear systems.
CO 6	Determine the frequency domain specifications from Bode plot, Polar plot and Nyquist plot.

Mapping of course outcomes with program outcomes

	PO 1	PO 2	PO 3	PO 4	PO 5	PO 6	PO 7	PO 8	PO 9	PO 10	PO 11	PO 12
CO 1	3	2	-	-	-	-	-	-	-	-	-	1
CO 2	3	2	-	-	-	-	-	-	-	-	-	1
CO 3	3	2	-	-	2	-	-	-	-	-	-	1
CO 4	3	2	-	-	-	-	-	-	-	-	-	1
CO 5	3	2	-	-	2	-	-	-	-	-	-	1
CO 6	3	2	-	-	2	-	-	-	-	-	-	1

Assessment Pattern

Bloom's Category	Continuous Assessment Tests		End Semester Examination
	1	2	
Remember	10	10	20
Understand	20	20	40
Apply	20	20	40
Analyse			
Evaluate			
Create			

Mark distribution

Total Marks	CIE	ESE	ESE Duration
150	50	100	3 hours

Continuous Internal Evaluation Pattern:

Attendance	: 10 marks
Continuous Assessment Test (2 numbers)	: 25 marks
Assignment/Quiz/Course project	: 15 marks

End Semester Examination Pattern: There will be two parts; Part A and Part B. Part A contain 10 questions with 2 questions from each module, having 3 marks for each question. Students should answer all questions. Part B contains 2 questions from each module of which student should answer any one. Each question can have maximum 2 sub-divisions and carry 14 marks.

Course Level Assessment Questions:**Course Outcome 1 (CO1)**

1. Explain with an example how does the feedback element affects the performance of a closed loop system. (K3, PO1, PO2 and PO12)
2. What is the function of controller and sensor in a closed loop system? (K2, PO1)
3. What are the modifications required to convert an open loop system to a closed loop system? (K1, PO1, PO12)

Course Outcome 2 (CO2)

1. Problems related to derivation of transfer function of mechanical systems. (K3, PO1 and PO12)
2. Define transfer function and derive the transfer function of an RC network. (K3, PO1, PO2 and PO12)
3. Write short notes on Force- voltage and Force – current analogy? (K1, PO1, PO12)

Course Outcome 3 (CO3)

1. What is the effect of location of roots on S-plane on the transient response of a system? (K1, PO1, PO12)
2. What is the change in transient response of a second order system due to the addition of poles? Illustrate with an example. (K1, PO1, PO2, PO12)
3. What is the significance of settling time in control system? (K1, PO1, PO12)

Course Outcome 4 (CO4)

1. Problems related to application of Routh's stability criterion for analysing the stability of a given system. (K3, PO1, PO2, PO12)
2. Plot the impulse response of a second order system for different location of poles on S-plane. (K3, PO1, PO2, PO12)

3. How can we relate asymptotic stability to location of roots of characteristic equation?
K2, PO1, PO2, PO12)

Course Outcome 5 (CO5)

1. Determine the value of K such that the closed loop system with $G(s)H(s) = \frac{K}{s(s+1)(s+4)}$ is oscillatory, using Root locus. (K3, PO1, PO2, PO12)
2. Construct the Root locus for the closed loop system with $G(s)H(s) = \frac{K}{s(s^2+2s+2)}$ and determine the value of K to achieve a damping factor of 0.5. (K3, PO1, PO2, PO12)
3. Problems on root locus for systems with positive feedback. (K3, PO1, PO2, PO12)

Course Outcome 6 (CO6)

1. Problems related to assess the stability of the given system using Bode plot. (K3, PO1, PO2, PO3, PO12)
2. Problems related to Polar plot. (K3, PO1, PO2, PO12)
3. Explain Nyquist stability criterion. (K2, PO1, PO2, PO12)

Model Question Paper

PAGES: 2

QPCODE:

Reg. No: _____

Name: _____

APJ ABDUL KALAM TECHNOLOGICAL UNIVERSITY

SEVENTH SEMESTER B.TECH DEGREE EXAMINATION

MONTH & YEAR

Course Code: **EET415**

Course Name: **CONTROL SYSTEMS ENGINEERING**

Max. Marks: 100

Duration: 3 Hours

PART A

Answer all Questions. Each question carries 3 Marks

1. Write short notes on Force- voltage and Force – current analogy?
2. Explain Mason's gain formula?
3. Define damping ratio.
4. Derive and sketch the time response of a first order system.
5. What are dynamic error coefficients? What are their merits?
6. Define BIBO Stability. What is the requirement of BIBO Stability?
7. How to determine break away and break in point in root locus plot?
8. What is the significance of dominant pole?
9. Write a short note on the correlation between time and frequency response
10. Explain Nyquist stability criterion

PART B ELECTRICAL AND ELECTRONICS

Answer any one full question from each module. Each question carries 14 Marks

Module 1

9. a. Derive the transfer function for the mechanical system shown in figure. 10

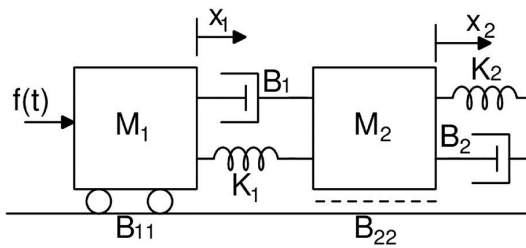

b. Distinguish between open loop system and closed loop system 4

10. a. Reduce the block diagram shown in figure 10

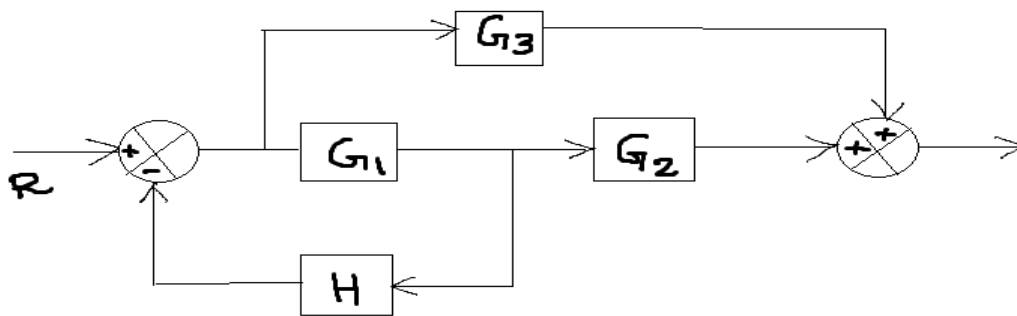

b. Define transfer function and derive the transfer function of an RC network 4

Module 2

11 a. Sketch the time response of a general second order underdamped system and explain the specifications 6

b. The damping ratio of a system is 0.6 and the natural frequency of oscillation is 8 rad/sec. Determine the rise time, peak overshoot and peak time 8

12a. Distinguish between type and order of a system 5

b. The open loop transfer function of a unity feedback system is

$$G(s) = 20/s(s + 10)$$

What is the nature of response of closed loop system for unit step input? 9

Module 3

13 a. Plot the impulse response of a second order system for different location of poles on S-plane. 9

b. What is the effect of location of roots on S-plane on the transient response of a system? 5

14 a. A unity feedback system has a open loop transfer function of 7

$$G(s) = 10/(s + 1)(s + 2)$$

Determine steady state error for unit step input

b. Using Routh criterion determine the value of K for which the unity feedback closed

loop system with $G(s) = \frac{K}{s(s^2 + 20s + 8)}$ is stable. 7

Module 4

- 15 a. What is the relation between stability and coefficient of characteristic polynomial? 2
 b. Explain the methods to find the crossing points of Root locus in imaginary axis. 4
 c. Sketch the root locus for the unity feedback system whose open loop transfer function is given by: 8

$$G(s) = \frac{K}{s(s + 4)(s^2 + 4s + 20)}$$

16. Draw the root locus for a unity feedback system having forward path transfer function,

$$G(s) = \frac{K}{s(s+1)(s+5)} \quad 8$$

- (a) Determine value of K which gives continuous oscillations and the frequency of oscillation.
 (b) Determine the value of K corresponding to a dominant closed loop pole with damping ratio 0.7 6

Module 5

17. Consider a unity feedback system having an open loop transfer function

$$G(s) = k/s(1 + 0.2s)(1 + 0.05s)$$

- (a) Sketch the polar plot 8
 (b) Determine the value of K so that
 (i) Gain margin is 18 db
 (ii) Phase margin is 60° 6

18. (a) The open loop transfer function of a system is given by

$$G(s) = k/s(1 + 0.2s)(1 + 0.5s)$$

Sketch the Bode plot 8

- (b) From the Bode plot determine the value of K so that

- (i) Gain margin of the system is 6 db
- (ii) Phase margin of the system is 25°

Syllabus

Module 1

Feedback Control Systems (10 hours)

Open loop-and closed loop control systems: Transfer function of LTI systems- Mechanical and Electromechanical systems – Force voltage and force current analogy - block diagram representation - block diagram reduction - signal flow graph - Mason's gain formula - characteristic equation..

Module 2

Performance Analysis of Control Systems (5 hours)

Time domain analysis of control systems: Transient and steady state responses - time domain specifications - first and second order systems - step responses of first and second order systems.

Module 3

Error Analysis and Stability (6 hours)

Error analysis: Steady state error analysis and error constants -Dynamic error coefficients.

Stability Analysis: Concept of BIBO stability and Asymptotic stability- Time response for various pole locations- stability of feedback systems - Routh's stability criterion-

Module 4

Root Locus Technique (6 hours)

Root locus technique: Construction of Root locus- stability analysis- effect of addition of poles and zeroes.

Module 5

Frequency Domain Analysis (9 hours)

Frequency domain specifications- correlation between time domain and frequency domain responses.

Polar plot: Concepts of gain margin and phase margin- stability analysis

Bode Plot: Construction- Concepts of gain margin and phase margin.

Nyquist stability criterion (criterion only)

Text books

1. Nagarath I. J. and Gopal M., Control System Engineering, 5/e, New Age Publishers
2. Ogata K, Modern Control Engineering, 5/e, Prentice Hall of India.
3. Nise N. S, Control Systems Engineering, 6/e, Wiley Eastern
4. Dorf R. C. and Bishop R. H, Modern Control Systems, 12/e, Pearson Education

Reference Books

1. Kuo B. C, Automatic Control Systems, 7/e, Prentice Hall of India
2. Desai M. D., Control System Components, Prentice Hall of India, 2008
3. Gopal M., Control Systems Principles and Design, 4/e, Tata McGraw Hill.
4. Imthias Ahamed T. P, Control Systems, Phasor Books, 2016

Course Contents and Lecture Schedule:

Module	Topic coverage	No. of Lectures
1	Feedback Control Systems (10 hours)	
1.1	Terminology and basic structure of Open loop and Closed loop control systems- Examples of Automatic control systems (block diagram representations only).	2
1.2	Transfer function approach to feed back control systems- Mechanical and Electromechanical systems	2
1.3	Force –voltage , force –current analogy.	2
1.4	Block Diagram Reduction Techniques.	2
1.5	Signal flow graph- Mason's gain formula, Characteristic Equation.	2
2	Performance Analysis of Control Systems (5 hours)	
2.1	Time domain analysis of control systems: Transient and steady state responses- Impulse and Step responses of first and second order systems Time domain specifications.	4
2.2	Time domain specifications.	1
3	Error analysis and Stability(6 hours)	
3.1	Error analysis: Steady state error analysis - static error coefficient of Type 0, 1, 2 systems. Dynamic error coefficients.	2
3.2	Stability Analysis: Concept of stability-BIBO stability and Asymptotic stability- Time response for various pole locations- stability of feedback systems.	2
3.3	Application of Routh's stability criterion to control system analysis- Relative stability.	2
4	Root Locus Technique (6 hours)	
4.1	Root locus technique: General rules for constructing Root loci – stability from root loci -	5
4.2	Effect of addition of poles and zeros on Root locus	1

5	Frequency domain analysis (9 hours) ELECTRICAL AND ELECTRONICS	
5.1	Frequency domain specifications- correlation between time domain and frequency domain responses.	2
5.2	Polar plot: Concepts of gain margin and phase margin- stability analysis.	2
5.3	Bode Plot: Construction of Bode plots- gain margin and phase margin- Stability analysis based on Bode plot .	4
5.4	Nyquist stability criterion	1

APJ ABDUL KALAM
TECHNOLOGICAL
UNIVERSITY

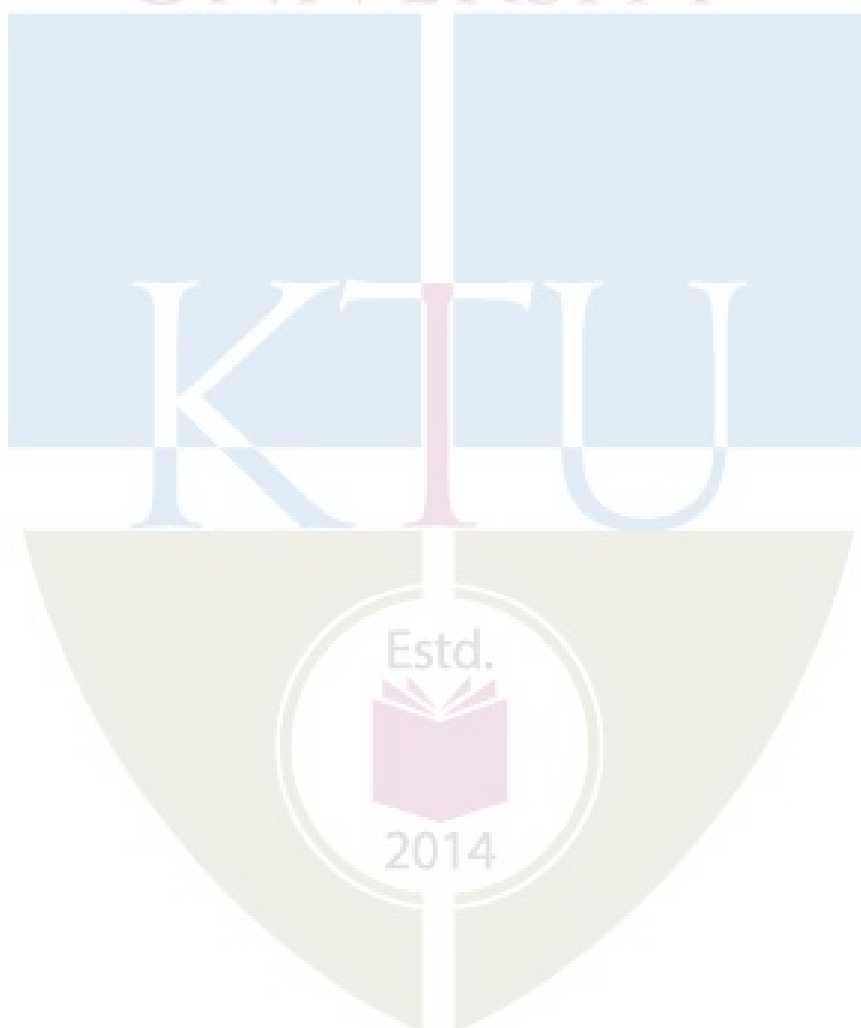

CODE	COURSE NAME	CATEGORY	L	T	P	CREDIT
EET425	INTRODUCTION TO POWER PROCESSING	OEC	2	1	0	3

Preamble: The recent advances in power electronics has resulted in the development of various industrial and household devices/equipment that employ power processing. It is important for engineering professionals to understand the fundamental principles behind such devices/systems. This course provides an overview of various essential elements of power electronics used for power processing, and their principle of operation. Power electronics deals with the processing and control of ‘raw’ electrical power from an electrical source. The power levels handled can vary from a few watts to several hundreds of megawatts. It is an enabling technology with a very wide range of applications. The course contents enable the students to understand the principles of power electronics and provide an introduction to various applications such as industrial drives, renewable energy, power supplies and electrical /hybrid vehicles.

Prerequisite: EST 130 Basics of Electrical and Electronics Engineering

Course Outcomes : After the completion of the course the student will be able to:

CO 1	Explain different elements of power electronics.
CO 2	Explain various power electronic converters.
CO 3	Describe the basic principles of ac and dc motor drives.
CO 4	Describe the structure of power processing systems in power supplies, renewable energy conversion and EVs.

Mapping of course outcomes with program outcomes

	PO 1	PO 2	PO 3	PO 4	PO 5	PO 6	PO 7	PO 8	PO 9	PO 10	PO 11	PO 12
CO 1	2											
CO 2	2											
CO 3	2								2			
CO 4	2						2		2			

Assessment Pattern

Bloom's Category	Continuous Assessment Tests		End Semester Examination
	1	2	
Remember	20	20	40
Understand	30	30	60
Apply			
Analyse			
Evaluate			
Create			

Mark distribution

Total Marks	CIE	ESE	ESE Duration
150	50	100	3 hours

Continuous Internal Evaluation Pattern:

Attendance	: 10 marks
Continuous Assessment Test (2 numbers)	: 25 marks
Assignment/Quiz/Course project	: 15 marks

End Semester Examination Pattern: There will be two parts; Part A and Part B. Part A contain 10 questions with 2 questions from each module, having 3 marks for each question. Students should answer all questions. Part B contains 2 questions from each module of which student should answer any one. Each question can have a maximum of 2 subdivisions and carry 14 marks.

Course Level Assessment Questions**Course Outcome 1 (CO1):**

1. Explain the principle of operation of MOSFET. (K2, PO1)
2. What is the difference between thyristors and controllable switches? (K1, PO1)
3. Why are IGBTs becoming popular in their applications to controlled converters ?
4. Enumerate some applications of IGBTs. (K1, PO1)
5. What are the applications of power electronic systems? (K1, PO1)

Course Outcome 2 (CO2)

1. With a neat circuit and waveforms, explain the working of a boost DC-DC converter.(K2, PO1)
2. With the help of waveform explain sinusoidal pulse width modulation used in single phase inverter. (K2, PO1)
3. Explain the working of a single-phase half bridge square wave inverter with pure R load. Draw the output voltage and output current waveforms.(K2, PO1)
4. Illustrate how a thyristor based 1-phase fully controlled rectifier can be used to convert ac into variable dc. Draw the waveforms of output voltage and output current for both R and RL load at $\alpha= 30$ degree.(K2, PO1)

Course Outcome 3(CO3):

1. Give the classification of DC motors based on their field winding excitation with neat diagrams.(K2, PO9)
2. What is meant by armature reaction? What are its effects on main field flux? (K1, PO9)
3. Explain V/F control of induction motor drives. (K2, PO9)
4. Explain why we use starters for starting a DC motor. (K2, PO9)

Course Outcome 4 (CO4):

1. Explain a standalone solar PV system with a block diagram. (K2, PO7, PO9)
2. Explain the components of a linear power supply. (K2, PO7, PO9)
3. Distinguish between HEV and PHEV. (K2, PO7, PO9)
4. Explain the powertrain in an EV. (K2, PO7, PO9)

Model Question Paper**QP CODE:****PAGES:****Reg. No:** _____**Name:** _____

APJ ABDUL KALAM TECHNOLOGICAL UNIVERSITY
SEVENTH SEMESTER B.TECH DEGREE EXAMINATION,
MONTH & YEAR Course Code: EET425
Course Name: INTRODUCTION TO POWER PROCESSING

Max. Marks: 100**Duration: 3 Hours****PART A (3 x 10 = 30 Marks)****Answer all Questions. Each question carries 3 Marks.**

1. Explain the principle of operation of SCR.
2. What are wide bandgap devices? What are its advantages?
3. With a neat circuit explain the working of single phase fully controlled SCR based bridge rectifiers with R load.
4. With neat circuit, explain the working of a boost DC-DC converter
5. Differentiate between voltage source inverter and current source inverter.
6. With the help of waveform explain sinusoidal pulse width modulation used in single phase inverter.
7. What is meant by armature reaction?
8. Explain why we use starters for starting a DC motor.
9. What is the difference between on grid and off grid Solar PV installations?
10. Give three advantages of electric vehicles over the conventional IC engine driven vehicles.

PART B (14 x 5 = 70 Marks)

Answer any one full question from each module. Each question carries 14 Marks

Module 1

11. (a) What are the advantages, disadvantages and applications of power electronic systems? (10)
- (b) Compare a diode and a thyristor. (4)
12. (a) Describe the working of IGBT. How does latch-up occur in an IGBT? Why are IGBTs becoming popular in their applications to controlled converters? Enumerate some applications of IGBTs. (10)
- (b) With a neat block diagram, explain a typical power electronic system. (4)

Module 2

13. (a) Illustrate how a thyristor based 1-phase fully controlled rectifier can be used to convert ac into variable dc. Draw the waveforms of output voltage and output current for RL load at $\alpha = 30$ degree. (10)
- (b) Discuss the significance of a freewheeling diode. (4)
- 14 (a) Explain with a circuit diagram and necessary waveforms, the working of a buck regulator for continuous current mode. (10)
- (b) Explain the phenomenon of inductive kick. (4)

Module 3

- 15 (a) Explain the working of a single-phase half bridge square wave inverter with pure R load. Draw the output voltage and output current waveforms. (10)
- (b) What is its main drawback? Explain how this drawback is overcome. (4)
- 16 (a) What is an ac voltage controller? List some of its industrial applications. Enumerate its merits and demerits. (7)
- (b) Describe the operation of a single phase ac voltage controller with R load with necessary waveforms. (7)

Module 4

17. (a) With a neat schematic explain the components of an electric drive system (7)
- (b) Explain the four-quadrant operation of a dc motor (7)
- 18 (a) List various control strategies used in induction motor drives (4)
- (b) Explain V/F control of induction motor drives. (10)

Module 5

19. (a) Explain the operation of a grid connected solar PV system with a neat block schematic (7)
 (b) Explain the components of a linear power supply. (7)
20. (a) Distinguish between HEV and PHEV (4)
 (b) Explain different energy storage systems used in Electric Vehicles (10)

Syllabus**Module 1**

Introduction to power processing, elements of power electronics, power semiconductor devices. Uncontrolled, Semiconrolled and Fully controlled switches: Diode, SCR, MOSFETs and IGBTs- principle of operation. Advantages of wide bandgap devices-SiC, GaN.

Module 2

Basic power conversion circuits- converter circuits: Controlled rectifiers: Single- phase fully controlled SCR based bridge rectifier with R and RL load (continuous mode only). Principle of operation and waveforms (No analysis required).

DC-DC Converters (Non-isolated) : Buck, Boost and Buck-Boost converter. Circuit operation, voltage gain and waveforms in continuous conduction mode (No analysis required).

Module 3

Single phase half and full bridge Inverter: Square-wave operation with R load. Types of PWM - single pulse, multiple pulse and sinusoidal PWM. Total Harmonic Distortion(THD).

Three phase voltage source inverter with R load- 120 and 180 degree conduction mode - waveforms

Single phase AC voltage controller with R load- waveforms.

Module 4

Applications: 1. *Motor drives*:

Introduction to electric motor drive- Block diagram

4-quadrant operation of a separately excited dc motor (circuit diagram and waveforms only).

Induction motor drives: Principle of operation- v/f control

Module 5

Applications 2: *Renewable energy*- solar PV installations-off grid and on grid systems: Principle of operation - Block diagram.

Applications 3: *Power supplies* - Principle of operation of linear and switched mode power supply- requirements of power supplies- Isolation, protection and regulation.

Applications 4: *Electric vehicles* - Introduction to HEV, PHEV and BEV-Block schematic of power train. Introduction to energy storage in EVs - Li Batteries, Hydrogen Fuel Cell.

Text/Reference Books

1. Ned Mohan, Tore m Undeland, William P Robbins, “Power electronics converters applications and design”, John Wiley and Sons, 2003.
2. Muhammad H. Rashid, Power Electronics Circuits, Devices and Applications, Pearson Education, 2009.
3. P.S. Bimbhra, Power Electronics, Khanna Publishers, New Delhi, 2012.
4. Dubey G. K. “Fundamentals of Electrical drives” Narosa Publishing House, 1995.
5. Andrzej M. Trzynadlowski, Introduction to Modern Power Electronics, 3rd Edition, Wiley, 2015.
6. Iqbal Hussein, Electric and Hybrid Vehicles: Design Fundamentals, CRC Press, 2003.
7. Abbasi S. A. and N. Abbasi, Renewable Energy Sources and Their Environmental Impact, Prentice Hall of India, 2001.
8. Sawhney G. S., Non-Conventional Energy Resources, PHI Learning, 2012.
9. Non conventional energy sources, NPTEL lecture by Prof.Prathap Haridoss, IIT Chennai.
10. Abad, Gonzalo, ed. Power electronics and electric drives for traction applications. USA: Wiley, 2017.

Estd.



2014

No.	Topic	No. of Lectures
1	Introduction to power processing (6 hours)	
1.1	Introduction to power electronics and its objectives, Advantages, disadvantages, applications, typical power electronic system	1
1.2	Elements of power electronics, power semiconductor devices.	1
1.3	Symbol and principle of operation of diode and SCR	1
1.4	Symbol and principle of operation of MOSFET	1
1.5	Symbol and principle of operation of IGBT	1
1.6	Advantages of wide bandgap devices- SiC, GaN	1
2	Basic power conversion circuits (6 hours)	
2.1	Converter circuits	1
2.2	Single- phase fully controlled SCR based bridge rectifier with R (continuous mode only), Principle of operation and waveforms (No analysis required)	1
2.3	Single- phase fully controlled SCR based bridge rectifier with RL load (continuous mode only), Principle of operation and waveforms (No analysis required)	1
2.4	DC-DC Converters (Non-isolated) : Buck converter. Circuit operation, voltage gain and waveforms in continuous conduction mode (No analysis required).	1
2.5	Boost converter. Circuit operation, voltage gain and waveforms in continuous conduction mode (No analysis required).	1
2.6	Buck-Boost converter. Circuit operation, voltage gain and waveforms in continuous conduction mode (No analysis required).	1
3	Inverter circuits, AC voltage controllers (6 hours)	
3.1	Voltage source inverters	1
3.2	Single phase half and full bridge Inverter-Square-wave operation	1

	with R load	
3.3	Types of PWM - single pulse, multiple pulse and sinusoidal PWM Total Harmonic Distortion (THD)	1
3.4	Three phase voltage source inverter with R load- 120 degree conduction mode - waveforms	1
3.5	Three phase voltage source inverter with R load- 180 degree conduction mode - waveforms	1
3.6	Single phase AC voltage controller with R load- waveforms.	1
4	Applications of power processing in Drives (9 hours)	
4.1	Introduction to electric drives, components of electric drive, advantages of electric drives.	1
4.2	DC motor – principle of operation – back emf – necessity of motor starter-classification,	2
4.3	Four quadrant operation of separately excited DC Motor	2
	Three phase induction motor-squirrel cage and slip ring induction motor, Working principle-synchronous speed, slip	2
4.4	Induction Motor Drives, V/F control	2
5	Applications of power processing in renewable energy generation, power supplies and EVs (5 hours)	
5.1	Solar PV installations-Off grid and On grid	1
5.2	Linear and Switch Mode Power Supplies, Functional Block Diagram and operation	2
5.3	Introduction to Electric Vehicle, Various Types, Types of Energy Storage	2

CODE	COURSE NAME	CATEGORY	L	T	P	CREDIT
EET435	RENEWABLE ENERGY SYSTEMS	OEC	2	1	0	3

Preamble: Objective of this course is to inculcate in students an awareness of new and renewable energy sources.

Prerequisite: Students who have taken EET383 MINOR are not eligible to take this course.

Course Outcomes: After the completion of the course the student will be able to

CO 1	Choose the appropriate energy source depending on the available resources.
CO 2	Explain the concepts of solar thermal and solar electric systems.
CO 3	Illustrate the operating principles of wind, and ocean energy conversion systems.
CO 4	Outline the features of biomass and small hydro energy resources
CO 5	Describe the concepts of fuel cell and hydrogen energy technologies

Mapping of course outcomes with program outcomes

	PO 1	PO 2	PO 3	PO 4	PO 5	PO 6	PO 7	PO 8	PO 9	PO 10	PO 11	PO 12
CO 1	2					1	2					
CO 2	3											
CO 3	3					1	1					
CO 4	3					1	1					
CO 5	3											

Assessment Pattern

Bloom's Category	Continuous Assessment Tests		End Semester Examination
	1	2	
Remember	25	25	50
Understand	20	20	40
Apply	5	5	10
Analyse			
Evaluate			
Create			

Mark distribution

Total Marks	CIE	ESE	ESE Duration
150	50	100	3 hours

Continuous Internal Evaluation Pattern:

Attendance	: 10 marks
Continuous Assessment Test (2 numbers)	: 25 marks
Assignment/Quiz/Course project	: 15 marks

End Semester Examination Pattern: There will be two parts; Part A and Part B. Part A contain 10 questions with 2 questions from each module, having 3 marks for each question. Students should answer all questions. Part B contains 2 questions from each module of which student should answer any one. Each question can have a maximum of 2 subdivisions and carry 14 marks.

Course Level Assessment Questions**Course Outcome 1 (CO1):**

1. Write short notes on the advantages and disadvantages of any three types of non conventional energy sources.(K1, PO1)
2. What are the points to be considered while constructing a house for energy efficiency? (K2, PO1, PO6, PO7)

Course Outcome 2 (CO2)

1. Explain construction of solar flat plate collector with a neat diagram. (K2, PO1)
2. Draw the block diagram of a solar thermal electric plant and explain its working. (K1, PO1)
3. Discuss the effect of temperature and insolation on the characteristics of solar cell. Draw the P-V characteristics of Solar cell under varying temperature and irradiation level. (K3, PO1)

Course Outcome 3 (CO3):

1. Derive the expression for power in the wind turbine. (K1, PO1, PO6, PO7)
2. Classify tidal power plants and brief explain any two of them. (K1, PO1, PO6, PO7)
3. With the help of a block diagram explain the working of a hybrid OTEC. (K2, PO1, PO6, PO7)

Course Outcome 4 (CO4):

1. What are the factors that affect biogas generation? (K1, PO1, PO6, PO7)
2. Compare the construction and performance of floating drum type and fixed dome type biogas plants with the help of neat sketches. (K2, PO1, PO6, PO7)
3. Discuss the selection criteria of turbines for a small hydro project. (K1, PO1, PO6, PO7)

Course Outcome 5 (CO5):

1. What is small hydro power? How is it classified? Obtain an expression for the power that can be generated from a small hydro power station. (K1, PO1)
2. Explain the hydrogen energy system with necessary diagram. (K2, PO1)
3. What do you mean by the conversion efficiency of a fuel cell? (K1, PO1)

Model Question Paper**Total Pages:2**

Reg No.: _____ Name: _____

APJ ABDUL KALAM TECHNOLOGICAL UNIVERSITY**SEVENTH SEMESTER B.TECH DEGREE EXAMINATION****Course Code: EET435****Course Name: RENEWABLE ENERGY SYSTEMS**

Max. Marks: 100

Duration: 3 Hours

PART A*Answer all questions, each carries 3 marks.*

- 1 Differentiate between flat plate collectors and solar concentrators.
- 2 Discuss advantages and limitations of conventional energy sources.
- 3 With the help of a block diagram explain the working of a hybrid OTEC.
- 4 List out the advantages and disadvantages of a tidal power plant.
- 5 Discuss the different types of wind turbine rotors used to extract wind power.
- 6 The Danish offshore wind farm has a name plate capacity of 209.3 MW. As of January 2017 it has produced 6416 GWh since its commissioning 7.3 years ago. Determine the capacity factor of above wind farm.
- 7 What are the factors that affect biogas generation
- 8 Discuss the process of biomass to ethanol conversion
- 9 What are the components of micro hydel power plant.
- 10 Enumerate the design and selection of different types of turbines used for small hydro plants

PART B

Answer any one full question from each module. Each question carries 14 marks

Module 1

- 9 a) With the aid of a neat diagram, explain the working of a central tower collector type solar thermal electric plant (9)
- b) Define (i) Open Circuit Voltage (ii) Short circuit Current (iii) Fill factor and (iv) Efficiency of the solar cell (5)
- 10 a) Compare the components and working of a standalone and grid connected PV system (5)
- b) How energy resources are classified. Compare conventional and non conventional sources of energy resources (9)

Module 2

- 11 What are the site selection criteria for OTEC? Draw the block diagram and explain the working of Anderson cycle based OTEC system. Explain how biofouling affects efficiency of energy conversion and how can it be minimised? (14)
- 12 Explain the principle of operation of a tidal power plant. How it is classified? Draw the layout of a double basin tidal power plant and label all the components. Explain the function of each component (14)

Module 3

- 13 a) Prove that the maximum wind turbine output can be achieved when $V_d = \frac{1}{3}V_u$ (10)
 $V_d = \frac{1}{3}V_u$, where V_d and V_u are down-stream and up-stream wind velocity respectively
- b) What is pitch control of wind turbine? Explain. (4)
- 14 a) Determine the power output of a wind turbine whose blades are 12m in diameter and when the wind speed is 6m/s, the air density is about 1.2kg/m³ and the maximum power coefficient of the wind turbine is 0.35. (5)
- b) Explain the parts, their function and working of a wind power plant. What are the site selection criteria of a wind power plant? (9)

Module 4

- 15 a) With a neat schematic diagram , explain the biomass gasification based electric power generation system (5)
- b) Explain the how urban waste is converted into useful energy (9)
- 16 a) Compare the construction and performance of floating drum type and fixed dome type biogas plants with the help of neat sketches (10)
- b) Explain the importance of biomass programme in India (4)

Module 5

- 15 a) Explain the operation of a phosphoric acid fuel cell with the help of a suitable diagram (7)
- b) What are the different methods used for the production and storage of hydrogen (7)
- 16 a) Draw the layout of a mini hydro project and explain its working (7)
- b) Describe the working and constructional features of PEM fuel cell (7)

Syllabus

Module 1

Introduction, Classification of Energy Resources- Conventional Energy Resources - Availability and their limitations- Non-Conventional Energy Resources – Classification, Advantages, Limitations; Comparison.

SOLAR THERMAL SYSTEMS- Principle of Conversion of Solar Radiation into Heat – Solar thermal collectors. – Flat plate collectors. Solar concentrators (parabolic trough, parabolic dish, Central Tower Collector).

SOLAR ELECTRIC SYSTEMS- Solar Thermal Electric Power Generation – Solar Photovoltaic – Solar Cell fundamentals - characteristics, classification, .construction. Solar PV Systems – stand-alone and grid connected- Applications .

Module 2

ENERGY FROM OCEAN- Ocean Thermal Energy Conversion (OTEC)- Principle of OTEC system- Open Cycle (Claude cycle), Closed Cycle (Anderson cycle) and Hybrid cycle. Site-selection criteria- Biofouling- Advantages & Limitations of OTEC.

TIDAL ENERGY – Principle of Tidal Power- Components of Tidal Power Plant (TPP)- Classification-single basin- double basin types –Limitations -Environmental impacts.

Module 3

WIND ENERGY- Introduction- Basic principles of Wind Energy Conversion Systems (WECS) wind speed measurement-Classification of WECS- types of rotors. wind power equation -Betz limit. Electrical Power Output and Capacity Factor of WECS- Advantages and Disadvantages of WECS -site selection criteria.

Module 4

BIOMASS ENERGY- Introduction- Biomass fuels-Biomass conversion technologies -Urban waste to Energy Conversion- Biomass Gasification- Biomass to Ethanol Production- Biogas production from waste biomass- factors affecting biogas generation-types of biogas plants – KVIC and Janata model-Biomass program in India.

Module 5

SMALL HYDRO POWER- Classification as micro, mini and small hydro projects - Basic concepts and types of turbines- selection considerations.

EMERGING TECHNOLOGIES: Fuel Cell-principle of operation –classification- conversion efficiency and losses - applications .Hydrogen energy -hydrogen production -electrolysis - thermo chemical methods -hydrogen storage and utilization.

Text Books

1. G. D. Rai, “ Non Conventional Energy Sources”, Khanna Publishers, 2010.
2. Rao S. and B. B. Parulekar, Energy Technology, Khanna Publishers, 1999

Reference Books

1. G.N. Tiwari: Solar Energy-Fundamentals, Design, Modelling and Applications, Narosa Publishers, 2002
2. Earnest J. and T. Wizelius, Wind Power Plants and Project Development, PHI Learning, 2011.
3. Sab S. L., Renewable and Novel Energy Sources, MI. Publications, 1995.
4. Sawhney G. S., Non-Conventional Energy Resources, PHI Learning, 2012.
5. Tiwari G. N., Solar Energy- Fundamentals, Design, Modelling and Applications, CRC Press, 2002.
6. A.A.M. Saigh (Ed): Solar Energy Engineering, Academic Press, 1977
7. Abbasi S. A. and N. Abbasi, Renewable Energy Sources and Their Environmental Impact, Prentice Hall of India, 2001..
8. Boyle G. (ed.), Renewable Energy - Power for Sustainable Future, Oxford University Press, 1996

9. Earnest J. and T. Wizelius, Wind Power Plants and Project Development, PHI Learning, 2011.
10. F. Kreith and J.F. Kreider: Principles of Solar Engineering, McGraw Hill, 197
11. F. Kreith and J.F. Kreider: Principles of Solar Engineering, McGraw Hill, 1978 62.
12. Khan B.H, Non Conventional Energy resources Tata McGraw Hill, 2009.

Course Contents and Lecture Schedule

No	Topic	No. of Lectures (35 hours)
1	INTRODUCTION (7 HOURS)	
1.1	Classification of Energy Resources- Conventional Energy - Resources - Availability and their limitations	1
1.2	Non-Conventional Energy Resources – Classification, Advantages, Limitations, Comparison.	1
1.3	SOLAR THERMAL SYSTEMS- Principle of Conversion of Solar Radiation into Heat – Solar thermal collectors.	1
1.4	Flat plate collectors. Solar concentrators (parabolic trough, parabolic dish, Central Tower Collector)	1
1.5	SOLAR ELECTRIC SYSTEMS- Solar Thermal Electric Power Generation	1
1.6	Solar Photovoltaic – Solar Cell fundamentals - characteristics, classification, construction.	1
1.7	Solar PV Systems – stand-alone and grid connected- Applications	1
2	ENERGY FROM OCEAN (7 hours)	
2.1	Ocean Thermal Energy Conversion (OTEC)- Principle of OTEC system-	1
2.2	Open Cycle (Claude cycle), Closed Cycle (Anderson cycle)	1
2.3	Hybrid cycle. Site-selection criteria	1
2.4	Biofouling- Advantages & Limitations of OTEC	1
2.5	TIDAL ENERGY – Principle of Tidal Power- Components of Tidal Power Plant (TPP)-	1
2.6	Classification-single basin- double basin types –Limitations and environmental impacts	2
3	WIND ENERGY (7 hours)	
3.1	Introduction- Basic principles of Wind Energy Conversion Systems (WECS)	1
3.2	Wind speed measurement	1

3.3	Classification of WECS- types of rotors	2
3.4	Wind power equation -Betz limit	1
3.5	Electrical Power Output and Capacity Factor of WECS	1
3.6	Advantages and Disadvantages of WECS -site selection criteria	1
4	BIOMASS ENERGY (6 hours)	
4.1	Urban waste to Energy Conversion	1
4.2	Biomass Gasification- Biomass to Ethanol Production	1
4.3	Biogas production from waste biomass	2
4.4	Types of biogas plants – KVIC and Janata model	1
4.5	Biomass program in India.	1
5	SMALL HYDRO POWER (8 hours)	
5.1	Classification as micro, mini and small hydro projects	1
5.2	Basic concepts and types of turbines- selection considerations.	2
5.3	EMERGING TECHNOLOGIES: Fuel Cell-principle of operation	1
5.4	Classification- conversion efficiency and losses - applications	1
5.5	Hydrogen energy -hydrogen production	1
5.6	Electrolysis -thermo chemical methods	1
5.7	Hydrogen storage and utilization.	1



CODE	COURSE NAME	CATEGORY	L	T	P	CREDIT
EET445	ELECTRIC VEHICLES	OEC	2	1	0	3

Preamble: This course introduces basic knowledge about electric vehicles. Basic knowledge about the drives used in EV and HEV, battery management system, energy sources and communication networks are also discussed.

Prerequisite: NIL.

Course Outcomes: After the completion of the course the student will be able to

CO 1	Explain the basic concept of electric and hybrid electric vehicle
CO 2	Choose proper energy storage systems for vehicle applications
CO 3	Identify various communication protocols and technologies used in vehicle networks

Mapping of course outcomes with program outcomes

	PO 1	PO 2	PO 3	PO 4	PO 5	PO 6	PO 7	PO 8	PO 9	PO 10	PO 11	PO 12
CO 1	2					1	1					1
CO 2	2					1	1					1
CO 3	2					1	1					1

Assessment Pattern

Bloom's Category	Continuous Assessment Tests		End Semester Examination
	1	2	
Remember	10	10	20
Understand	25	25	50
Apply	15	15	30
Analyse			
Evaluate			
Create			

Mark distribution

Total Marks	CIE	ESE	ESE Duration
150	50	100	3 hours

Continuous Internal Evaluation Pattern:

Attendance	: 10 marks
Continuous Assessment Test (2 numbers)	: 25 marks
Assignment/Quiz/Course project	: 15 marks

End Semester Examination Pattern: There will be two parts; Part A and Part B. Part A contain 10 questions with 2 questions from each module, having 3 marks for each question. Students should answer all questions. Part B contains 2 questions from each module of which student should answer any one. Each question can have maximum 2 sub-divisions and carry 14 marks.

Course Level Assessment Questions**Course Outcome 1 (CO1):**

1. List various vehicle performance indices. (K1, PO1, PO6, PO7)
2. List various hybrid electric vehicle topologies.(K1, PO1)
3. Highlight the importance of control of electric motor drives in electric and hybrid electric vehicle powertrains. (K2, PO1, PO6, PO7)

Course Outcome 2 (CO2)

1. State the different characteristics of the energy storage system used in electric and hybrid electric vehicles .(K2, PO1, PO6, PO7)
2. Describe how the battery size can be reduced in electric and hybrid electric vehicles. (K2, PO1, PO6, PO7)
3. Illustrate the different methods used for increasing the battery life in electric and hybrid electric vehicles. (K2, PO1, PO6, PO7)

Course Outcome 3 (CO3):

1. List the general objectives of energy management strategies employed in electric and hybrid electric vehicles. (K1, PO1, PO6, PO7)
2. Identify various communication protocols used in electric and hybrid electric vehicles. (K1, PO1, PO6)
3. Illustrate how fuel economy is maintained in hybrid electric vehicles. (K2, PO1, PO6, PO7)

Model Question Paper**QP CODE:**

PAGES: 3

Reg. No: _____

Name: _____

**APJ ABDUL KALAM TECHNOLOGICAL UNIVERSITY
SEVENTH SEMESTER B.TECH DEGREE EXAMINATION,
MONTH & YEAR****Course Code: EET455****Course Name: Electric Vehicles**

Max. Marks: 100

Duration: 3 Hours

PART A (3 x 10 = 30 Marks)**Answer all Questions. Each question carries 3 Marks**

1. List the reasons that led to the evolution of hybrid electric vehicles.
2. List the characteristics of the transmission system in a vehicle.
3. Mention one instance, when the internal combustion engine shall take up extra torque in the drivetrain of a parallel hybrid while being driven.
4. List major components in the drivetrain of an electric vehicle.
5. Discuss the advantage and disadvantage of using DC motors in the drivetrain of electric and hybrid electric vehicles.
6. List any three motors that can be used in the drivetrain of electric and hybrid electric vehicles.
7. Explain the C-rating of a battery
8. Explain the basic fuel cell structure with the help of a neat diagram
9. What are the seven layers of Open System Interconnection (OSI)?
10. What is meant by CAN transfer protocol

PART B (14 x 5 = 70 Marks)**Answer any one full question from each module. Each question carries 14 Marks****Module 1**

11. Explain the history of electric and hybrid electric vehicles. 14
12. Explain the essential characteristics in the power sources intended to be used in electric and hybrid electric vehicles. 14

Module 2

13. a. Highlight various factors that influence the component sizing in the power trains of hybrid electric vehicles. 7
- b. Illustrate how an internal combustion engine is always operated in its maximum operating efficiency region in a hybrid electric vehicle. 7
14. a. Highlight the limitations posed by the battery during the power flow control in electric drive-train topologies. 8
- b. Suggest various methods to minimize the battery size and maximize battery life during the power flow control in electric drive-train topologies. 6

Module 3

15. a. List the desired characteristics of motors used in the drive trains of electric and hybrid electric vehicles. 7
- b. Demonstrate the control of separately excited DC motors in electric vehicles. 7
16. a. Explain the block diagram of electric drive system used in electric vehicles. 7
- b. Demonstrate the Field Oriented Control of Induction Motors in the powertrain of electric vehicles. 7

Module 4

17. Explain about Lithium ion batteries with the help of necessary diagram. Write the chemical reactions involved in it. 14

18. What are the various battery parameters? Briefly explain 14

Module 5

19. Compare various energy management strategies in electric vehicles. 14
20. Discuss about a typical CAN layout in a hybrid electric vehicle with the help of block diagram 14

Syllabus

Module I (6 hrs)

Introduction to Hybrid Electric Vehicles: History of hybrid and electric vehicles, social and environmental importance of hybrid and electric vehicles

Basics of vehicle performance, vehicle power source characterization, transmission characteristics, mathematical models to describe vehicle performance

Module II (8 hrs)

Hybrid Electric Drive-trains: Basic concept of hybrid traction, introduction to various hybrid drive-train topologies, power flow control in hybrid drive-train topologies, Introduction to electric components used in hybrid electric vehicles

Electric Drive-trains: Basic concept of electric traction, introduction to various electric drive-train topologies, power flow control in electric drive-train topologies.

Module III (8 hrs)

Block diagram of electric drive system, Introduction to electric motors used in hybrid and electric vehicles: configuration and control of separately excited DC motors, Induction Motors (block diagram representation of FOC).

Module IV (7 hrs)

Energy Storage: Introduction to Energy Storage Requirements in Hybrid and Electric Vehicles, Battery based energy storage, Fuel Cell based energy storage, Hybridization of different energy storage devices, Introduction to Super capacitor and Hydrogen energy storage.

Module V (7 hrs)

Communications, supporting subsystems: In vehicle networks- CAN

Introduction to energy management strategies used in hybrid and electric vehicles, classification of different energy management strategies, comparison of different energy management strategies

Text/References Books

- 1 Iqbal Hussein, Electric and Hybrid Vehicles: Design Fundamentals, CRC Press, 2003
- 2 NPTEL (notes) – Electrical Engineering – Introduction to Hybrid and Electric Vehicles
- 3 K Sundareswaran, Elementary Concepts of Power Electronic Drives: CRC Press, Taylor & Francis Group

Course Contents and Lecture Schedule

No	Topic	No. of Lectures
1	Introduction to Hybrid Electric Vehicles (6)	
1.1	History of hybrid and electric vehicles,	1
1.2	Social and environmental importance of hybrid and electric vehicles	1
1.3	Basics of vehicle performance	1
1.4	Vehicle power source characterization, transmission characteristics	1
1.5	Mathematical models to describe vehicle performance	1
1.6	Dynamics of electric motion	1
2	Hybrid Electric Drive -trains and Electric drive trains (8)	
2.1	Basic concept of hybrid traction	1
2.2	Introduction to various hybrid drive-train topologies	1

2.3	Power flow control in hybrid drive-train topologies	2
2.4	Basic concept of electric traction	1
2.5	Introduction to various electric drive-train topologies,	1
2.6	Power flow control in electric drive-train topologies	2
3	Electric drive system in electric and hybrid electric vehicles (8)	
3.1	DC motors and induction motors	2
3.2	Introduction to Electric drive system	2
3.3	Separately excited DC motor speed control	1
3.4	V/f control of induction motor drive	1
3.5	Introduction to vector control (block diagram representation only)	2
4	Introduction to Energy Storage Requirements in Hybrid and Electric Vehicles (7)	
4.1	Battery based energy storage	3
4.2	Fuel Cell based energy storage	2
4.3	Hybridization of different energy storage devices	1

	Introduction to Super capacitor and Hydrogen energy storage	1
5	Communications, supporting subsystems and energy management strategies (7)	
5.1	Communications networks	2
5.2	Introduction to energy management strategies used in hybrid and electric vehicles	1
5.3	Classification of different energy management strategies	2
5.4	Comparison of different energy management strategies	2



CODE	COURSE NAME	CATEGORY	L	T	P	CREDIT
EET455	ENERGY MANAGEMENT	OEC	2	1	0	3

Preamble: This course introduces basic knowledge about energy management and audit. Energy management opportunities in electrical and mechanical systems are discussed. Economic analysis of different energy conservation measures is also described.

Prerequisite: Basics of Mechanical Engineering and Basics of Electrical Engineering.

Course Outcomes: After the completion of the course the student will be able to

CO 1	Explain the significance and procedure for energy management and audit.
CO 2	Discuss the energy efficiency and management of electrical loads.
CO 3	Discuss the energy efficiency in boilers and furnaces.
CO 4	Explain the energy management opportunities in HVAC systems
CO 5	Compute the economic feasibility of the energy conservation measures.

Mapping of course outcomes with program outcomes

	PO 1	PO 2	PO 3	PO 4	PO 5	PO 6	PO 7	PO 8	PO 9	PO 10	PO 11	PO 12
CO 1	2					1	1		2	1		1
CO 2	2					1	1					
CO 3	2					1	1					
CO 4	2					1	1					
CO 5	2					1	1					1

Assessment Pattern

Bloom's Category	Continuous Assessment Tests		End Semester Examination
	1	2	
Remember	25	25	50
Understand	15	15	30
Apply	10	10	20
Analyse			
Evaluate			
Create			

Mark distribution

Total Marks	CIE	ESE	ESE Duration
150	50	100	3 hours

Continuous Internal Evaluation Pattern:

Attendance	: 10 marks
Continuous Assessment Test (2 numbers)	: 25 marks
Assignment/Quiz/Course project	: 15 marks

End Semester Examination Pattern: There will be two parts; Part A and Part B. Part A contain 10 questions with 2 questions from each module, having 3 marks for each question. Students should answer all questions. Part B contains 2 questions from each module of which student should answer any one. Each question can have maximum 2 sub-divisions and carry 14 marks.

Course Level Assessment Questions**Course Outcome 1 (CO1):**

1. Define energy management. (K1, PO1, PO6, PO7)
2. List the different phases involved in energy management planning.(K1)
3. State the need for energy audit. (K2, PO1, PO9, PO10, PO12)

Course Outcome 2 (CO2)

1. State the different methods which can be adopted to reduce energy consumption in lighting.(K2, PO1, PO6, PO7)
2. Describe how energy consumption can be reduced by energy efficient motors.(K2, PO1, PO6, PO7)
3. Illustrate the different methods used for controlling peak demand.(K2, PO1, PO6, PO7)

Course Outcome 3 (CO3):

1. List the energy conservation opportunities in boiler.(K1, PO1)
2. Define Steam trapping.(K1, PO1)
3. Demonstrate how fuel economy measures can be done in furnaces.(K2, PO1, PO6, PO7)

Course Outcome 4 (CO4):

1. Define Coefficient of performance(K1, PO1)
2. Demonstrate how waste heat recovery can be done.(K2, PO1, PO6, PO7)
3. Describe how energy consumption can be reduced by cogeneration.(K2,PO1, PO6, PO7)

Course Outcome 5 (CO5):

1. State the need for economic analysis of energy projects.(K2, PO6, PO7, PO12)
2. Define payback period.(K1, PO12)
3. Demonstrate how life cycle costing approach can be used for comparing energy projects.(K3, PO6, PO7, PO12)

Model Question Paper**QP CODE:**

PAGES: 3

Reg. No: _____

Name: _____

APJ ABDUL KALAM TECHNOLOGICAL UNIVERSITY SEVENTH SEMESTER**B.TECH DEGREE EXAMINATION,****MONTH & YEAR****Course Code: EET455****Course Name: ENERGY MANAGEMENT**

Max. Marks: 100

Duration: 3 Hours

PART A (3 x 10 = 30 Marks)**Answer all Questions. Each question carries 3 Marks**

1. Explain what do you mean by energy audit report.
2. Write notes on building management system.
3. Compare the efficacy of different light sources.
4. Write notes on types of industrial loads.
5. Discuss any two opportunities for energy savings in steam distribution.
6. Explain how boiler efficiency can be assessed using direct method.
7. Explain the working of a waste heat recovery system.
8. Write notes on computer aided energy management.
9. What are the advantages and disadvantages of pay back period method.
10. What do you mean by time value of money?

PART B (14 x 5 = 70 Marks)**Answer any one full question from each module. Each question carries 14 Marks****Module 1**

11. a. With the help of case studies, explain any four energy management principles. 8
- b. Explain the different phases of energy management planning. 6
12. a. Explain in detail the different steps involved in a detailed energy audit. 7
- b. Discuss the different instruments used for energy audit. 7

Module 2

13. a. With the help of case studies, explain any four methods to reduce energy consumption in lighting. 8
- b. Explain how energy efficient motors help in reducing energy consumption. 6
14. a. With the help of case studies, explain any four methods to reduce energy consumption in motors. 8
- b. Explain the different methods used for peak demand control. 6

Module 3

15. a. Explain any four energy conservation opportunities in furnaces. 7
- b. What is meant by a steam trap? Explain the operation of the thermostatic steam trap. 7
16. a. Discuss the different energy conservation opportunities in boilers. 7
- b. Explain in detail, the reasons for low furnace efficiency. 7

Module 4

17. a. Explain any five energy saving opportunities in heating, ventilating and air conditioning systems. 7
- b. Explain the working of different types of cogeneration systems. 7
18. a. Explain the impact of evaporator and condenser temperature on the power consumption of a refrigerator. 7
- b. Explain the working of any two waste heat recovery devices. 7

Module 5

19. a. Calculate the energy saving and payback period which can be achieved by replacing a 11 kW, existing motor with an EEM. The capital investment required for EEM is Rs. 40,000/-. Cost of energy/kWh is Rs. 5. The loading is 70% of the rated value for both motors. Efficiency of the existing motor is 81% and that of EEM is 84.7%. 8
- b. Compare internal rate of return method with present value method for the selection of energy projects. 6
20. a. Explain how the average rate of return method can be used for the selection of energy projects. 6
- b. Compare the following motors based on life cycle costing approach. 8

	Motor A	Motor B
Output rating	10 kW	10 kW
Conversion efficiency	80%	90%
Initial cost	Rs. 50000	Rs. 75000
Replacement life	5 yrs	20 yrs
Salvage value	Rs. 2500	Rs. 3000
Annual maintenance and overhead costs	Rs. 1000	Rs. 1000
Electricity cost	Rs. 5 per kWh	
Operating schedule	8 hrs/day, 22 days/ month	

Syllabus

Module 1 (7 hours)

Energy Management - General Principles and Planning:

General principles of energy management and energy management planning

Energy Audit: Definition, need, types and methodologies. Instruments for energy audit, Energy audit report - Power quality audit

Energy conservation in buildings: ECBC code (basic aspects), Building Management System (BMS).

Module 2 (8 hours)

Energy management in Electricity Utilization:

Energy management opportunities in Lighting and Motors, Electrolytic Process and Electric heating.

Types of industrial loads.

Peak demand controls and methodologies

Module 3 (8 hours)

Energy management in boilers and furnaces:

Types of boilers, Combustion in boilers, Performances evaluation, Feed water treatment, Blow down, Energy conservation opportunities in boiler.

Properties of steam, Assessment of steam distribution losses, Steam leakages, Steam trapping, Condensate and flash steam recovery system, Identifying opportunities for energy savings.

Classification, General fuel economy measures in furnaces, Excess air, Heat Distribution, Temperature control, Draft control.

Module 4 (6 hours)

Energy management in HVAC systems:

HVAC system: Coefficient of performance, Capacity, Factors affecting Refrigeration and Air conditioning system performance and savings opportunities.

Classification and Advantages of Waste Heat Recovery system, analysis of waste heat recovery for Energy saving opportunities

Cogeneration-Types and Schemes, Optimal operation of cogeneration plants- Case study.

Computer aided energy management

Module 5 (6 hours)

Energy Economics:

Economic analysis methods-cash flow model, time value of money, evaluation of proposals, pay-back method, average rate of return method, internal rate of return method, present value method, life cycle costing approach, Case studies.

Text/ Reference Books

1. Albert Thumann, William J. Younger, Handbook of Energy Audits, CRC Press, 2003.
2. Charles M. Gottschalk, Industrial energy conservation, John Wiley & Sons, 1996.
3. Craig B. Smith, Energy management principles, Pergamon Press. 4. D. Yogi Goswami, Frank Kreith, Energy Management and Conservation Handbook, CRC Press, 2007
5. G.G. Rajan, Optimizing energy efficiencies in industry -, Tata McGraw Hill, Pub. Co., 2001.
6. IEEE recommended practice for energy management in industrial and commercial facilities,
7. IEEE std 739 - 1995 (Bronze book).
8. M Jayaraju and Premlet, Introduction to Energy Conservation and Management, Phasor Books, 2008
9. Paul O'Callaghan, Energy management, McGraw Hill Book Co.
10. Wayne C. Turner, Energy management Hand Book - - The Fairmount Press, Inc., 1997.

Course Contents and Lecture Schedule

No	Topic	No. of Lectures
1	Energy Management - General Principles and Planning; Energy audit (7 hours)	
1.1	Energy management; General principles of energy management	2
1.2	Energy management planning	1
1.3	Energy audit: Definition, need, types and methodologies.	2
1.4	Instruments for energy audit, Energy audit report Power quality audit	2
2	Energy management in Electricity Utilization (8 hours)	
2.1	Energy management opportunities in Lighting.	2
2.2	Energy management opportunities in Motors.	2
2.3	Electrolytic Process and Electric heating.	2
2.4	Types of Industrial Loads. Peak Demand controls and Methodologies	2
3	Energy management in boilers and furnaces (8 hours)	
3.1	Types of boilers, Combustion in boilers, Performances evaluation, Feed water treatment, Blow down, Energy conservation opportunities in boiler.	2
3.2	Properties of steam, Assessment of steam distribution losses, Steam leakages, Steam trapping	2
3.3	Condensate and flash steam recovery system, Identifying opportunities for energy savings.	2
3.4	Classification, General fuel economy measures in furnaces, Excess air, Heat Distribution, Temperature control, Draft control, Waste heat recovery.	2
4	Energy management in HVAC systems (6 hours)	
4.1	HVAC system: Coefficient of performance, Capacity	1

4.2	Factors affecting Refrigeration and Air conditioning system performance and savings opportunities.	1
4.3	Classification and Advantages of Waste Heat Recovery system, analysis of waste heat recovery for Energy saving opportunities	2
4.4	Cogeneration-Types and Schemes, Optimal operation of cogeneration plants	2
5	Energy Economics (6 hours)	
5.1	Economic analysis methods	1
5.2	Cash flow model, time value of money, evaluation of proposals	1
5.3	Pay-back method, average rate of return method, internal rate of return method	2
5.4	Present value method, life cycle costing approach, Case studies.	2

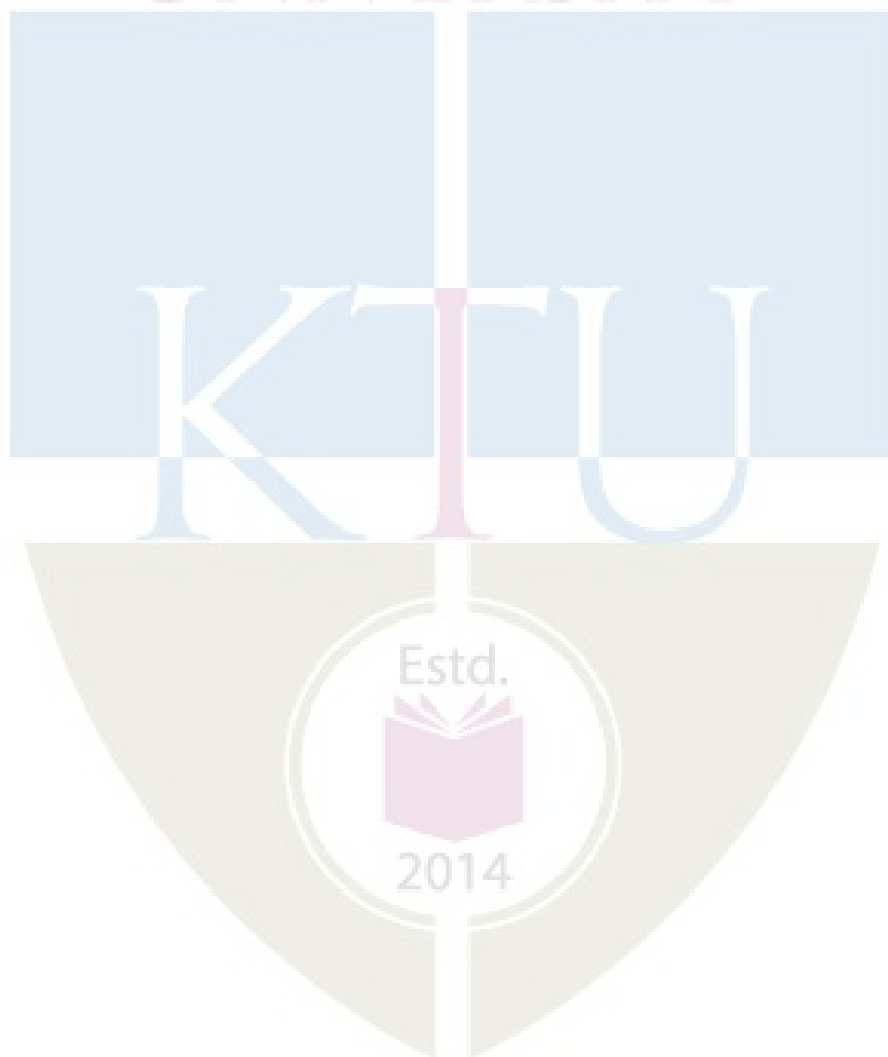

MCN401	INDUSTRIAL SAFETY ENGINEERING	Category	L	T	P	CREDIT
		OEC	2	1	0	3

Preamble: The course is intended to give knowledge of various safety management principles, various safety systems, various machine guarding devices, hazard identification techniques, energy sources, systems & applications and the need in the present context. Learners will be able to compare different hazard identification tools and choose the most appropriate based on the nature of industry. It aims to equip students in working with projects and to take up research work in connected areas

Prerequisite: Nil

Course Outcomes: After the completion of the course the student will be able to

CO1	Describe the theories of accident causation and preventive measures of industrial accidents. (Cognitive Knowledge level: Understand)
CO2	Explain about personal protective equipment, its selection, safety performance & indicators and importance of housekeeping. (Cognitive Knowledge level: Understand)
CO3	Explain different issues in construction industries. (Cognitive Knowledge level: Understand)
CO4	Describe various hazards associated with different machines and mechanical material handling. (Cognitive Knowledge level: Understand)
CO5	Utilise different hazard identification tools in different industries with the knowledge of different types of chemical hazards. (Cognitive Knowledge level: Apply)

Mapping of course outcomes with program outcomes

	PO1	PO2	PO3	PO4	PO5	PO6	PO7	PO8	PO9	PO10	PO11	PO12
CO1	2	2				2	2	2				1
CO2	2	1	2		1	1	1	1				1
CO3	2	2	2		1	1	1	1	1	1		1
CO4	2	2	2		1	1	1	1	1	1		1
CO5	2	2	2	1	1	1	1	1	1	1		1

Abstract POs defined by National Board of Accreditation				
PO1	Engineering Knowledge		PO7	Environment and Sustainability
PO2	Problem Analysis		PO8	Ethics
PO3	Design/Development of solutions		PO9	Individual and team work
PO4	Conduct investigations of complex problems		PO10	Communication
PO5	Modern tool usage		PO11	Project Management and Finance
PO6	The Engineer and Society		PO12	Life long learning

Assessment Pattern

	Continuous Assessment Tests		End Semester Examination
	1	2	
Remember	10	10	10
Understand	20	20	20
Apply	20	20	70
Analyse			
Evaluate			
Create			

Mark distribution:

Total Marks	CIE Marks	ESE Marks	ESE Duration
150	50	100	3 hours

Continuous Internal Evaluation Pattern:

Attendance : 10 marks

Continuous Assessment - Test : 25 marks

Continuous Assessment - Assignment : 15 marks

Internal Examination Pattern:

Each of the two internal examinations has to be conducted out of 50 marks. First series test shall be preferably conducted after completing the first half of the syllabus and the second series test shall be preferably conducted after completing remaining part of the syllabus. There will be two parts: Part A and Part B. Part A contains 5 questions (preferably, 2 questions each from the completed modules and 1 question from the partly completed module), having 3 marks for each question adding up to 15 marks for part A. Students should answer all questions from Part A. Part B contains 7 questions (preferably, 3 questions each from the completed modules and 1 question from the partly completed module), each with 7 marks. Out of the 7 questions, a student should answer any 5.

End Semester Examination Pattern:

There will be two parts; Part A and Part B. Part A contains 10 questions with 2 questions from each module, having 3 marks for each question. Students should answer all questions. Part B contains 2 questions from each module of which a student should answer any one. Each question can have maximum 2 sub-divisions and carries 14 marks.

Syllabus

MCN401- Industrial Safety Engineering (35 hrs)

Module I (safety introduction- 5 hrs)

Need for safety. Safety and productivity. Definitions: Accident, Injury, Unsafe act, Unsafe Condition, Dangerous Occurrence, Reportable accidents. Theories of accident causation. Safety organization- objectives, types, functions, Role of management, supervisors, workmen, unions, government and voluntary agencies in safety. Safety policy. Safety Officer-responsibilities, authority. Safety committee-need, types, advantages.

Module II (Personal protection in work environment- 7 hrs)

Personal protection in the work environment, Types of PPEs, Personal protective equipment- respiratory and non-respiratory equipment. Standards related to PPEs. Monitoring Safety Performance: Frequency rate, severity rate, incidence rate, activity rate. Housekeeping: Responsibility of management and employees. Advantages of good housekeeping. 5 s of housekeeping. Work permit system- objectives, hot work and cold work permits. Typical industrial models and methodology. Entry into confined spaces.

Module III (safety issues in construction- 7 hrs)

Introduction to construction industry and safety issues in construction Safety in various construction operations – Excavation and filling – Under-water works – Under-pinning & Shoring – Ladders & Scaffolds – Tunneling – Blasting – Demolition – Confined space – Temporary Structures. Familiarization with relevant Indian Standards and the National Building Code provisions on construction safety. Relevance of ergonomics in construction safety. Ergonomics Hazards - Musculoskeletal Disorders and Cumulative Trauma Disorders.

Module IV (safety hazards in machines- 8 hrs)

Machinery safeguard-Point-of-Operation, Principle of machine guarding -types of guards and devices. Safety in turning, and grinding. Welding and Cutting-Safety Precautions of Gas

welding and Arc Welding. Material Handling-Classification-safety consideration- manual and mechanical handling. Handling assessments and techniques- lifting, carrying, pulling, pushing, palletizing and stocking. Material Handling equipment-operation & maintenance. Maintenance of common elements-wire rope, chains slings, hooks, clamps. Hearing Conservation Program in Production industries.

Module V (hazard identification and analysis- 8 hrs)

Hazard and risk, Types of hazards –Classification of Fire, Types of Fire extinguishers, fire explosion and toxic gas release, Structure of hazard identification and risk assessment. Identification of hazards: Inventory analysis, Fire and explosion hazard rating of process plants - The Dow Fire and Explosion Hazard Index, Preliminary hazard analysis, Hazard and Operability study (HAZOP) – methodology, criticality analysis, corrective action and follow-up. Control of Chemical Hazards, Hazardous properties of chemicals, Material Safety Data Sheets (MSDS).

Text Books:

1. R.K Jain (2000) Industrial Safety, Health and Environment management systems, Khanna Publications.
2. Paul S V (2000), Safety management System and Documentation training Programme handbook, CBS Publication.
3. Krishnan, N.V. (1997). *Safety management in Industry*. Jaico Publishing House, New Delhi.
4. John V. Grimaldi and Rollin H.Simonds. (1989) *Safety management*. All India Traveller Book Seller, Delhi.
5. Ronald P. Blake. (1973). *Industrial safety*. Prentice Hall, New Delhi.
6. Alan Waring. (1996). *Safety management system*. Chapman & Hall, England.
7. Vaid, K.N., (1988). Construction safety management. National Institute of Construction Management and Research, Mumbai.

8. AIChE/CCPS. (1992). *Guidelines for Hazard Evaluation Procedures*. (second edition). Centre for Chemical Process Safety, American Institute of Chemical Engineers, New York.

Course Level Assessment Questions:

Course Outcome 1 (CO1):

1. Which are the various accident causation theories? Explain.
2. Define terms: Accident, Reportable accident, Dangerous occurrence.

Course Outcome 2 (CO2):

1. Discuss different types of personal protective equipment
2. Discuss about how to compare the safety performance of two industries.
3. Discuss the significance of work permit system in accident prevention.

Course Outcome 3 (CO3):

1. Distinguish ladders and scaffolds along with their safety features.
2. Discuss the safety requirement for a confined space entry.
3. Explain the important provision in the National Building Code.

Course Outcome 4 (CO4):

1. Explain the various principles used in machine guarding.
2. Explain the issues in mechanical material handling.

Course Outcome 5 (CO5):

1. Selection of different types of fire extinguishers accordance to type of fire.
2. Conduct a HAZOP study for a batch reactor of your choice.
3. Determine different types of Chemical hazards associated with industries

MODEL QUESTION PAPER
APJ ABDUL KALAM TECHNOLOGICAL UNIVERSITY
VII SEMESTER B. TECH DEGREE EXAMINATION
MCN401- INDUSTRIAL SAFETY ENGINEERING

Maximum: 100 Marks

Duration: 3 hours

PART A

Answer all questions, each question carries 3 marks

1. Differentiate Unsafe act and Unsafe conditions with suitable examples
2. Discuss the significance of a safety committee in improving the safety performance of an industry
3. Which are the different types of permit? Highlight its suitability.
4. Which are five 'S' used in housekeeping?
5. List the various safety features of ladders.
6. How safety of the workers can be ensured during a demolition operations.
7. Which are the hazards associated with manual material handling?
8. Discuss the safety issues of Gas welding operations.
9. Differentiate Hazard and Risk.
10. Why MSDS is mandatory for chemical products.

(10 X 3 = 30 Marks)

PART B

Answer one full question from each module

Module 1

11. List the various accident causation theories and explain any one in details. (14 Marks)
12. a) Discuss the significance of safety policy in reducing the accidents. (4 Marks)
b) Safety and productivity are the two sides of a coin'. Are you agreeing with this statement? Explain with your arguments. (10 Marks)

Module 2

13. a) Classify the personal protective equipment. List the suitability of at least fifteen types of PPEs. (10 Marks)

b) How will you calculate the frequency rate? Explain with an example. (4 Marks)

14. a) How will you compare the safety performance of two industries? Explain with suitable example. (10 Marks)

b) Which are the steps to be followed in confined space entry to protect the life of a worker. (4 Marks)

Module 3

15. Discuss the safety and fire protection facilities required for a high rise building as per National building code. (14 Marks)

16. a) Identify the various hazards during the different stages of building construction. (7 Marks)

b) Discuss the important types of ergonomic hazards associated with industries. (7 Marks)

Module 4

17. Which are the various types of machine guarding devices used in industries. Discuss the suitability of each machine guarding device. (14 Marks)

18. With suitable sketches briefly explain seven defects of wire ropes. (14 Marks)

Module 5

19. What is Hazard and Operability Analysis? How do you conduct a HAZOP analysis? (14 Marks)

20. Discuss about different types of chemical hazards. (14 Marks)

Course Contents and Lecture Schedule

No.	Topic	No. of Lectures/ Tutorials L-T
1	Introduction to Industrial safety Engineering	
1.1	Need for safety. Safety and productivity. Definitions: Accident, Injury, Unsafe act, Unsafe Condition, Dangerous Occurrence. Reportable accidents	1
1.2	Theories of accident causation. Safety organization.	2
1.3	Role of management, supervisors, workmen, unions, government and voluntary agencies in safety.	3
1.4	Safety Officer-responsibilities, authority.	4
1.5	Safety committee-need, types, advantages.	5
2	Personal protection in the work environment	
2.1	Types of PPEs, respiratory and non-respiratory equipment.	6
2.2	Standards related to PPEs	7
2.3	Monitoring Safety Performance: Frequency rate, severity rate	8,
2.4	Monitoring Safety Performance: incidence rate, activity rate.	9
2.5	Housekeeping: Responsibility of management and employees. Advantages of good housekeeping. 5 s of housekeeping.	10
2.6	Work permit system- objectives, hot work and cold work permits.	11
2.7	Typical industrial models and methodology. Entry into confined spaces.	12
3	Introduction to construction industry and safety	
3.1	Excavation and filling – Under-water works – Under-pinning & Shoring	13
3.2	Ladders & Scaffolds – Tunneling	14
3.3	Blasting –Demolition – Confined space	15
3.4	Familiarization with relevant Indian Standards and the National Building Code provisions on construction safety.	16
3.5	Relevance of ergonomics in construction safety.	17
3.6	Ergonomics Hazards	18
3.7	Musculoskeletal Disorders and Cumulative Trauma Disorders.	19
4	Machinery safeguard	

4.1	Point-of-Operation, Principle of machine guarding -	20
4.2	Types of guards and devices.	21
4.3	Safety in Power Presses, primary & secondary operations - shearing -bending - rolling – drawing.	22
4.4	Safety in turning, boring, milling, planning and grinding.	23
4.5	Welding and Cutting-Safety Precautions of Gas welding and Arc Welding,	24
4.6	Cutting and Finishing.	25
4.7	Material Handling-Classification-safety consideration- manual and mechanical handling. Handling assessments and techniques- lifting, carrying, pulling, pushing, palletizing and stocking.	26
4.8	Material Handling equipment-operation & maintenance. Maintenance of common elements-wire rope, chains slings, hooks, clamps	27
5	Hazard identification	
5.1	Hazard and risk, Types of hazards – Classification of Fire	28
5.2	Types of Fire extinguishers fire, explosion and toxic gas release.	29
5.3	Inventory analysis, Fire and explosion hazard rating of process plants -	30
5.4	The Dow Fire and Explosion Hazard Index.	31
5.5	Preliminary hazard analysis, Hazard and Operability study (HAZOP)	32
5.6	Chemical hazard- Classifications, Control of Chemical Hazards.	33
5.7	Hazardous properties of chemicals	34
5.8	Material Safety Data Sheets (MSDS).	35

EEL411	CONTROL SYSTEMS LAB	CATEGORY	L	T	P	CREDIT
		PCC	0	0	3	2

Preamble: This Laboratory Course provides a platform for modelling and analysis of linear and nonlinear systems with the help of hardware and software tools in the control framework.

Prerequisite: EET302 Linear Control Systems, EET305 Signals and Systems

Course Outcomes: After the completion of the course the student will be able to

CO 1	Demonstrate the knowledge of simulation tools for control system design.
CO 2	Develop the mathematical model of a given physical system by conducting appropriate experiments.
CO 3	Analyse the performance and stability of physical systems using classical and advanced control approaches.
CO 4	Design controllers for physical systems to meet the desired specifications.

Mapping of course outcomes with program outcomes

	PO 1	PO 2	PO 3	PO 4	PO 5	PO 6	PO 7	PO 8	PO 9	PO 10	PO 11	PO 12
CO 1	3	3	2	3	3			3	3	3		3
CO 2	3	3	3	3	3			3	3	3		3
CO 3	3	3	3	3	3			3	3	3		3
CO 4	3	3	3	3	3			3	3	3		3

Assessment Pattern

Mark distribution

Total Marks	CIE	ESE	ESE Duration
-------------	-----	-----	--------------

150	75	75	3 hours
-----	----	----	---------

Continuous Internal Evaluation Pattern:

Attendance : 15 marks

Continuous Assessment : 30 marks

Internal Test : 30 marks

End Semester Examination Pattern: The following guidelines should be followed regarding award of marks

(a) Preliminary work : 15 Marks

(b) Implementing the work/Conducting the experiment : 10 Marks

(c) Performance, result and inference (usage of equipments and troubleshooting) : 25 Marks

(d) Viva voce : 20 marks

(e) Record : 5 Marks

General instructions:

Practical examination to be conducted immediately after the second series test after completing 12 experiments out of the 18 experiments given below. Evaluation is a serious process that is to be conducted under the equal responsibility of both the internal and external examiners. The number of candidates evaluated per day should not exceed 20. Students shall be allowed for the University examination only on submitting the duly certified record. The external examiner shall endorse the record.

Reference Books

1. Richard C. Dorf and Robert H. Bishop, Modern Control Systems, Eleventh Edition, Pearson Education 2009.
2. Katsuhiko Ogatta, Modern Control Engineering, Fourth Edition, Pearson Education, 2002.

List of Exercises/Experiments: (Lab experiments may be given considering 12 sessions of 3 hours each.)

1. Simulation tools like MATLAB/ SCILAB or equivalent may be used.
2. All experiments done by the students in addition to 12 experiments may be treated as beyond syllabus experiments.

Experiment No.	Name of the experiment
1	<p>Step response of a second order system.</p> <p>Objective: Design a second order system (eg: RLC network) to analyse the following:</p> <ul style="list-style-type: none"> A. The effect of damping factor (ξ: 0, <1,=1,>1) on the unit step response using simulation study (M-File and SIMULINK). B. Verification of the delay time, rise time, peak overshoot and settling time with the theoretical values. C. Performance analysis of hardware setup and comparison with the simulation results.
2	<p>Performance Analysis using Root-Locus Method.</p> <p>Objective: Plot the root locus of the given transfer function to analyse the following using simulation:</p> <ul style="list-style-type: none"> A. Verification of the critical gain, w_o with the theoretical values B. The effect of controller gain K on the stability C. The sensitivity analysis by giving small perturbations in given poles and zeros D. The effect of the addition of poles and zeros on the given system.

3	<p>Stability Analysis by Frequency Response Methods.</p> <p>Objective: Plot the i) Bode plot and ii) Nyquist plot of the given transfer functions to analyse the following using simulation:</p> <ul style="list-style-type: none"> A. Determination of Gain Margin and Phase Margin B. Verification of GM and PM with the theoretical values C. The effect of controller gain K on the stability, D. The effect of the addition of poles and zeros on the given system (especially the poles at origin).
4	<p>Realisation of lead compensator.</p> <p>Objective: Design, set up and analyse the gain and phase plots of a lead compensator by hardware experimentation using i) passive elements and ii) active components..</p>
5	<p>Realisation of lag compensator.</p> <p>Objective: Design, set up and analyse the gain and phase plots of a lag compensator by hardware experimentation using i) passive elements and ii) active components..</p>
6	<p>Design of compensator in frequency domain and time domain.</p> <p>Objective: Design a compensator for the given system to satisfy the given specifications</p> <ul style="list-style-type: none"> A. Time domain specifications using MATLAB B. Frequency domain specifications using MATLAB
7	<p>State space model for analysis and design</p> <p>Objective: Study and analysis of state variable model of a given system (eg. DC Motor speed control/ Servo motor/etc) and design a controller by pole-placement technique using MATLAB based tool boxes.</p> <ul style="list-style-type: none"> A. Determine the open loop stability, controllability and observability B. Analyse the effect of system parameters on eigen values and system performance.

C. Design a controller by pole-placement technique.

8	<p>PID Controller Design</p> <p>Objective: Design and analysis of a PID controller for a given system (eg. DC Motor speed control/ Servo motor/etc) using SIMULINK/ MATLAB based tool boxes</p> <p>A. Design of PID controller to meet the given specifications</p> <p>B. Study the effect of tuning of PID controller on the above system.</p>
9	<p>Phase plane analysis of nonlinear autonomous systems</p> <p>Objective: Study and analysis of phase trajectory of a given nonlinear autonomous system using state space model in Simulation tools.</p> <p>A. Determination and verification of the singular points,</p> <p>B. Stability Analysis of the system at various singular points from phase portraits.</p>
10	<p>Transfer Function of Armature and Field Controlled DC Motor</p> <p>Objective: Obtain the transfer function of the armature and field controlled DC motor by experiment.</p>
11	<p>Synchro Transmitter and Receiver.</p> <p>Objective: Plot and study the different performance characteristics of Synchro transmitter- receiver units in Direct mode and Differential mode.</p>
12	<p>Transfer function of Separately excited DC Generator.</p> <p>Objective: Obtain the open loop transfer function of a separately excited DC Generator by experiment.</p>

13	Transfer function of A.C. Servo motor. Objective: Obtain the open loop transfer function of AC Servo motor by experiment.
14	Performance of a typical process control system Objective: Study of performance characteristics and response analysis of a typical temperature/ Flow/ Level control system.
15	Closed loop performance of inverted pendulum. Objective: Study of performance characteristics of inverted pendulum by experiment. A. Determine the various unknown parameters of an inverted pendulum experimentally, B. Obtain and analyse the non-linear and linearised models, C. Design and implement various state feedback controllers to analyse the performance of the system.
16	Performance analysis of magnetic levitation system. Objective: Study of performance of magnetic levitation system by experiment. A. Obtain and analyse the dynamics of a magnetic levitation system, B. Design and implement various loop controllers to analyse the performance of this experimental system while tracking in presence/absence of disturbances.
17	Closed loop performance of Twin rotor system Objective: Study of performance characteristics of Twin rotor system by experiment.

Mass Spring Damper system

Objective: Study of performance characteristics of Mass-Damper-Spring system by experiment.

18

- A. Determine the various unknown parameters of a mass spring damper system experimentally to obtain transfer function/ state space models,
- B. Design and implement various state feedback controllers to analyse the performance of the system while regulation and tracking

APJ ABDUL KALAM
TECHNOLOGICAL
UNIVERSITY

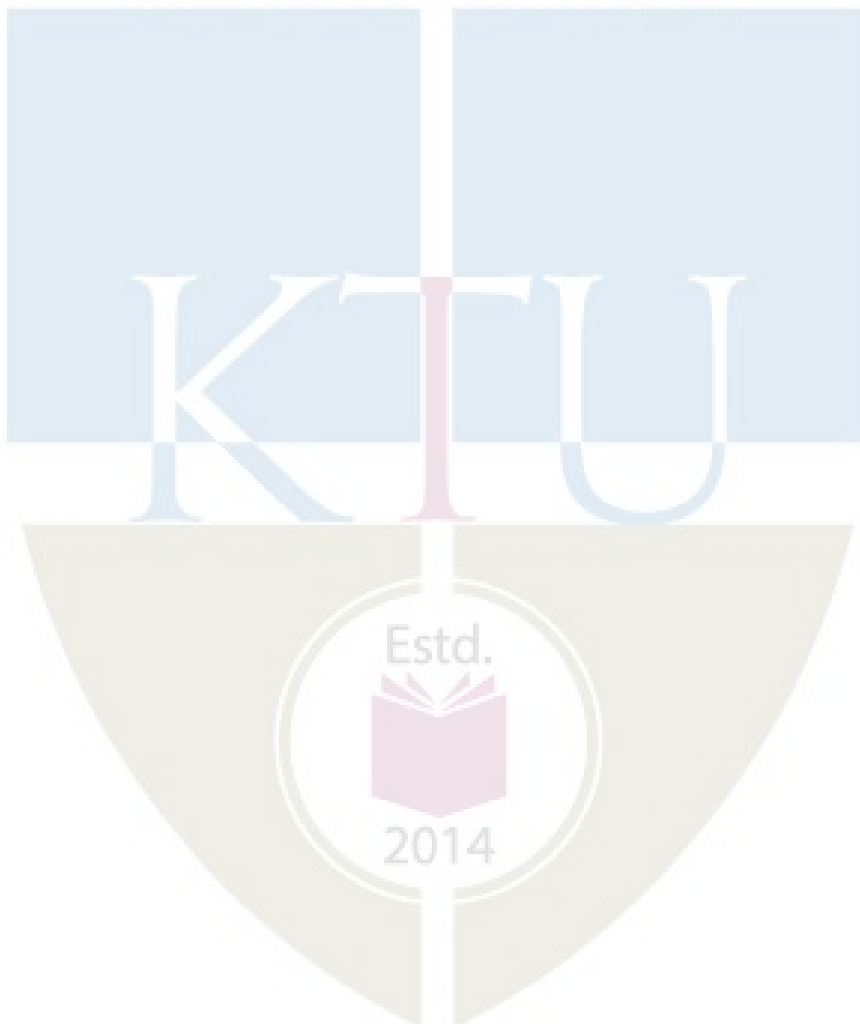

EEQ413	SEMINAR	CATEGORY	L	T	P	CREDIT
		PWS	0	0	3	2

Preamble: The course ‘Seminar’ is intended to enable a B.Tech graduate to read, understand, present and prepare report about an academic document. The learner shall search in the literature including peer reviewed journals, conference, books, project reports etc., and identify an appropriate paper/thesis/report in her/his area of interest, in consultation with her/his seminar guide. This course can help the learner to experience how a presentation can be made about a selected academic document and also empower her/him to prepare a technical report.

Course Objectives:

- To do literature survey in a selected area of study.
- To understand an academic document from the literature and to give a presentation about it.
- To prepare a technical report.

Course Outcomes [COs] : After successful completion of the course, the students will be able to:

CO1	Identify academic documents from the literature which are related to her/his areas of interest (Cognitive knowledge level: Apply).
CO2	Read and apprehend an academic document from the literature which is related to her/ his areas of interest (Cognitive knowledge level: Analyze).
CO3	Prepare a presentation about an academic document (Cognitive knowledge level: Create).
CO4	Give a presentation about an academic document (Cognitive knowledge level: Apply).
CO5	Prepare a technical report (Cognitive knowledge level: Create).

Mapping of course outcomes with program outcomes:

	PO1	PO2	PO3	PO4	PO5	PO6	PO7	PO8	PO9	PO10	PO11	PO12
CO1	2	2	1	1		2	1					3
CO2	3	3	2	3		2	1					3
CO3	3	2			3			1		2		3
CO4	3				2			1		3		3
CO5	3	3	3	3	2	2		2		3		3

Abstract POs defined by National Board of Accreditation

PO#	Broad PO	PO#	Broad PO
PO1	Engineering Knowledge	PO7	Environment and Sustainability
PO2	Problem Analysis	PO8	Ethics
PO3	Design/Development of solutions	PO9	Individual and team work
PO4	Conduct investigations of complex problems	PO10	Communication
PO5	Modern tool usage	PO11	Project Management and Finance
PO6	The Engineer and Society	PO12	Life long learning

General Guidelines

- The Department shall form an Internal Evaluation Committee (IEC) for the seminar with academic coordinator for that program as the Chairperson/Chairman and seminar coordinator & seminar guide as members. During the seminar presentation of a student, all members of IEC shall be present.
- Formation of IEC and guide allotment shall be completed within a week after the University examination (or last working day) of the previous semester.
- Guide shall provide required input to their students regarding the selection of topic/paper.
- Choosing a seminar topic: The topic for a UG seminar should be current and broad based rather than a very specific research work. It's advisable to choose a topic for the Seminar to be closely linked to the final year project area. Every member of the project team could choose or be assigned Seminar topics that covers various aspects linked to the Project area.
- A topic/paper relevant to the discipline shall be selected by the student during the semester break.
- Topic/Paper shall be finalized in the first week of the semester and shall be submitted to the IEC.
- The IEC shall approve the selected topic/paper by the second week of the semester.
- Accurate references from genuine peer reviewed published material to be given in the report and to be verified.

Evaluation pattern

Total marks: 100, only CIE, minimum required to pass 50

Seminar Guide: 20 marks (Background Knowledge – 10 (The guide shall give deserving marks for a candidate based on the candidate's background knowledge about the topic selected), Relevance of the paper/topic selected – 10).

Seminar Coordinator: 20 marks (Seminar Diary – 10 (Each student shall maintain a seminar diary and the guide shall monitor the progress of the seminar work on a weekly basis and shall approve the entries in the seminar diary during the weekly meeting with the student), Attendance – 10).

Presentation: 40 marks to be awarded by the IEC (Clarity of presentation – 10, Interactions – 10 (to be based on the candidate's ability to answer questions during the interactive session of her/his presentation), Overall participation – 10 (to be given based on her/his involvement during interactive sessions of presentations by other students), Quality of the slides – 10).

Report: 20 marks to be awarded by the IEC (check for technical content, overall quality, templates followed, adequacy of references etc.).



EED415	PROJECT PHASE I	CATEGORY	L	T	P	CREDIT
		PWS	0	0	6	2

Preamble: The course ‘Project Work’ is mainly intended to evoke the innovation and invention skills in a student. The course will provide an opportunity to synthesize and apply the knowledge and analytical skills learned, to be developed as a prototype or simulation. The project extends to 2 semesters and will be evaluated in the 7th and 8th semester separately, based on the achieved objectives. One third of the project credits shall be completed in 7th semester and two third in 8th semester. It is recommended that the projects may be finalized in the thrust areas of the respective engineering stream or as interdisciplinary projects. Importance should be given to address societal problems and developing indigenous technologies.

Course Objectives

- To apply engineering knowledge in practical problem solving.
- To foster innovation in design of products, processes or systems.
- To develop creative thinking in finding viable solutions to engineering problems.

Course Outcomes [COs] :After successful completion of the course, the students will be able to:

CO1	Model and solve real world problems by applying knowledge across domains (Cognitive knowledge level: Apply).
CO2	Develop products, processes or technologies for sustainable and socially relevant applications (Cognitive knowledge level: Apply).
CO3	Function effectively as an individual and as a leader in diverse teams and to comprehend and execute designated tasks (Cognitive knowledge level: Apply).
CO4	Plan and execute tasks utilizing available resources within timelines, following ethical and professional norms (Cognitive knowledge level: Apply).
CO5	Identify technology/research gaps and propose innovative/creative solutions (Cognitive knowledge level: Analyze).
CO6	Organize and communicate technical and scientific findings effectively in written and oral forms (Cognitive knowledge level: Apply).

Mapping of course outcomes with program outcomes

	PO1	PO2	PO3	PO4	PO5	PO6	PO7	PO8	PO9	PO10	PO11	PO12
CO1	2	2	2	1	2	2	2	1	1	1	1	2
CO2	2	2	2		1	3	3	1	1		1	1
CO3									3	2	2	1
CO4					2			3	2	2	3	2
CO5	2	3	3	1	2							1
CO6					2			2	2	3	1	1

Abstract POs defined by National Board of Accreditation			
PO#	Broad PO	PO#	Broad PO
PO1	Engineering Knowledge	PO7	Environment and Sustainability
PO2	Problem Analysis	PO8	Ethics
PO3	Design/Development of solutions	PO9	Individual and team work
PO4	Conduct investigations of complex problems	PO10	Communication
PO5	Modern tool usage	PO11	Project Management and Finance
PO6	The Engineer and Society	PO12	Lifelong learning

PROJECT PHASE I

Phase 1 Target

- Literature study/survey of published literature on the assigned topic
- Formulation of objectives
- Formulation of hypothesis/ design/ methodology
- Formulation of work plan and task allocation.
- Block level design documentation
- Seeking project funds from various agencies
- Preliminary Analysis/Modeling/Simulation/Experiment/Design/Feasibility study
- Preparation of Phase 1 report

Evaluation Guidelines & Rubrics

Total: 100 marks (Minimum required to pass: 50 marks).

- Project progress evaluation by guide: 30 Marks.
- Interim evaluation by the Evaluation Committee: 20 Marks.
- Final Evaluation by the Evaluation Committee: 30 Marks.
- Project Phase - I Report (By Evaluation Committee): 20 Marks.

(The evaluation committee comprises HoD or a senior faculty member, Project coordinator and project supervisor).

Evaluation by the Guide

ELECTRICAL AND ELECTRONICS

The guide/supervisor shall monitor the progress being carried out by the project groups on a regular basis. In case it is found that progress is unsatisfactory it shall be reported to the Department Evaluation Committee for necessary action. The presence of each student in the group and their involvement in all stages of execution of the project shall be ensured by the guide. Project evaluation by the guide: 30 Marks. This mark shall be awarded to the students in his/her group by considering the following aspects:

Topic Selection: innovativeness, social relevance etc. (2)

Problem definition: Identification of the social, environmental and ethical issues of the project problem. (2)

Purpose and need of the project: Detailed and extensive explanation of the purpose and need of the project. (3)

Project Objectives: All objectives of the proposed work are well defined; Steps to be followed to solve the defined problem are clearly specified. (2)

Project Scheduling & Distribution of Work among Team members: Detailed and extensive Scheduling with timelines provided for each phase of project. Work breakdown structure well defined. (3)

Literature survey: Outstanding investigation in all aspects. (4)

Student's Diary/ Daily Log: The main purpose of writing daily diary is to cultivate the habit of documenting and to encourage the students to search for details. It develops the students' thought process and reasoning abilities. The students should record in the daily/weekly activity diary the day to day account of the observations, impressions, information gathered and suggestions given, if any. It should contain the sketches & drawings related to the observations made by the students. The daily/weekly activity diary shall be signed after every day/week by the guide. (7)

Individual Contribution: The contribution of each student at various stages. (7)

2014

EVALUATION RUBRICS for PROJECT Phase I: Interim Evaluation

No.	Parameters	Marks	Poor	Fair	Very Good	Outstanding
1-a	Topic identification, selection, formulation of objectives and/or literature survey. (Group assessment) [CO1]	10	The team has failed to come with a relevant topic in time. Needed full assistance to find a topic from the guide. They do not respond to suggestions from the evaluation committee and/or the guide. No literature review was conducted. The team tried to gather easy information without verifying the authenticity. No objectives formed yet.	The team has identified a topic. The originally selected topic lacks substance and needs to be revised. There were suggestions given to improve the relevance and quality of the project topic. Only a few relevant references were consulted/ studied and there is no clear evidence to show the team's understanding on the same. Some objectives identified, but not clear enough.	Good evidence of the group thinking and brainstorming on what they are going to build. The results of the brainstorming are documented and the selection of topic is relevant. The review of related references was good, but there is scope of improvement. Objectives formed with good clarity, however some objectives are not realistic enough.	The group has brainstormed in an excellent manner on what they were going to build. The topic selected is highly relevant, real world problem and is potentially innovative. The group shows extreme interest in the topic and has conducted extensive literature survey in connection with the topic. The team has come up with clear objectives which are feasible.
			(0 – 3 Marks)	(4 – 6 Marks)	(7 - 9 Marks)	(10 Marks)
1-b	Project Planning, Scheduling and Resource/ Tasks Identification and allocation. (Group assessment) [CO4]	10	No evidence of planning or scheduling of the project. The students did not plan what they were going to build or plan on what materials / resources to use in the project. The students do not have any idea on the budget required. The team has not yet decided on who does what. No project journal kept.	Some evidence of a primary plan. There were some ideas on the materials /resources required, but not really thought out. The students have some idea on the finances required, but they have not formalized a budget plan. Schedules were not prepared. The project journal has no details. Some evidence on task allocation among the team members.	Good evidence of planning done. Materials were listed and thought out, but the plan wasn't quite complete. Schedules were prepared, but not detailed, and needs improvement. Project journal is presented but it is not complete in all respect / detailed. There is better task allocation and individual members understand about their tasks. There is room for improvement.	Excellent evidence of enterprising and extensive project planning. Gantt charts were used to depict detailed project scheduling. A project management/version control tool is used to track the project, which shows familiarity with modern tools. All materials / resources were identified and listed and anticipation of procuring time is done. Detailed budgeting is done. All tasks were identified and incorporated in the schedule. A well-kept project journal shows evidence for all the above, in addition to the interaction with the project guide. Each member knows well about their individual tasks.
			(0 – 3 Marks)	(4 – 6 Marks)	(7 - 9 Marks)	(10 Marks)
Phase 1 Interim Evaluation Total Marks: 20						

EVALUATION RUBRICS for PROJECT Phase I: Final Evaluation

Sl. No.	Parameters	Marks	Poor	Fair	Very Good	Outstanding
1-c	Formulation of Design and/or Methodology and Progress. (Group assessment) [CO1]	5	None of the team members show any evidence of knowledge about the design and the methodology adopted till now/ to be adopted in the later stages. The team has not progressed from the previous stage of evaluation.	The students have some knowledge on the design procedure to be adopted, and the methodologies. However, the team has not made much progress in the design, and yet to catch up with the project plan.	The students are comfortable with design methods adopted, and they have made some progress as per the plan. The methodologies are understood to a large extent.	Shows clear evidence of having a well- defined design methodology and adherence to it. Excellent knowledge in design procedure and its adaptation. Adherence to project plan is commendable.
			(0 – 1 Marks)	(2 – 3 Marks)	(4 Marks)	(5 Marks)
1-d	Individual and Teamwork Leadership (Individual assessment) [CO3]	10	The student does not show any interest in the project activities, and is a passive member.	The student show some interest and participates in some of the activities. However, the activities are mostly easy and superficial in nature.	The student shows very good interest in project, and takes up tasks and attempts to complete them. Shows excellent responsibility and team skills. Supports the other members well.	The student takes a leadership position and supports the other team members and leads the project. Shows clear evidence of leadership.
			(0 – 3 Marks)	(4 – 6 Marks)	(7 - 9 Marks)	(10 Marks)
1-e	Preliminary Analysis/ Modeling / Simulation/ Experiment / Design/ Feasibility study [CO1]	10	The team has not done any preliminary work with respect to the analysis/modeling/ simulation/experiment/design/feasibility study/ algorithm development.	The team has started doing some preliminary work with respect to the project. The students however are not prepared enough for the work and they need to improve a lot.	There is some evidence to show that the team has done good amount of preliminary investigation and design/ analysis/ modeling etc. They can improve further.	Strong evidence for excellent progress in the project. The team has completed the required preliminary work already and are poised to finish the phase I in an excellent manner. They have shown results to prove their progress.
			(0 – 3 Marks)	(4 – 6 Marks)	(7 - 9 Marks)	(10 Marks)

1-f	Documentation and presentation. (Individual & group assessment). [CO6]	5	<p>The team did not document the work at all. The project journal/diary is not presented. The presentation was shallow in content and dull in appearance. The individual student has no idea on the presentation of his/her part.</p>	<p>Some documentation is done, but not extensive. Interaction with the guide is minimal. Presentation include some points of interest, but overall quality needs to be improved. Individual performance to be improved.</p>	<p>Most of the project details were documented well enough. There is scope for improvement. The presentation is satisfactory. Individual performance is good.</p>	<p>The project stages are extensively documented in the report. Professional documentation tools like LaTeX were used to document the progress of the project along with the project journal. The documentation structure is well-planned and can easily grow into the project report.</p> <p>The presentation is done professionally and with great clarity. The individual's performance is excellent.</p>
			(0 – 1 Marks)	(2 – 3 Marks)	(4 Marks)	(5 Marks)
Total		30	Phase - I Final Evaluation Marks: 30			

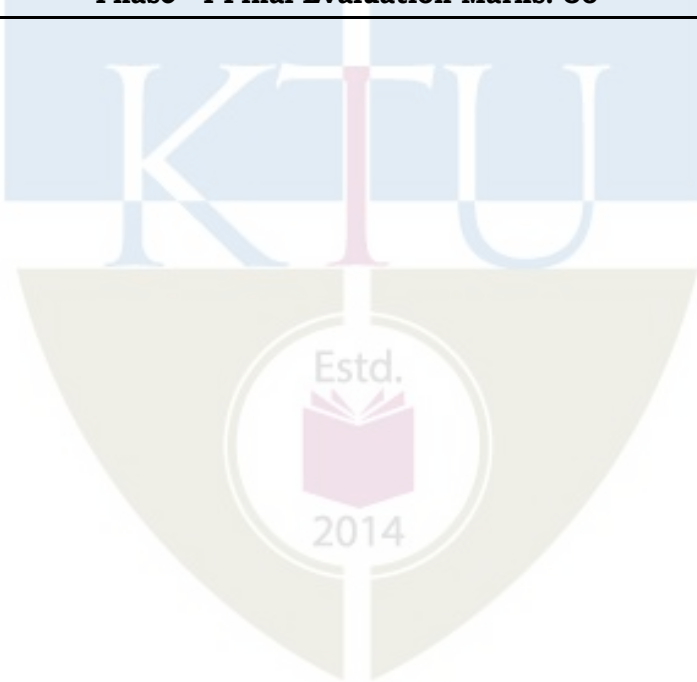

EVALUATION RUBRICS for PROJECT Phase I: Report Evaluation

Sl. No.	Parameters	Marks	Poor	Fair	Very Good	Outstanding
1-g	Report [CO6]	20	The prepared report is shallow and not as per standard format. It does not follow proper organization. Contains mostly Unacknowledged content. Lack of effort in preparation is evident.	Project report follows the standard format to some extent. However, its organization is not very good. Language needs to be improved. All references are not cited properly in the report.	Project report shows evidence of systematic documentation. Report is following the standard format and there are only a few issues. Organization of the report is good. Most of references are cited properly.	The report is exceptionally good. Neatly organized. All references cited properly. Diagrams/Figures, Tables and equations are properly numbered, and listed and clearly shown. Language is excellent and follows standard styles.
			(0 - 7 Marks)	(8 - 12 Marks)	(13 - 19 Marks)	(20 Marks)
Phase - I Project Report Marks: 20						

